

MODEL NUMBER	A in. [mm]	B in. [mm]	C in. [mm]	D in. [mm]	E in. [mm]	F in	G mm
M-INT2-36-6-A	35.4 [900]	70.9 [1800]	6 [152]	31.6 [803]	67.6 [1717]	34.7	881
M-INT2-36-8-A	35.4 [900]	70.9 [1800]	8 [203]	31.6 [803]	67.6 [1717]	36.7	932
M-INT2-38-6-A	35.4 [900]	94.5 [2400]	6 [152]	31.6 [803]	91.6 [2327]	34.7	881
M-INT2-38-8-A	35.4 [900]	94.5 [2400]	12 [305]	31.6 [803]	91.6 [2327]	36.7	932
M-INT2-46-6-A	47.2 [1200]	70.9 [1800]	6 [152]	43.6 [1107]	67.6 [1717]	34.7	881
M-INT2-46-8-A	47.2 [1200]	70.9 [1800]	8 [203]	43.6 [1107]	67.6 [1717]	36.7	932
M-INT2-46-12-A	47.2 [1200]	70.9 [1800]	12 [305]	43.6 [1107]	67.6 [1717]	40.7	1034
M-INT2-47-6-A	47.2 [1200]	82.7 [2100]	6 [152]	43.6 [1107]	79.6 [2022]	34.7	881
M-INT2-47-8-A	47.2 [1200]	82.7 [2100]	8 [203]	43.6 [1107]	79.6 [2022]	36.7	932
M-INT2-47-12-A	47.2 [1200]	82.7 [2100]	12 [305]	43.6 [1107]	79.6 [2022]	40.7	1034
M-INT2-48-6-A	47.2 [1200]	94.5 [2400]	6 [152]	43.6 [1107]	91.6 [2327]	34.7	881
M-INT2-48-8-A	47.2 [1200]	94.5 [2400]	8 [203]	43.6 [1107]	91.6 [2327]	36.7	932
M-INT2-48-12-A	47.2 [1200]	94.5 [2400]	12 [305]	43.6 [1107]	91.6 [2327]	40.7	1034
M-INT2-49-6-A	47.2 [1200]	106.3 [2700]	6 [152]	43.6 [1107]	103.6 [2631]	34.7	881
M-INT2-49-8-A	47.2 [1200]	106.3 [2700]	8 [203]	43.6 [1107]	103.6 [2631]	36.7	932
M-INT2-49-12-A	47.2 [1200]	106.3 [2700]	12 [305]	43.6 [1107]	103.6 [2631]	40.7	1034
M-INT2-410-6-A	47.2 [1200]	118.1 [3000]	6 [152]	43.6 [1107]	115.6 [2936]	34.7	881
M-INT2-410-8-A	47.2 [1200]	118.1 [3000]	8 [203]	43.6 [1107]	115.6 [2936]	36.7	932
M-INT2-410-12-A	47.2 [1200]	118.1 [3000]	12 [305]	43.6 [1107]	115.6 [2936]	40.7	1034
M-INT2-56-6-A	59.06 [1500]	70.9 [1800]	6 [152]	55.6 [1412]	67.6 [1717]	34.7	881
M-INT2-56-8-A	59.06 [1500]	70.9 [1800]	8 [203]	55.6 [1412]	67.6 [1717]	36.7	932
M-INT2-56-12-A	59.06 [1500]	70.9 [1800]	12 [305]	55.6 [1412]	67.6 [1717]	40.7	1034
M-INT2-57-6-A	59.06 [1500]	82.7 [2100]	6 [152]	55.6 [1412]	79.6 [2022]	34.7	881
M-INT2-57-8-A	59.06 [1500]	82.7 [2100]	8 [203]	55.6 [1412]	79.6 [2022]	36.7	932
M-INT2-57-12-A	59.06 [1500]	82.7 [2100]	12 [305]	55.6 [1412]	79.6 [2022]	40.7	1034
M-INT2-58-6-A	59.06 [1500]	94.5 [2400]	6 [152]	55.6 [1412]	91.6 [2327]	34.7	881
M-INT2-58-8-A	59.06 [1500]	94.5 [2400]	8 [203]	55.6 [1412]	91.6 [2327]	36.7	932
M-INT2-58-12-A	59.06 [1500]	94.5 [2400]	12 [305]	55.6 [1412]	91.6 [2327]	40.7	1034
M-INT2-59-6-A	59.06 [1500]	106.3 [2700]	6 [152]	55.6 [1412]	103.6 [2631]	34.7	881
M-INT2-59-8-A	59.06 [1500]	106.3 [2700]	8 [203]	55.6 [1412]	103.6 [2631]	36.7	932
M-INT2-59-12-A	59.06 [1500]	106.3 [2700]	12 [305]	55.6 [1412]	103.6 [2631]	40.7	1034
M-INT2-510-6-A	59.06 [1500]	118.1 [3000]	6 [152]	55.6 [1412]	115.6 [2936]	34.7	881
M-INT2-510-8-A	59.06 [1500]	118.1 [3000]	8 [203]	55.6 [1412]	115.6 [2936]	36.7	932
M-INT2-510-12-A	59.06 [1500]	118.1 [3000]	12 [305]	55.6 [1412]	115.6 [2936]	40.7	1034

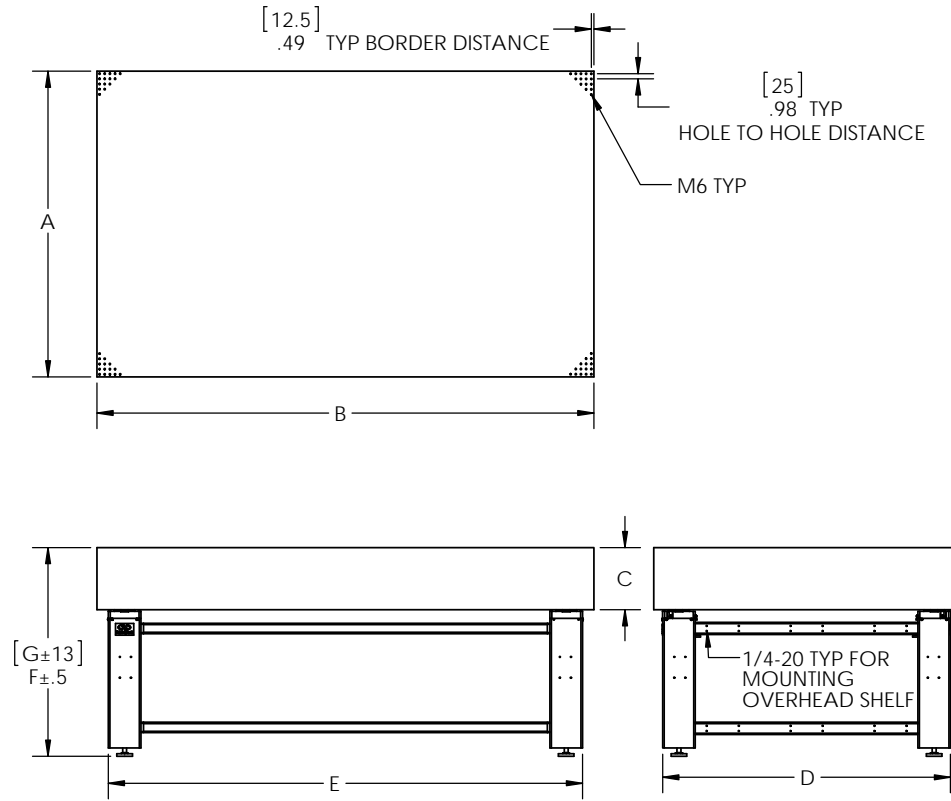

NOTES:

1. M-INT2 OPTICAL TABLE HAS 4.8mm SKIN.
2. DIMS IN [ ] ARE IN mm.