

NA = 0.6

EFL = 2.8 mm

CT = 2.24 mm

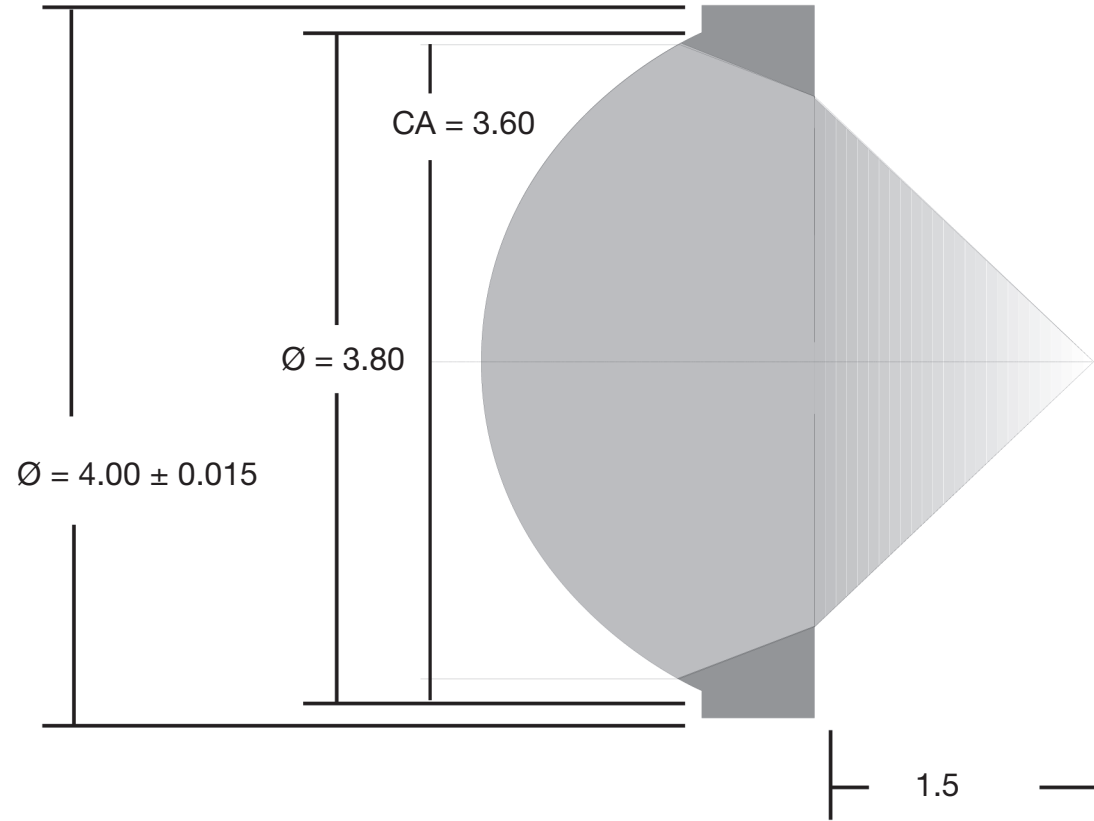

Dimensions in mm