

User's Guide

High Power Laser Diode Mount LDM-4442



 **ILX Lightwave**[®]
A Newport Corporation Brand

ILX Lightwave Corporation · 31950 Frontage Road · Bozeman, MT, U.S.A. 59715 · U.S. & Canada: 1-800-459-9459 · International Inquiries: 406-556-2481 · Fax 406-586-9405

ilx.custhelp.com · www.ilxlightwave.com



TABLE OF CONTENTS



Table of Contents	i
List of Figures	iii
Safety and Warranty Information	v
Safety Information and the Manual	v
General Safety Considerations	v
Safety Symbols	vi
Safety Marking Symbols	vi
Warranty	vii
Chapter 1 Introduction	
Product Overview	1
Specifications	4
Available Option Kits	5
Chapter 2 Operation	
Disassembly	7
Electrical Connections	7
Laser Diode Mounting	11
Current Sources and Current Measurements	11
Configuration Options	12

Chapter 3 Maintenance

Chapter 4 Safety



LIST OF FIGURES



Figure 1.1 LDM-4442 Diagram	3
Figure 2.1 LDM-4442 Wiring Diagram	10
Figure 2.2 TE and Current Cable Pin-Out Diagram (for use with ILX Lightwave Current Sources)	10

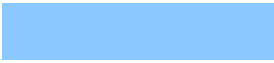

LIST OF FIGURES

SAFETY AND WARRANTY INFORMATION

The Safety and Warranty Information section provides details about cautionary symbols used in the manual, safety markings used on the instrument, and information about the Warranty including Customer Service contact information.

Safety Information and the Manual

Throughout this manual, you will see the words *Caution* and *Warning* indicating potentially dangerous or hazardous situations which, if not avoided, could result in death, serious or minor injury, or damage to the product.

CAUTION

Caution indicates a potentially hazardous situation which can result in minor or moderate injury or damage to the product or equipment.

WARNING

Warning indicates a potentially dangerous situation which can result in serious injury or death.

WARNING

Visible and/or invisible laser radiation. Avoid eye or skin exposure to direct or scattered radiation.

General Safety Considerations

If any of the following conditions exist, or are suspected, do not use the instrument until safe operation can be verified by trained service personnel:

- Visible damage
- Severe transport stress
- Prolonged storage under adverse conditions
- Failure to perform intended measurements or functions

If necessary, return the instrument to ILX Lightwave, or the authorized local ILX Lightwave distributor, for service or repair to ensure that safety features are maintained (see the contact information on page ix).









All instruments returned to ILX Lightwave are required to have a Return Authorization Number assigned by an official representative of ILX Lightwave Corporation. See Returning an Instrument on page vii for more information.

SAFETY SYMBOLS

This section describes the safety symbols and classifications.

Safety Marking Symbols

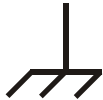
This section provides a description of the safety marking symbols that appear on the instrument. These symbols provide information about potentially dangerous situations which can result in death, injury, or damage to the instrument and other components.

 <p>Caution, refer to manual</p>	 <p>Earth ground Terminal</p>	 <p>Alternating current</p>	 <p>Visible and/or invisible laser radiation</p>
 <p>Caution, risk of electric shock</p>	 <p>Protective Conductor Terminal</p>	 <p>Caution, hot surface</p>	 <p>Frame or chassis Terminal</p>
 <p>On: In position of a bistable push control. The slash (/) only denotes that mains are on.</p> <p>or (/)</p>	 <p>Off: Out position of a bistable push control. The circle (O) only denotes that mains are off.</p> <p>or (O)</p>		

WARRANTY

ILX LIGHTWAVE CORPORATION warrants this instrument to be free from defects in material and workmanship for a period of one year from date of shipment. During the warranty period, ILX will repair or replace the unit, at our option, without charge.

Limitations

This warranty does not apply to fuses, lamps, defects caused by abuse, modifications, or to use of the product for which it was not intended.

This warranty is in lieu of all other warranties, expressed or implied, including any implied warranty of merchantability or fitness for any particular purpose. ILX Lightwave Corporation shall not be liable for any incidental, special, or consequential damages.

If a problem occurs, please contact ILX Lightwave Corporation with the instrument's serial number, and thoroughly describe the nature of the problem.

Returning an Instrument

If an instrument is to be shipped to ILX Lightwave for repair or service, be sure to:

- 1 Obtain a Return Authorization number (RA) from ILX Customer Service.
- 2 Attach a tag to the instrument identifying the owner and indicating the required service or repair. Include the instrument serial number from the rear panel of the instrument.
- 3 Attach the anti-static protective caps that were shipped with the instrument and place the instrument in a protective anti-static bag.
- 4 Place the instrument in the original packing container with at least 3 inches (7.5 cm) of compressible packaging material. **Shipping damage is not covered by this warranty.**
- 5 Secure the packing box with fiber reinforced strapping tape or metal bands.
- 6 Send the instrument, transportation pre-paid, to ILX Lightwave. Clearly write the return authorization number on the outside of the box and on the shipping paperwork. ILX Lightwave recommends you insure the shipment.

If the original shipping container is not available, place the instrument in a container with at least 3 inches (7.5 cm) of compressible packaging material on all sides.

Repairs are made and the instrument returned transportation pre-paid. Repairs are warranted for the remainder of the original warranty or for 90 days, whichever is greater.

Claims for Shipping Damage

When you receive the instrument, inspect it immediately for any damage or shortages on the packing list. If the instrument is damaged, file a claim with the carrier. The factory will supply you with a quotation for estimated costs of repair. You must negotiate and settle with the carrier for the amount of damage.



Comments, Suggestions, and Problems

To ensure that you get the most out of your ILX Lightwave product, we ask that you direct any product operation or service related questions or comments to ILX Lightwave Customer Support. You may contact us in whatever way is most convenient:

Phone (800) 459-9459 or (406) 586-1244

Fax (406) 586-9405

On the web at: ilx.custhelp.com

Or mail to:

ILX Lightwave Corporation
P. O. Box 6310
Bozeman, Montana, U.S.A 59771
www.ilxlightwave.com

When you contact us, please have the following information:

Model Number: _____

Serial Number: _____

End-user Name: _____

Company: _____

Phone: _____

Fax: _____

Description of what is connected to the ILX Lightwave instrument:

Description of the problem:

If ILX Lightwave determines that a return to the factory is necessary, you will be issued a Return Authorization (RA) number. Please mark this number on the outside of the shipping box.

You or your shipping service are responsible for any shipping damage when returning the instrument to ILX Lightwave; ILX recommends you insure the shipment. If the original shipping container is not available, place your instrument in a container with at least 3 inches (7.5 cm) of compressible packaging material on all sides.

We look forward to serving you even better in the future!



WARRANTY

INTRODUCTION



This manual describes the LDM-4442 Laser Diode Mount and explains its operation. Information is also provided to assist in customizing this mount to satisfy specific laser mounting needs. This chapter provides an overview of the LDM-4442 Laser Diode Mount, and contains general information and specifications important in its use.

You should read the entire manual to familiarize yourself with the operation of the LDM-4442 Laser Diode Mount before installing laser diodes.

Product Overview

The LDM-4442 is a high power laser diode mount that provides easy and secure positioning for many of today's popular high output laser diodes. The mount provides a method for locating these lasers above an optical table or rail with a standard mounting pattern.

The LDM-4442 is intended for applications where a laser package dissipates more than 5 watts. The mount can be configured with water cooling for the efficient removal of up to 50 watts of thermal power. Applications which require unobstructed access to the front of the laser package are well suited for the LDM-4442.

The LDM-4442 consists of a base stand, a water-cooled riser, and a heat sink with a cable strain-relief clamp (see Figure 1.1). An assortment of laser mounting plates can be ordered as options to provide easy attachment of different laser packages.

With or without the detachable base stand, the LDM-4442 can be attached directly to optical tables having the standard 1/4-20 on 1" centers, hole pattern. When used with the base stand, the LDM-4442 locates the laser package at a nominal height of 4.0". When the base stand is removed, the riser can be bolted directly to

the table, lowering the laser to 3.5". In either configuration, the laser package is electrically isolated from the table.

The riser is tapped to accept 1/8" pipe thread hose nipples to provide a means of making water connections to the LDM-4442. These fittings are provided in the accessory kit that accompanied the mount.

Figure 1.1 on the following page is an exploded view of the LDM-4442 which identifies major components and illustrates their assembly.

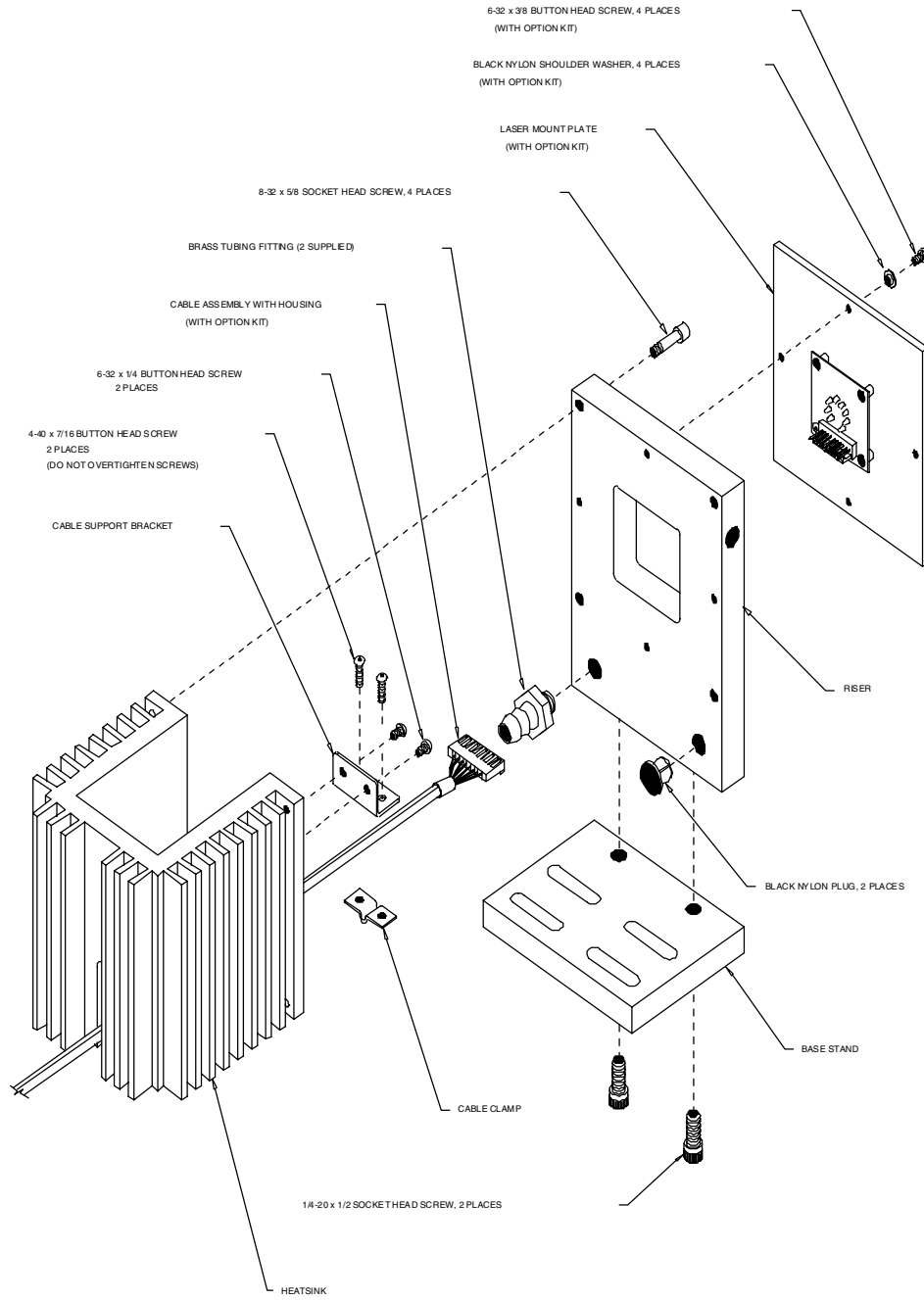

Figure 1.1 LDM-4442 Diagram

Specifications

Beam Height¹

With supplied base stand	101.6mm (4.0") nominal
Without base stand	88.9mm (3.5") nominal

Assembly / Mounting Holes (Riser)

Spacing	2.000 ± 0.005", center to center
---------	----------------------------------

Maximum Heat Dissipation	50W
---------------------------------	-----

Thermal Resistance

Natural Convection	1.4 °C/W typical
Water Cooling ²	0.7 °C/W typical

Mounting Plate Delta T³

Natural Convection	28 °C
Water Cooling ²	15 °C

Laser Diode Connection⁴	10 pin ribbon connector
---	-------------------------

Dimensions	152mm x 102mm x 119mm 6" x 4" x 4.7"
-------------------	---

Weight	1.8 kg (4 lbs)
---------------	----------------

Laser Package Styles	TO-3, HHL, "XT"
-----------------------------	-----------------

1. Laser output centered in the package.
2. 500CC/min water flow, water temperature of 8 °C.
3. With 18W heat load
4. Connections from current sources and temperature controllers user configurable.

Available Option Kits

Option 444201

Laser Mounting Plate - TO-3 (and cabling) Accepts 8-lead TO-3 style packages - Spectra Diode Labs "H" Series; Sony "W" or "WT" Series

Option 444202

Laser Mounting Plate - HHL Accepts HHL Package

Option 444203

Laser Mounting Plate - Sony (and cabling) Accepts Sony "XT" Package

Option 444204

Laser Mounting Plate - Blank Blank mounting plate that can be machined to accept most popular laser diode packages; no connectors or interface PCB is supplied with this option.

Cabling (supplied with each option kit)

Types Two single-end connectors; one DB-9 male, one DB-15 male; unhused Molex pin terminations

OPERATION

This chapter describes the electrical connection and mounting of laser diodes. Configuration options for the LDM-4442 and its laser mounting plates are also discussed.

Disassembly

The 4442 is easily disassembled by removing the socket head screws at the bottom of the mount (see Figure 1.1). This will separate (disassemble) the riser from the base stand. Remove the laser mount plate by removing the four isolated screws at the front of the plate. In order to disconnect the plate from the cable, it is recommended that the two cable clamp retaining screws be loosened at the rear of the heat sink. Be sure to save the black shoulder washers for reassembly.

The heat sink may then be removed by unscrewing the four 8-32 socket head screws from the front of the riser. The tan-colored thermal pad on the riser is meant to be permanently affixed to that surface and should not be removed. Similar instructions apply to the two pads on the heat sink.

Electrical Connections

CAUTION

Laser diodes are extremely susceptible to damage caused by electrostatic discharge and surge currents. To avoid early failure or damage to the device, workers and work benches must be grounded at all times when handling or working with laser diodes.

Figure 2.1 shows the wiring of the 4442 and Figure 2.2 shows the pin assignments for the 9-pin and 15-pin cable assemblies that are provided with each laser plate option ordered. You should refer to Section 2.4 to familiarize yourself with Laser Diode Mounting before attempting to mount or connect lasers.

The cable assemblies provided with each option are terminated with contacts, but are not housed. This allows flexibility in connecting lasers with different pin configurations. Refer to the laser manufacturer's pin connection diagram, Figure 2.1 and Figure 2.2 to determine the correct housing configuration for a particular laser application.

As an example, two lasers are listed in Table 2.1, with their appropriate connector housing configuration and the associated cable wiring.

Table 2.1 Laser Connection Data

"H" Series TO-3 Package			HHL Series Package	
Function	Wire	Housing Pin #	Wire	Function
N/C		1	TE-White	TE Module (-)
Laser Cathode	LD-White	2		Case
Thermistor	TE-White	3	LD-Black/Red	Laser Anode
Thermistor	TE-Orange	4	TE-Orange	Thermistor
TE Module (+)	TE-Brown/Red	5	TE-White	Thermistor
TE Module (-)	TE-White	6	LD-White	Laser Cathode
PD Cathode	LD-White	7	LD-Orange	Monitor PD Anode (+)
PD Anode	LD-Orange	8	LD-White	Monitor PD Cathode (-)
Laser Anode	LD-Black/Red	9	TE-Brown/Red	TEC (+)
N/C		10		N/C

LD = Laser Diode Current Cable

TE = Thermoelectric Control Cable

PD = Photodiode

N/C = No Connection

The LDM-4442 Laser Diode Mount may be operated with the ILX Lightwave LDC-3744B Laser Diode Controller or equivalent. Once the LDM-4442 is wired for operation with an ILX instrument, the mount will be interchangeable with all current sources and temperature controllers manufactured by ILX. If an ILX Lightwave current source is used with the system interlock feature, the interlock connections are available at pins 1 and 2 of the current source connector. With the ILX Lightwave interlock feature enabled, the interlock pins must be connected before current can flow from the source.

CAUTION

Do not exceed the specified current settings of the laser. Do not exceed the maximum drive current under any circumstances.

If you are using an ILX Lightwave current source, or any other current source which has an adjustable limit setting, set the current limit to a safe level for your laser. Refer to the instruction manual for your current source if necessary.

The ground lug in the accessory kit for the mount is provided for ease of connecting the laser case to an available earth ground. The lug can be crimped onto any 14 to 16 AWG wire.

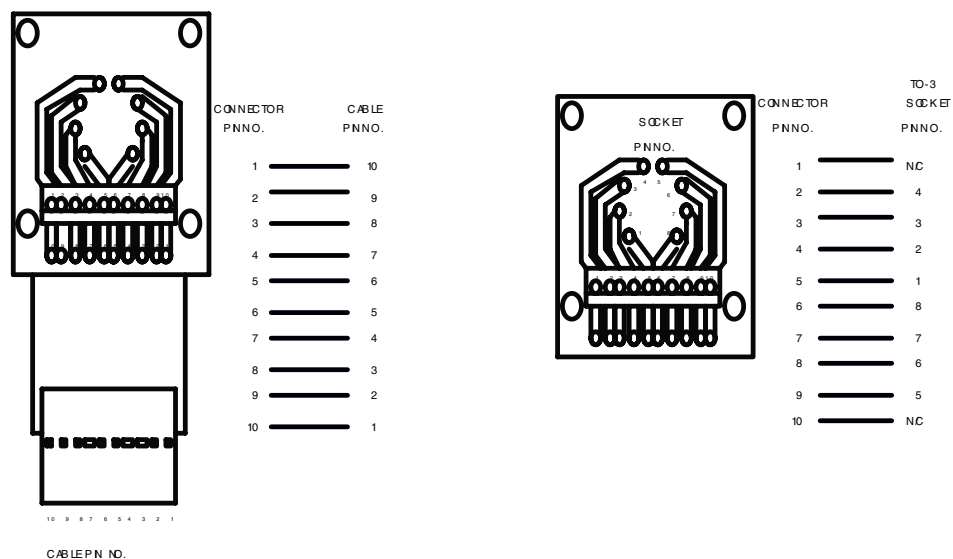

Figure 2.1 LDM-4442 Wiring Diagram

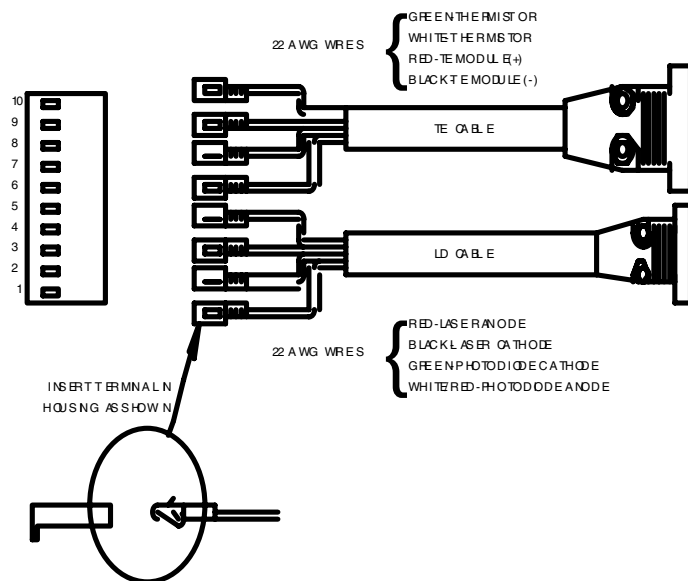

Figure 2.2 TE and Current Cable Pin-Out Diagram
(for use with ILX Lightwave Current Sources)

Laser Diode Mounting

CAUTION

Laser diodes are extremely susceptible to damage caused by electrostatic discharge and surge currents. To avoid early failure or damage to the device, workers and work benches must be grounded at all times when handling or working with laser diodes.

The riser of the LDM-4442 is designed to be electrically isolated from its Laser Mounting Plate and the laser diode package which is attached. Do not defeat this isolation by attempting to operate the laser with the tan-colored thermal pad or the Screw Insulators (in the laser plate mounting holes) removed. The riser of the LDM-4442 is electrically connected to the base stand.

Laser diodes may be mounted on the LDM-4442 with or without the laser mount plate attached to the riser. To mount a laser diode, follow these steps.

- 1 Locate the mounting screws for the laser package in the laser plate kit.
- 2 Position the laser package on the front surface of the laser mount plate. For TO-3 style packages, feed the leads carefully through the holes in the plate and into the sockets behind the plate.
- 3 To secure the laser package, tighten the mounting screws firmly.
- 4 On rectangular packages, lightly fold the cable down, and connect to the pins on the bottom of the package.

Note: On packages with less than 10 pins, the connector should be centered about the pins, i.e. for an 8-pin package, the 2 outer sockets on the connector should not be connected.

Current Sources and Current Measurements

If it is necessary to measure the current to your laser during operation, follow these steps:

- 1 NEVER connect an ammeter in series with the laser circuit.
- 2 Place a known resistance (1 ohm works well) in series with the laser diode circuit. Then, measure the voltage across the resistor. Calculate the current by using Ohm's law, $I = E / R$.
- 3 NEVER turn the voltmeter on or off, or change the voltage measurement range, while current is flowing to the laser. These actions could result in destruction of your laser diode.

ILX Lightwave current sources allow the user to read the output current during laser operation. Therefore, it is not necessary to measure the laser current as described above.

 **CAUTION**

Viewing of emissions may cause severe and permanent eye damage. Use of protective goggles is recommended when operating these lasers.

Configuration Options

In some cases, you may prefer to use this laser mount without the base stand. When mounting to some other support, remove the two 1/4-20 x 1/2" assembly bolts and replace them with bolts suited to your particular application. Note that the assembly/mounting holes in the riser are centered 2.000 ± 0.005 inches apart. When the LDM-4442 is used without the base stand, the center of the laser package is at a nominal height of 3.5 inches above the supporting surface.

The LDM-4442 that you received is configured for use as a natural convection heat sink. However, the mount can be set up for water cooling which will lower the operating temperature of laser case and provide extended heat dissipation. This is accomplished by attaching the brass hose fittings supplied with the mount. Remove the plastic hole plugs at the bottom rear of the riser. Apply teflon tape or a pipe sealant to the threads of each fitting, and attach them to the mount. Connect 1/4" I.D. flexible tubing to each fitting and to a water source and drain. A 500 cc/min flow of 10 °C water is adequate for most high power applications. If higher performance is required, the flow and/or the water temperature (through a chiller) can be adjusted.

MAINTENANCE



No maintenance procedures are required for the LDM-4442 other than an occasional cleaning, as needed, to remove any accumulated dust or dirt from the external surfaces.

SAFETY

Laser diodes used with the LDM-4442 Laser Diode Mount may emit infrared radiation which is invisible to the human eye. Extreme care must be taken to prevent the beam from being viewed either directly or through external optics or mirrors. Remove rings, jewelry, and other reflective materials when working with lasers.

 **CAUTION**

Viewing of emissions may cause severe and permanent eye damage. Use of protective goggles is recommended when operating these lasers.

To align the beam, use a phosphor card or infrared viewer. Note the maximum possible output listed in the specifications of your laser. In addition to using great care in applying proper drive current, appropriate precautions must be taken to avoid potentially harmful exposure.

 **CAUTION**

Lasers and Laser Mounting Plates should never be installed or removed while the laser is in operation. Doing so could expose the user to dangerous levels of direct or reflected laser radiation.

 **CAUTION**

Use of controls or adjustments or performance of procedures other than those specified herein may result in hazardous radiation exposure.

This product conforms to all applicable DHHS regulations 21 CFR Subchapter J, at the date of manufacture.

