

**Models 2001 and 2011**

**User's Manual**

---

**Front-End Optical Receivers**

**【*ν*】**



**Warranty**

New Focus, Inc. guarantees its products to be free of defects for one year from the date of shipment. This is in lieu of all other guarantees, expressed or implied, and does not cover incidental or consequential loss.

<b>Contents</b>	<b>Warranty</b>	<b>3</b>
	<b>Introduction</b>	<b>4</b>
	<b>Theory</b>	<b>6</b>
	<b>Operation</b>	<b>14</b>
	<b>Appendix 1:</b>	
	Optical Input	<b>16</b>
	<b>Appendix 2:</b>	
	Electrical Output	<b>16</b>
	<b>Specifications</b>	<b>19</b>

## Introduction

With the New Focus front-end optical receivers you can measure optical signals conveniently and accurately. These photoreceivers are optimized for versatility and efficient operation. New Focus offers two different models to match your wavelength requirements; Table 1 lists each model's characteristics and specifications. Both models have adjustable high- and low-pass filters as well as a 90-dB adjustable electronic gain range to allow shot-noise-limited detection at almost any optical power level from 1  $\mu\text{W}$  to 10 mW. The DC  $\div 30$  setting prevents your signal from going off-scale due to DC-amplitude fluctuations. Model 2001 has a noise equivalent power (NEP) of less than 1  $\text{pW}/\sqrt{\text{Hz}}$  from 400 nm to 1060 nm on the  $10^4$  scale. Model 2011 has an NEP of less than 0.5  $\text{pW}/\sqrt{\text{Hz}}$  from 800 nm to 1600 nm on the  $10^4$  scale. Both models maintain a static current drain of less than 1 mA which allows a pair of 9-V batteries to operate for at least 500 hours.

**Table 1*****Characteristics of the  
Front-end Optical Receivers.***

<b>Model Number</b>	<b>2001</b>	<b>2011</b>
<b>Wavelength Range</b>	400–1060 nm	800–1600 nm
<b>Photodiode Material</b>	Silicon	InGaAs
<b>Photodiode Size</b>	0.81 mm <sup>2</sup>	0.09 mm <sup>2</sup>

## Theory

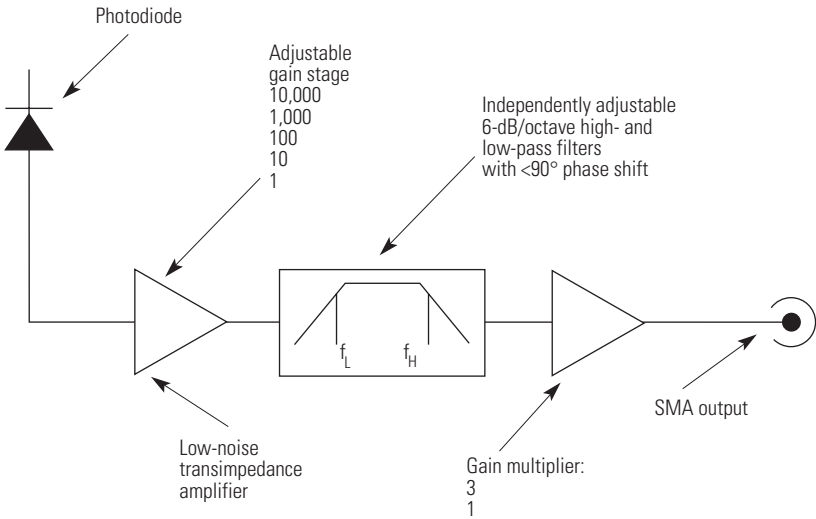
A block diagram of Models 2001 and 2011 is shown in Figure 1. The photoreceiver consists of a photodiode followed by a transimpedance amplifier, two adjustable filters, and a final gain multiplier (Fig. 1). The responsivity of the silicon photodiode for the Model 2001 is shown in Fig. 2. The response factor (V/mW) which is a calibration term that converts measured electrical power to incident optical power at a specific wavelength is shown in Fig. 3 for the Model 2001. The optical power striking the photodetector is equal to the voltage measured divided by the product of the gain knob setting, multiplier factor (1 or 3) and the wavelength response factor. (see Appendix 1: Optical Input for a specific example.) Figs. 4 and 5 show the responsivity and response factor for the InGaAs photodetector in the Model 2011.

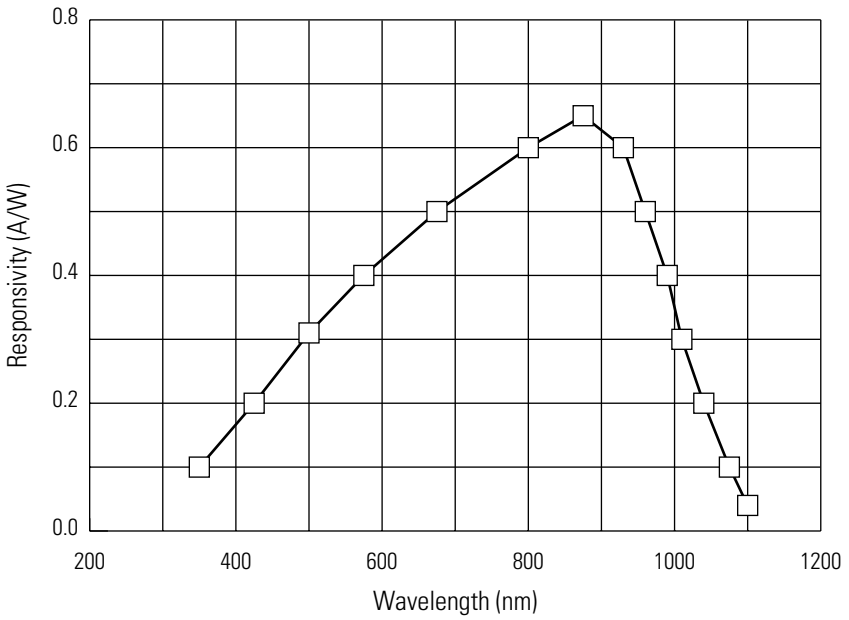
The noise performance of the Models 2001 and 2011 is determined by the setting of the first stage while the final gain stage simply scales the signal for ease of viewing. The NEP is the amount of optical input power required for the output signal to just equal the output noise of the optical receiver. It is a measure of the weakest optical signal and is a function of the wavelength. The NEP as a function of wavelength on the  $10^4$  gain setting is shown in Fig. 6 for Model 2001 and in Fig. 7 for Model 2011. The NEP increases by a factor of approximately three for each full clockwise turn of the gain knob.

Both the photodiode and the circuit are powered from a  $\pm 9$ -V supply provided by two 9-V alkaline batteries.

**Fig. 1**

***Functional block diagram of the front-end optical receiver photoreceivers.***

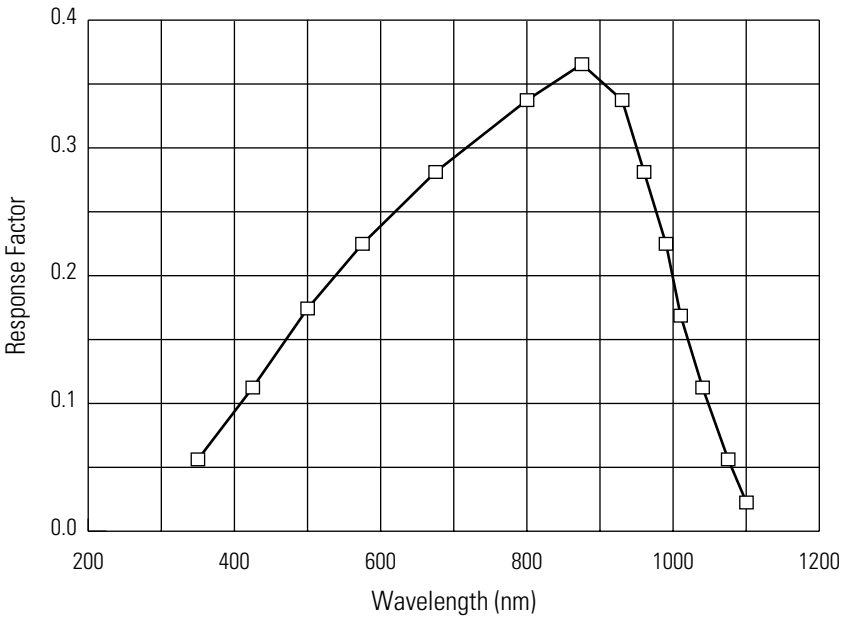


**Fig. 2*****Responsivity of Model 2001.***



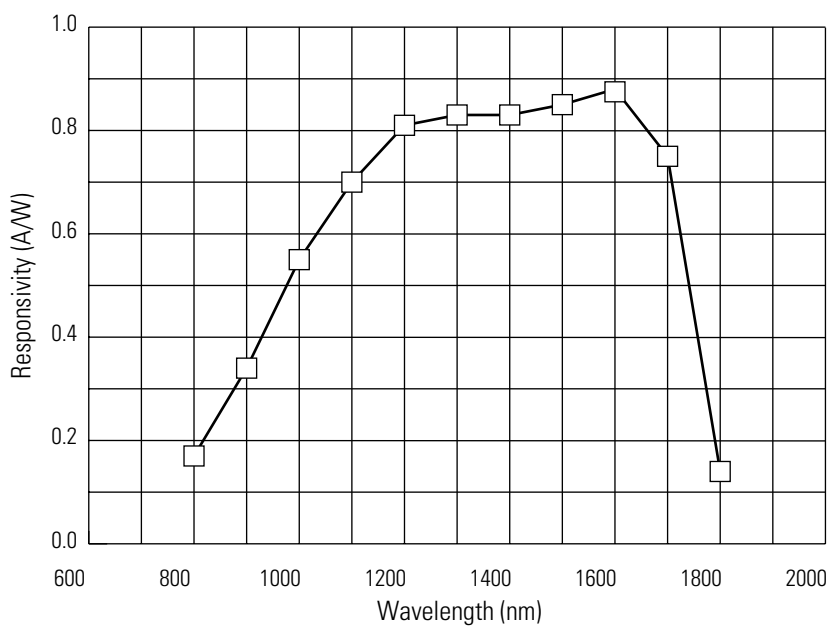
**Fig. 3**

*Response factor versus wavelength  
for the Model 2001.*



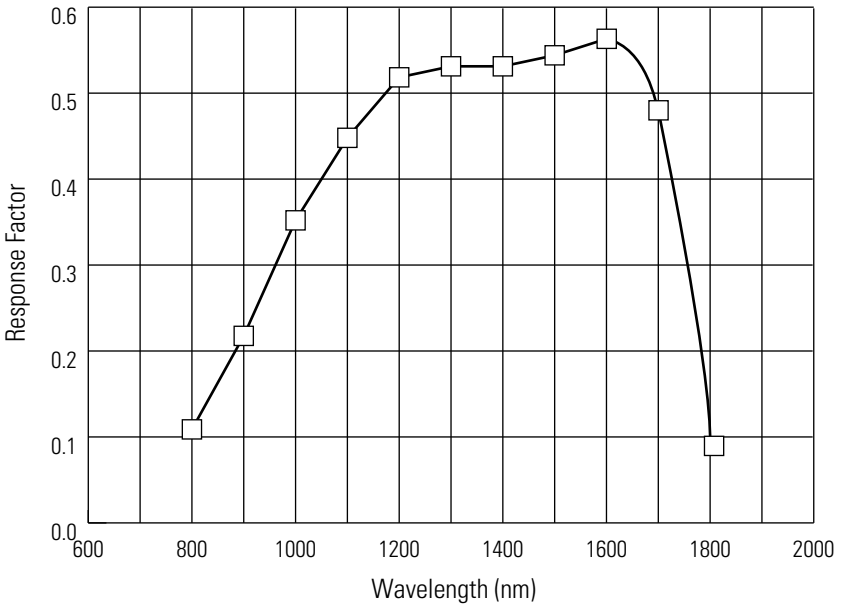
**Fig. 4**

*Responsivity of the Model 2011*



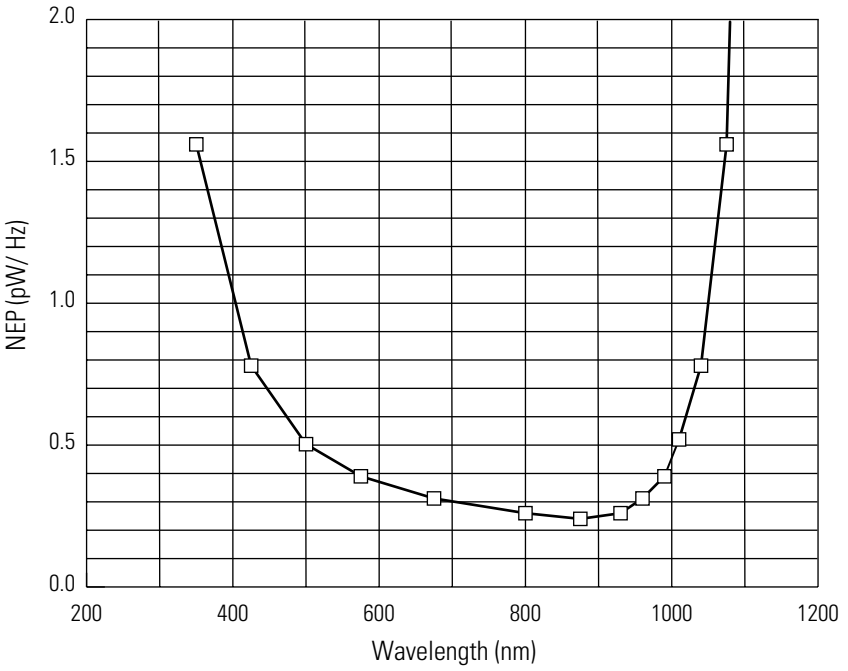
**Fig. 5**

*Response factor versus wavelength for the Model 2011*



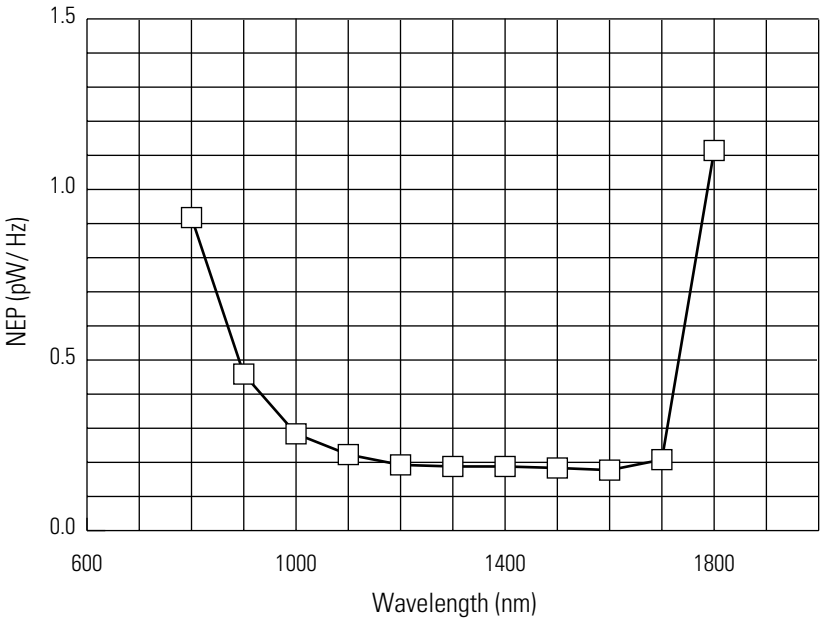
**Fig. 6**

*NEP as a function of wavelength for Model 2001 (at  $10^4$  Gain Setting).*



**Fig. 7**

*NEP as a function of wavelength for Model 2011 (at  $10^4$  Gain Setting).*



**To check the two batteries:**

1. Turn on the photoreceiver using the power switch.
2. Set the Low Frequency Adjust knob to DC.
3. Set the Gain knob to  $10^4 \times 3$  setting.
4. Focus at least  $100 \mu\text{W}$  of optical power on the detector (or place the detector in front of a desk lamp).

The output should be greater than 7 V. If it is not, replace the batteries with fresh ones.

**To replace the batteries:**

The photoreceivers are shipped with two fresh 9-V batteries installed. To avoid confusion about how much life is left in the batteries, replace the batteries on a monthly basis when the unit is in frequent use.

1. Turn off the photoreceiver using the power switch.
2. Use a Phillips head screw driver to remove the two screws on the back panel of the photoreceiver (see the figure in the Specifications).
3. Remove the back panel.
4. Replace the used 9-V batteries with fresh ones.
5. Replace the back panel and the two screws.
6. Recheck the battery level as described above.

## **Tuning the position and frequency of the optical output:**

1. Use the 8-32 (M4) tapped hole located on the base of the photoreceiver to mount it on an adjustment positioning device for alignment of the optical spot on the photodetector diode located on the back side of the unit.
2. Position the mounted photoreceiver in front of the focusing lens.

A simple 25-mm focal length biconvex singlet should be adequate for most applications.

3. Turn on the optical beam.
4. Connect the SMA port on the front of the photoreceiver to a voltmeter.
5. Align the detector to the beam until the output peaks on the voltmeter.
6. Adjust the gain for optimal performance:  
Refer to the discussion in Appendix 2: Electrical Output.
  - Set the Low Frequency Adjustment knob to DC.
  - Set the Gain knob to the full clockwise position.
  - Set the Multiplier to “ $\times 1$ ”.
  - Turn the Gain knob clockwise to increase it until you measure approximately 2 V on the voltmeter.

## Appendix 1:

### *Optical Input*

The optical input power striking the photodetector is equal to the measured voltage divided by the product of the gain knob setting times the multiplier [1 or 3] times the wavelength response factor. For example, with these settings:

Gain knob:  $10^4$

Gain multiplier:  $\times 3$

Response factor: 0.25 Volts/mW

DC output voltage : 2 V.

The optical input power therefore is equal to  $2 \text{ V} / (10^4 \times 3 \times 0.25) = 270 \text{ nW}$ .

## Appendix 2:

### *Electrical Output*

The photoreceiver has three knobs: a low-frequency corner, a high-frequency corner and a gain knob, as well as a gain-multiplier switch.

#### **Frequency Knobs**

The upper left knob adjusts the low-frequency corner and the upper right knob adjusts the high-frequency corner. The corner frequency is the frequency where the response is down by 3 dB from its mid-band value. Fig. 8 depicts the frequency response with a roll-off at 6 dB/octave below the low corner and above the high corner. To obtain



signals over the full bandwidth, set the low corner-frequency knob to its full counterclockwise position and set the high corner-frequency knob to its full clockwise position. The corner frequency increases by a factor of three with each full clockwise turn. The photoreceivers have ten settings for each frequency corner, creating a wide variety of frequency responses. If the low-frequency corner is set higher than or equal to the high-frequency corner, there will be significant attenuation at all frequencies.

In addition, the low-frequency knob has a DC  $\div$  30 setting. This is a convenient setting for observing a small AC signal on a widely varying DC component. It will prevent your signal from going off-scale due to DC amplitude fluctuations.

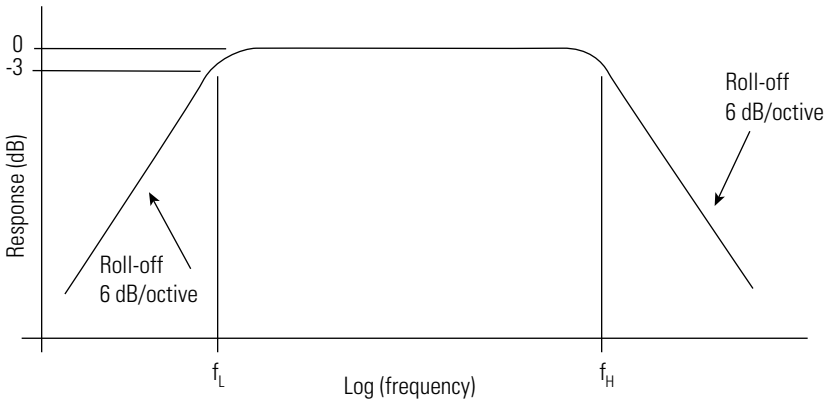
**Note:** With the most sensitive gain setting ( $10^4$ ) the maximum bandwidth is reduced to 20 kHz.

### **Gain Knob**

The overall gain is the product of the gain knob setting and the wavelength response factor (V/mW) indicated on the front of the unit. You can increase the gain by a factor of three by setting the Gain Multiplier Switch to “ $\times 3$ .”

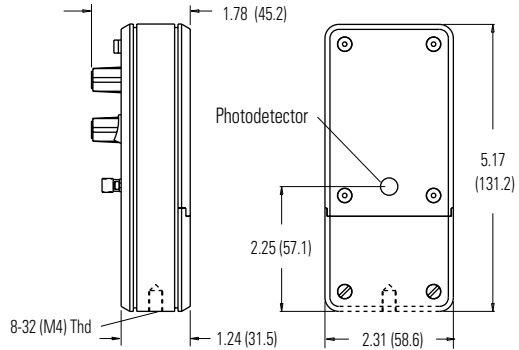
**Fig. 8**

*Setting the frequency response of the Front-end Optical Receivers*



# Specifications

## *Dimensional*



## *Performance*

### *Model 2001*

Responsivity Peak:	0.6 A/W
Conversion Gain Peak:	$1.1 \times 10^7$ V/W
NEP (on the $10^4$ scale):	$1.0 \text{ pW}/\sqrt{\text{Hz}}$

### *Model 2011*

Responsivity Peak:	0.8 A/W
Conversion Gain Peak:	$1.5 \times 10^7$ V/W
NEP (on the $10^4$ scale):	$0.5 \text{ pW}/\sqrt{\text{Hz}}$

### **Accuracy**

Absolute:	20%
Range to Range Consistency:	5% from $10^4$ to $10^3$ 2% at other settings
Frequency Response:	User definable from DC to $>100 \text{ kHz}$ on most gain settings

