

NA = 0.6

EFL = 4.0 mm

CT = 3.04 mm

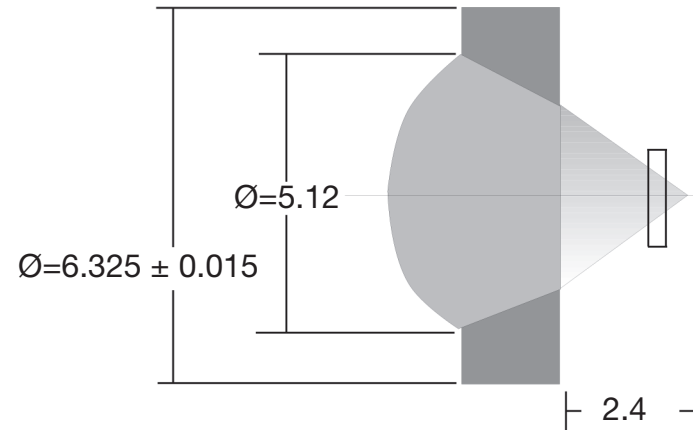

Dimensions in mm