

NA = 0.5

EFL = 3.0 mm

CT = 2.50 mm

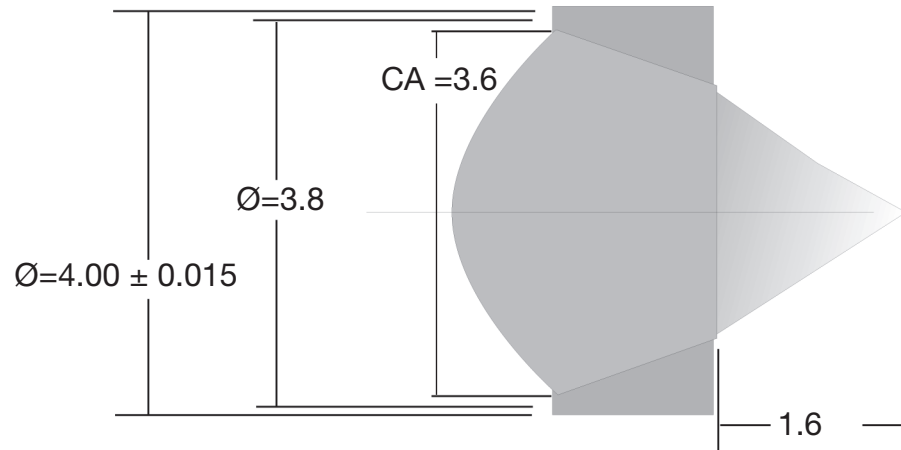

Dimensions in mm