

NA = 0.3

EFL = 3.0 mm

CT = 4.07 mm

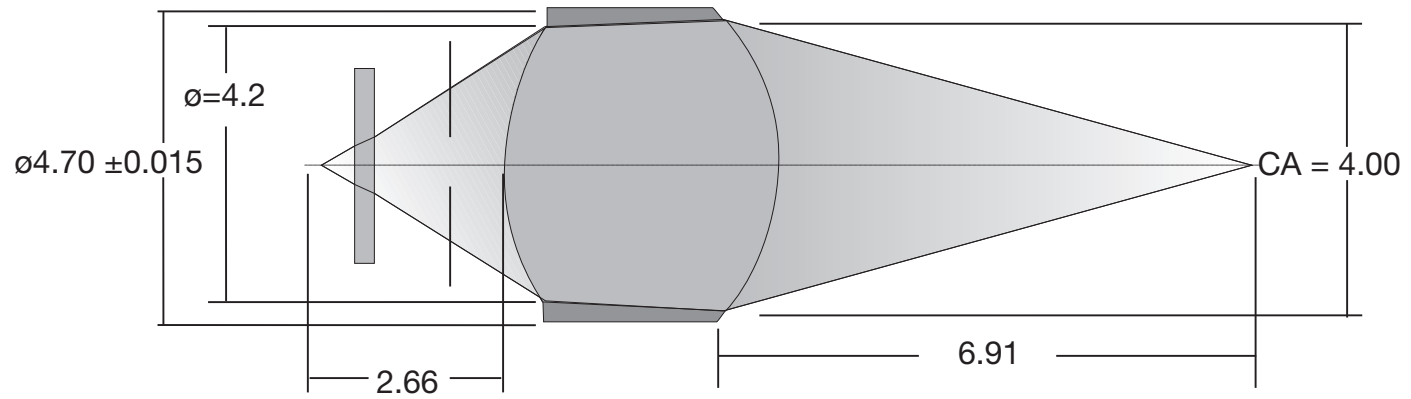

Dimensions in mm