

NA = 0.5

EFL = 8.0 mm

CT = 3.69 mm

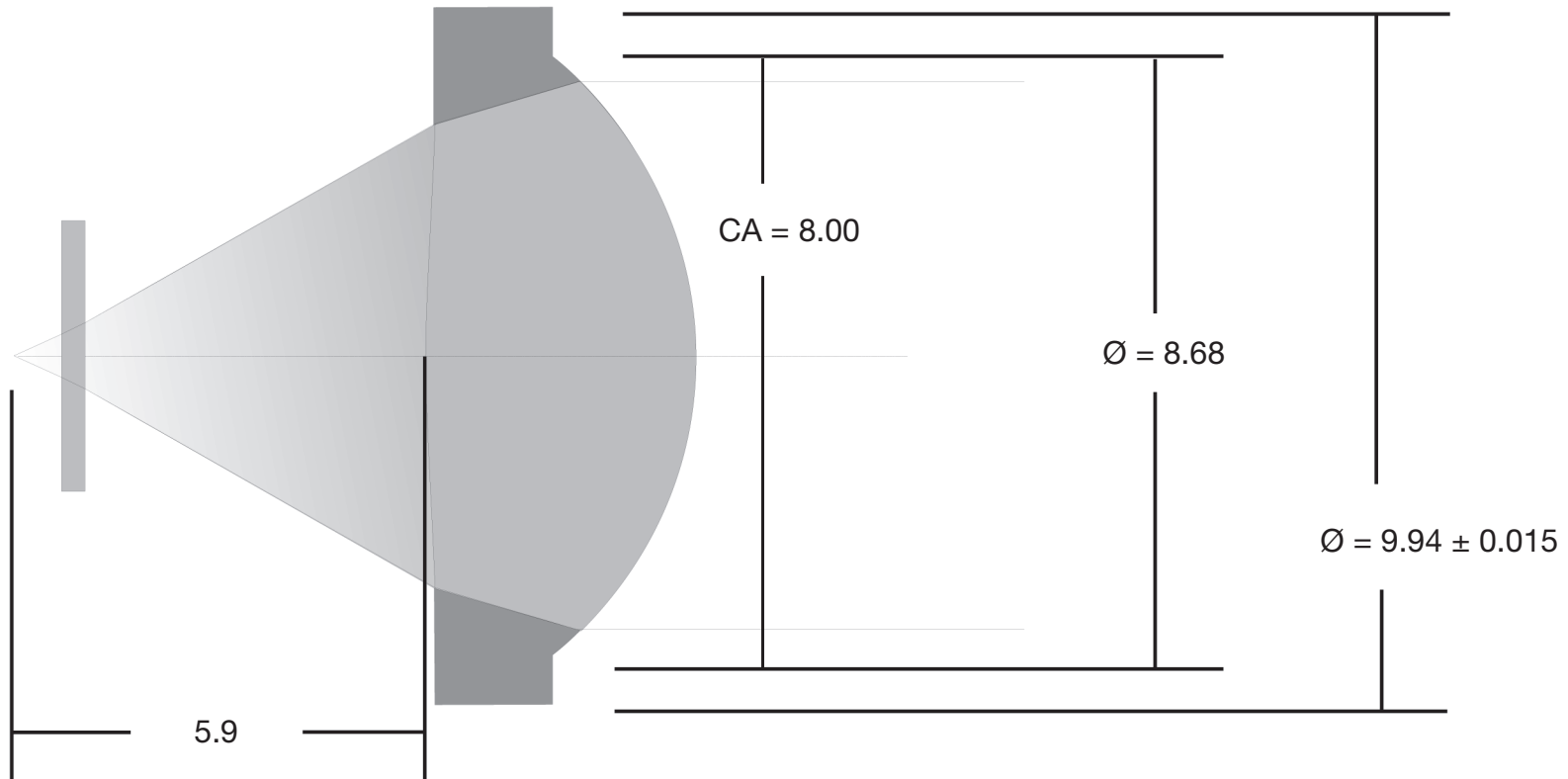

Dimensions in mm