

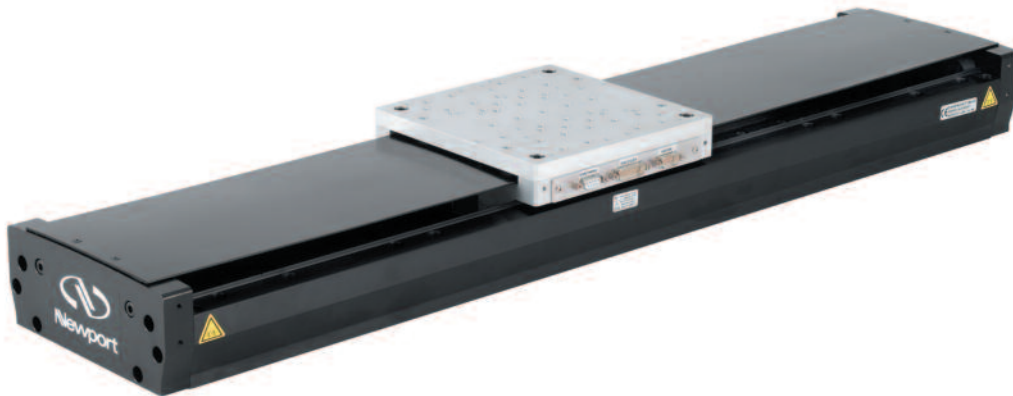

IMS-LM-S Series

High-Performance Long-Travel Linear Motor Stages



 **Newport®**

USER'S MANUAL

Warranty

Newport Corporation warrants this product to be free from defects in material and workmanship for a period of 1 year from the date of shipment. If found to be defective during the warranty period, the product will either be repaired or replaced at Newport's discretion.

To exercise this warranty, write or call your local Newport representative, or contact Newport headquarters in Irvine, California. You will be given prompt assistance and return instructions. Send the instrument, transportation prepaid, to the indicated service facility. Repairs will be made and the instrument returned, transportation prepaid. Repaired products are warranted for the balance of the original warranty period, or at least 90 days.

Limitation of Warranty

This warranty does not apply to defects resulting from modification or misuse of any product or part.

CAUTION

Warranty does not apply to damages resulting from:

- **Incorrect usage:**
 - **Load on the stage greater than maximum specified load.**
 - **Carriage speed higher than specified speed.**
 - **Improper grounding.**
 - **Connectors must be properly secured.**
 - **When the load on the stage represents an electrical risk, it must be connected to ground.**
 - **Excessive or improper cantilever loads.**
- **Modification of the stage or any part thereof.**

This warranty is in lieu of all other warranties, expressed or implied, including any implied warranty of merchantability or fitness for a particular use. Newport Corporation shall not be liable for any indirect, special, or consequential damages.

© 2018 by Newport Corporation, Irvine, CA. All rights reserved.

Original instructions.

No part of this document may be reproduced or copied without the prior written approval of Newport Corporation. This document is provided for information only, and product specifications are subject to change without notice. Any change will be reflected in future publishings.



CAUTION

Please return equipment in the original (or equivalent) packing.

You will be responsible for damage incurred from inadequate packaging if the original packaging is not used.

Table of Contents

Warranty	ii
EC Declaration of Conformity.....	v
Definitions and Symbols.....	vi
Warnings	vii
Caution	ix
<hr/>	
1.0 — Introduction.....	1
<hr/>	
2.0 — Description	2
2.1 Design Details	2
<hr/>	
3.0 — Characteristics.....	3
3.1 Definitions	3
3.2 Mechanical Specifications	4
3.3 Hard Stop: Speed Limitation Versus Load	5
3.4 Load Characteristics and Stiffness	5
3.5 Stage Weights	5
<hr/>	
4.0 — Drive and Motor.....	6
4.1 Motor characteristics	6
4.2 Command Signals.....	6
4.3 Sensor Positions.....	7
4.4 Position Feedback Signals.....	7
4.5 Pinouts.....	8
Motor Connector (P1)	8
Encoder Connector (P2)	8
End-of-Runs & Thermistor Connector (P3).....	9
4.6 Cables	9
<hr/>	
5.0 — Stage Installation.....	10
5.1 Unpacking	10
5.2 Mounting Conditions	10
<hr/>	
6.0 — Connection to Newport Controllers.....	11
6.1 Operating with Newport Controllers/Drives	11
6.2 Warnings on Controllers	11
6.3 Connection.....	12
6.4 Wiring	12

7.0	— Connection to Non-Newport Controllers	13
7.1	Connections	13
<hr/>		
8.0	— Dimensions	14
8.1	(M-)IMS-LM-S Stages	14
8.2	Top Plate Interfaces	15
	IMS-LM-S Stages Top Plate Interface	15
	M-IMS-LM-S Stages Top Plate Interface	15
8.3	Cable Chains	16
<hr/>		
9.0	— Maintenance	17
9.1	Maintenance	17
9.2	Repair	17
9.3	Calibration	17
<hr/>		
	Service Form	19

EC Declaration of Conformity

IMS-LM-S Series



EU Declaration of Conformity

following Annex II-1A
of Directive 2006/42/EC on machinery

The manufacturer:

MICRO-CONTROLE Spectra-Physics,
9, rue du bois sauvage
F-91055 Evry FRANCE

Hereby declares that the machinery:

- Description: " IMS-LM-S "
- Function: High performance linear stage
- Models: M-/IMS300/400/500/600/LM-S

– the technical file of which was compiled by:

Mr Hervé LE COINTE , Quality Director,
MICRO-CONTROLE Spectra-Physics, Zone Industrielle - B.P.29
F-45340 Beaune La Rolande France

- complies with all the relevant provisions of the Directive 2006/42/EC on machinery.
- complies with all the relevant provisions of the Directive 2014/30/EU relating to electro-magnetic compatibility.
- complies with all the relevant provisions of the Directive 2011/65/EU relating to RoHS2.

– was designed and built in accordance with the following harmonised standards:

- NF EN 61326-1:2013 « Electrical equipment for measurement, control and laboratory use – EMC requirements – Part 1: General requirements »
- NF EN 55011:2010/A1:2011 Class A
- EN ISO 60204-1 « Safety of machinery – Electrical equipment of machines – Part 1 General requirements »

– was designed and built in accordance with the following other standards:

- NF EN 61000-4-2
- NF EN 61000-4-3
- NF EN 61000-4-4
- NF EN 61000-4-6
- NF EN 61000-4-8

ORIGINAL DECLARATION

Done in Beaune La Rolande on 16 May 2017
Hervé LE COINTE
Quality Director

DC1-EN rev:A

Definitions and Symbols

The following terms and symbols are used in this documentation and also appear on the product where safety-related issues occur.

General Warning or Caution



The exclamation symbol may appear in warning and caution tables in this document. This symbol designates an area where personal injury or damage to the equipment is possible.

The following are definitions of the Warnings, Cautions and Notes that may be used in this manual to call attention to important information regarding personal safety, safety and preservation of the equipment, or important tips.



WARNING

Warning indicates a potentially dangerous situation which can result in bodily harm or death.



CAUTION

Caution indicates a potentially hazardous situation which can result in damage to product or equipment.

NOTE

Note indicates additional information that must be considered by the user or operator.

European Union CE Mark



The presence of the CE Mark on Newport Corporation equipment means that it has been designed, tested and certified as complying with all applicable European Union (CE) regulations and recommendations.

Warnings and Cautions



ATTENTION

This stage is a Class A device. In a residential environment, this device can cause electromagnetic interference. In this case, suitable measures must be taken by the user.

WARNING

When the IMS-LM-S stage is installed or combined with other instruments in a machine, additional testing to directive 2006/42/EC may be required. It is the responsibility of the end-user or integrator to perform a risk-analysis and the necessary tests to conform to the EC directives.

Newport is not liable for damages caused by not executing this responsibility.

Warnings

WARNING

The motion of objects of all types carries potential risks for operators. Ensure the protection of operators by prohibiting access to the dangerous area and by informing the personnel of the potential risks involved.

WARNING

The magnetic channel included in this device has the potential to disrupt pacemakers. Consequently, it is recommended that individuals maintain a distance of 1 meter or more from the stage as a precautionary measure.

WARNING

Do not use this stage when its motor is emitting smoke or is unusually hot to the touch or is emitting any unusual odor or noise or is in any other abnormal state.

Stop using the stage immediately, switch off the motor power and then disconnect the electronics power supply.



After checking that smoke is no longer being emitted contact your Newport service facility and request repairs. Never attempt to repair the stage yourself as this can be dangerous.

WARNING

Make sure that this stage is not exposed to moisture and that liquid does not get into the stage.

Nevertheless, if any liquid has entered the stage, switch off the motor power and then disconnect the electronics from power supply.

Contact your Newport service facility and request repairs.

WARNING

Do not insert or drop objects into this stage, this may cause an electric shock, or lock the drive.

Do not use this stage if any foreign objects have entered the stage. Switch off the motor power and then disconnect the electronics power supply.

Contact your Newport service facility for repairs.

WARNING

Do not place this stage in unstable locations such as on a wobbly table or sloping surface, where it may fall or tip over and cause injury.

If this stage has been dropped or the case has been damaged, switch off the motor power and then disconnect the electronics power supply.

Contact your Newport service facility and request repairs.

WARNING

Do not attempt to modify this stage; this may cause an electric shock or downgrade its performance.

WARNING

Do not exceed the usable depth indicated on the mounting holes (see section “Dimensions”). Longer screws can damage the mechanics or cause a short-circuit.

WARNING

Do not exceed speed and load limitations as specified in this manual.

Caution

CAUTION

Do not place this stage in a hostile environment such as X-Rays, hard UV,... or in any vacuum environment.

CAUTION

Do not place this stage in a location affected by dust, oil fumes, steam or high humidity. This may cause an electric shock.

CAUTION

Do not leave this stage in places subject to extremely high temperatures or low temperatures. This may cause an electric shock.

- Operating temperature: +10 to +35 °C
 - Storage/Operating altitude: 1000 m
 - Storage/Operating humidity: 85%
 - Storage temperature: -10 to +40 °C (in its original packaging)
-

**CAUTION**

Do not move this stage if its motor power is on.

Make sure that the cable to the electronics is disconnected before moving the stage. Failure to do so may damage the cable and cause an electrical shock.

CAUTION

Be careful that the stage is not bumped when it is being carried. This may cause it to malfunction.

CAUTION

When handling this stage, always unplug the equipment from the power source for safety.

CAUTION

When the carriage is in its end-of-run position, it is strongly recommended not to go beyond this point as this may damage the stage mechanism.

CAUTION

Contact your Newport service facility to request cleaning and specification control every year.

High-Performance Long-Travel Linear Motor Stages

IMS-LM-S Series

1.0 Introduction

This manual provides operating instructions for the IMS-LM-S stage that you have purchased.

Inside this manual you will find useful information and technical references. It is recommended the user download all support documentation from the IMS-LM-S page of the Newport website to have as reference.

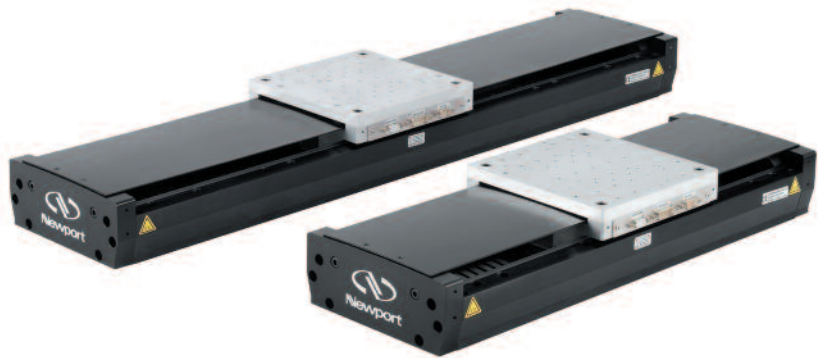

IMS600LM-S & IMS300LM-S Stages.

RECOMMENDATION

We recommend you read carefully the chapters 4.0 and 6.0 for the connection to an electronics, before using an IMS-LM-S stage.

2.0 Description

The IMS-LM-S series of linear motor stages are designed for self-supporting applications with travel ranges from 300 mm to 1200 mm. The stages feature a robust design with high performance at low cost, making them cost-effective solutions for precision industrial applications such as semiconductor wafer inspection, microelectronics test and assembly, pick and place, DNA sequencing, or laser machining. The IMS-LM-S-SA version with, 4-point mounting, is ideal for delay lines and other applications with non-flat mounting surfaces.

The IMS-LM-S series utilizes an FEM optimized extruded aluminum body that is extremely stiff and minimizes bending caused by different thermal expansion coefficients of the aluminum body and steel rails.

Unlike-screw driven stages, the IMS-LM-S employs a center-driven linear motor. This linear motor is absolutely noise-free and has the advantage of higher speed, acceleration and system responsiveness without wear on motor brushes or drive screws. Due to the fully integrated linear motor, the IMS-LM-S is more than 100 mm shorter in length than a comparable screw driven stage. Thus, the IMS-LM-S is the optimum solution for space constrained applications that require high-throughput, high reliability, and ultra-quiet operation.

The IMS-LM-S uses a high efficiency 3-phase synchronous ironcore linear motor. While ironcore linear motors are often criticized for their cogging and high attractive forces, their efficiency is almost twice the efficiency of ironless linear motors. This results in higher acceleration capability and significantly less heat generation, which often limits performance of rapid point-to-point positioning.

Recirculating ball bearing slides with caged balls provide excellent payload capacity and long life. The ball separators in the recirculating elements ensure superior smooth movement, lower noise, and longer service life compared to uncaged ball bearing slides.

Precision position feedback is supplied by a highly repeatable linear scale mounted inside the stage. The encoder signals are interpolated by Newport's motion controllers with outstanding 20 nm Minimum Incremental Motion, repeatability, and stability. Absolute home position and limit signals are incorporated to improve repeatability and reliability, while simplifying the design with less electronics and mechanical parts.

2.1 Design Details

Base Material	Extruded Aluminum
Bearings	Recirculating bearings with caged balls
Drive System	3-phase synchronous ironcore linear motor (no Hall effect sensors)
Motor Initialization	Has to be done by the controller (without using Hall effect sensors)
Feedback	Linear steel scale, 20 μ m signal period, 1 Vpp
Limit Switches	Optical
Home Switch	Optical, on encoder's fiducial track, located at center of travel
ESP Compatibility	Yes
MTBF	20,000 hours

3.0 Characteristics

3.1 Definitions

Specifications of our products are established in reference to ISO 230 standard part II “Determination of accuracy and repeatability of positioning numerically controlled axes”.

This standard gives the definition of position uncertainty which depends on the 3 following parameters:

Absolute Accuracy

Difference between ideal position and real position.

Accuracy

Difference between ideal position and real position after the compensation of linear errors.

Linear errors include: cosine errors, inaccuracy of screw or linear scale pitch, angular deviation at the measuring point (Abbe error) and thermal expansion effects. All Newport motion electronics can compensate for linear errors.

The relation between absolute accuracy and on-axis accuracy is as follows:

$$\text{Absolute Accuracy} = \text{Accuracy} + \text{Correction Factor} \times \text{Travel}$$

Repeatability

Ability of a system to achieve a commanded position over many attempts.

Reversal Value (Hysteresis)

Difference between actual position values obtained for a given target position when approached from opposite directions.

Minimum Incremental Motion (MIM or Sensitivity)

The smallest increment of motion a device is capable of delivering consistently and reliably.

Resolution

The smallest increment that a motion device can theoretically move and/or detect. Resolution is not achievable, whereas MIM, is the real output of a motion system.

Yaw, Pitch

Rotation of carriage around the Z axis (Yaw) or Y axis (Pitch), when it moves.

The testing of accuracy, repeatability, and reversal error are made systematically with test equipment in controlled environment (20^{±1} °C).

A linear cycle with 21 data points on the travel and 4 cycles in each direction gives a total of 168 points.

Guaranteed and Typical Specifications

Guaranteed maximum performance values are verified per Newport's A167 metrology test procedure. For more information, please consult the metrology tutorial section in the Newport catalog or at www.newport.com

3.2 Mechanical Specifications

	Travel Range (mm)	IMS-LM-S	IMS-LM-SA-S
Travel Range (mm)		300, 400, 500, 600, 800, 1000 and 1200	800, 1000 and 1200
Minimum Incremental Motion (nm)		20	
Bidirectional Repeatability, Typical (Guaranteed) ⁽¹⁾ (µm)	300 & 400:- 500 & 600: 800: 1000: 1200:	±0.08 (±0.25) ±0.09 (±0.25) ±0.10 (± 0.50) ±0.12 (± 0.50) ±0.13 (± 0.50)	– – ±0.10 (± 0.50) ±0.12 (± 0.50) ±0.13 (± 0.50)
Accuracy, Typical (Guaranteed) ⁽¹⁾ (µm)	300: 400: 500: 600: 800 & 1000: 1200:	±1.7 (±4.5) ±2.0 (±4.5) ±2.5 (±5.5) ±3.0 (±7.5) ±4.0 (±9.0) ±5.0 (±9.0)	– – – – ±4.0 (±9.0) ±5.0 (±15)
Maximum Speed (No Load) ⁽²⁾ (mm/s)		1000 (refer to chart below)	
Maximum Acceleration (No Load) ⁽²⁾ (m/s ²)		40	
Moving mass (kg)		Carriage: 3.5 + Interface:1 = 4.5	
Drag force (torque)		Approx. 15 N	
Pitch, Typical (Guaranteed) ⁽¹⁾⁽³⁾ (µrad)	300 to 500: 600: 800: 1000: 1200:	±37 (±75) ±50 (±125) ±100 (±200) ±112 (±225) ±125 (±250)	– – ±100 (±200) ±112 (±225) ±125 (±250)
Yaw, Typical (Guaranteed) ⁽¹⁾⁽³⁾ (µrad)	300: 400 & 500: 600: 800 to 1200:	±25 (±50) ±25 (±75) ±30 (±75) ±40 (±150)	– – – ±40 (±150)



¹⁾ For the definition of Typical and Guaranteed specifications see "Motion Basics Terminology & Standards" Tutorial at www.newport.com

²⁾ Speed depends on the driver.

³⁾ To obtain arcsec units, divide µrad value by 4.8.

NOTE

The following specifications are controller/driver dependent:

- Minimum Incremental Motion (MIM)
- Maximum Speed
- Maximum Acceleration

Refer to the IMS-LM-S Series page on www.newport.com for specifications achievable with specific Newport controller/driver combination.



CAUTION

To reach stated specifications, the stages must be fixed on a plane surface with a flatness of 5 µm.

3.3 Hard Stop: Speed Limitation Versus Load

IMS-LM-S stage uses electrical end-of-run and elastomer hard stops to stop the carriage as smoothly as possible past the end-of-runs. The overtravel allowed by the hard stops is 8 mm.

When the stage is used with Newport controllers, the factory settings of the "software limits" prohibit any commanded motion beyond this travel range.

Nevertheless, for safety reasons, follow the recommendations above to minimize risk of mechanical damage, in case of failure or incorrect adjustment of parameters.

The maximum speed of the stage must be limited so that the hard stops will always stop the carriage in 8 mm or less, to avoid any shock between the carriage and stage body.

The graph at left, provides stage speed as a function of applied load. This curve defines allowed operating conditions to stop within the 8 mm over-travel allowed by the hard stops. To stop within this distance, the user must maintain speed and load within this tolerance. This graph assumes correct wiring of the electrical end of runs will cut motor power before contact with the hard stop.

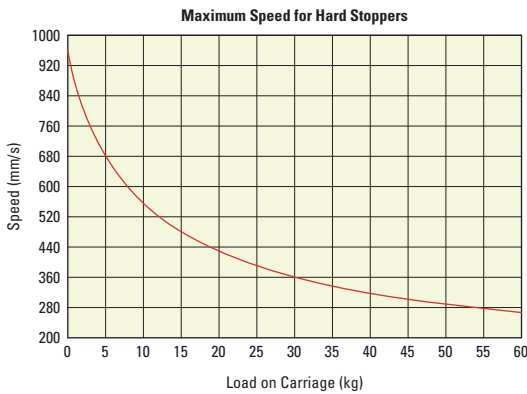

3.4 Load Characteristics and Stiffness

Normal Load Capacity (Cz)

Maximum load a stage can move while maintaining specifications.

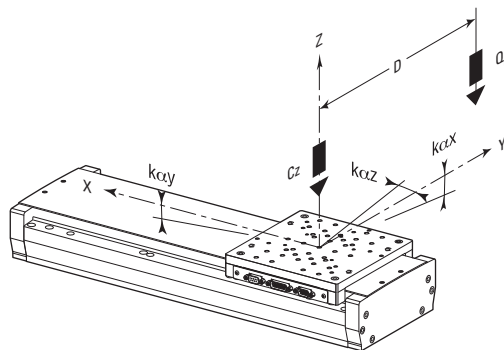

	IMS-LM-S	IMS-LM-SA-S
Cz, Normal center load capacity on bearings	600 N	100 N
kαx, Angular stiffness (Roll)	1 μrad/Nm	2 μrad/Nm
kαy, Angular stiffness (Pitch)	0.2 μrad/Nm	2 μrad/Nm
kαz, Angular stiffness (Yaw)	1 μrad/Nm	1 μrad/Nm
Q, Off-center load	$Q \leq Cz/(1 + D/90)$	
D, Cantilever distance in mm		

3.5 Stage Weights

The stage weights indicated below do not include the cables.

	Weight [lb (kg)]	
	-LM	-LM-SA
IMS300-S	37.5 (17)	—
IMS400-S	41.9 (19)	—
IMS500-S	46.3 (21)	—
IMS600-S	50.7 (23)	—
IMS800-S	52.9 (24)	52.9 (24)
IMS1000-S	61.7 (28)	61.7 (28)
IMS1200-S	70.5 (32)	70.5 (32)

4.0

Drive and Motor

4.1 Motor characteristics

IMS-LM-S stages are equipped with a 3-phase synchronous ironcore linear motor and a linear steel scale.

Magnet Pitch (Commutation period)	24 mm
Motor constant	180 N ² /W
Force sensitivity	38.9 N/Arms
Back-emf constant	31.7 V/m/s
Motor resistance	5.6 Ω
Motor inductance	36 mH
Thermal resistance	0.7 °C/W
Max. speed @ Max. voltage	8 m/s @ 560 V
Peak current	6 Arms
Peak force	210 N
Max. rms current	3.1 Arms
Max. rms force	120 N
Temperature Sensor	PTC, 1 kΩ



CAUTION

High RMS current will generate motor heating which will degrade characteristics of the stage, such as repeatability, accuracy, etc...

4.2 Command Signals

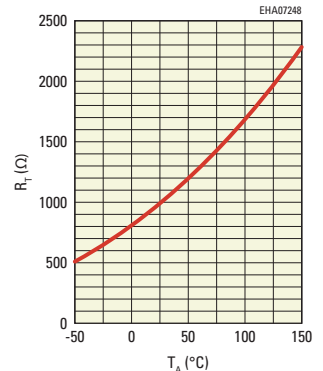
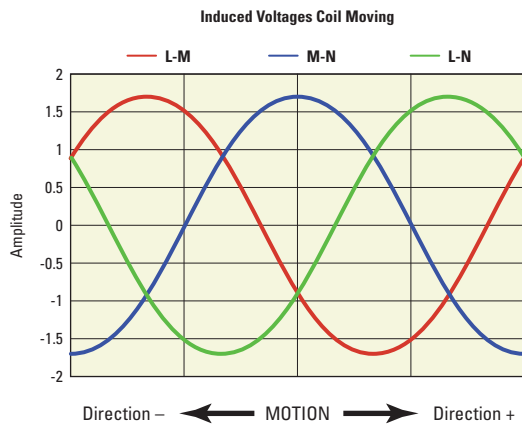
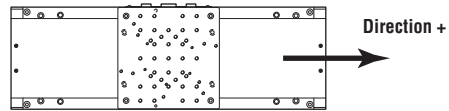

Positive Temperature Coefficient Thermistor, resistance as a function of temperature. Motor heating is typically restricted to 20 °C with Newport Controllers.

NOTE

The values above indicate induced voltages between coils. A positive value for L-M would indicate a higher voltage on L relative to M.

4.3 Sensor Positions

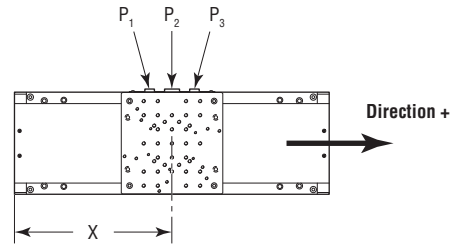

X Values (mm)	- Hard Limit	- End-of-Run Limit	Mech. Zero	Home Position	+ End-of-Run Limit	+ Hard Limit
IMS300LM-S	126.5 ⁰ / _{-.8}	128 ^{+0.5}	279 ^{+0.25}	279.5 ^{+0.25}	431 ^{+0.5}	732.5 ⁺⁸ / ₀
IMS400LM-S	126.5 ⁰ / _{-.8}	128 ^{+0.5}	329 ^{+0.25}	329.5 ^{+0.25}	481 ^{+0.5}	732.5 ⁺⁸ / ₀
IMS500LM-S	126.5 ⁰ / _{-.8}	128 ^{+0.5}	379 ^{+0.25}	379.5 ^{+0.25}	531 ^{+0.5}	732.5 ⁺⁸ / ₀
IMS600LM-S	126.5 ⁰ / _{-.8}	128 ^{+0.5}	429 ^{+0.25}	429.5 ^{+0.25}	581 ^{+0.5}	732.5 ⁺⁸ / ₀
IMS800LM(-SA)-S	144.5 ⁰ / _{-.8}	160 ^{+0.5}	564.5 ^{+0.25}	565 ^{+0.25}	970 ^{+0.5}	980.5 ⁺⁸ / ₀
IMS1000LM(-SA)-S	144.5 ⁰ / _{-.8}	160 ^{+0.5}	664.5 ^{+0.25}	665 ^{+0.25}	1170 ^{+0.5}	1180.5 ⁺⁸ / ₀
IMS1200LM(-SA)-S	144.5 ⁰ / _{-.8}	160 ^{+0.5}	764.5 ^{+0.25}	765 ^{+0.25}	1370 ^{+0.5}	1380.5 ⁺⁸ / ₀

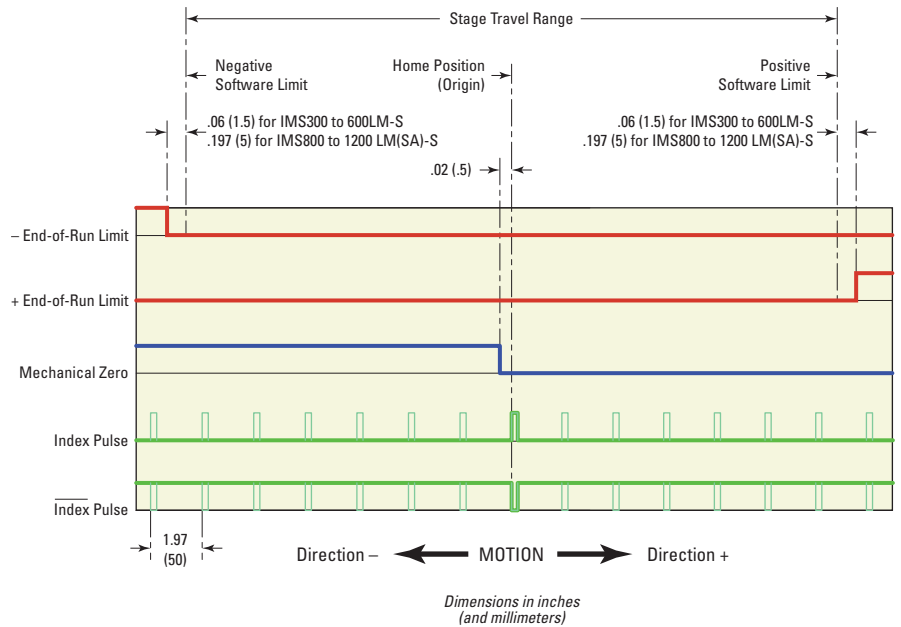

4.4 Position Feedback Signals

Signal description / Voltage / wiring	Heidenhain standard 1 Vpp
Reference mark position	see drawing "Sensor Positions"
Resolution	Scale pitch 20 μm
Maximum speed	8 m/s

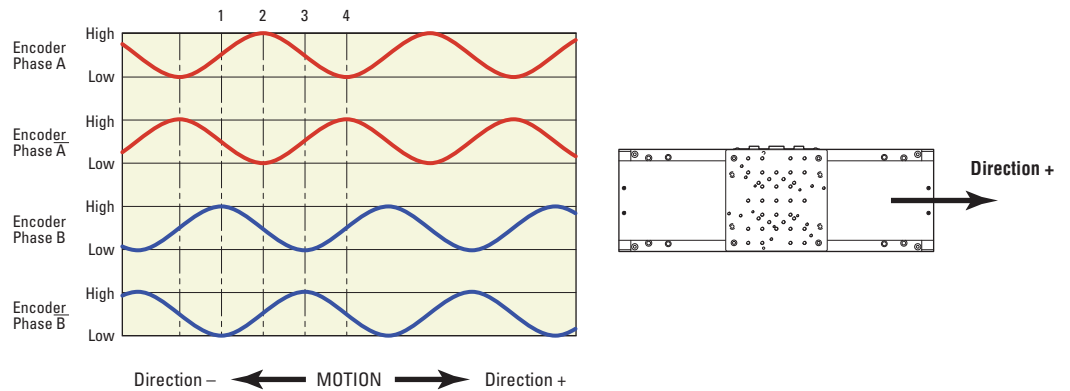

4.5 Pinouts

The pinout diagrams for IMS-LM-S stage connectors are shown below.

4.5.1 Motor Connector (P1)

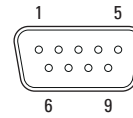

SUB-D9M	
1	Phase L Motor
2	Phase L Motor
3	Phase M Motor
4	Phase M Motor
5	Thermistor 1
6	Phase N Motor
7	Phase N Motor
8	Ground
9	Thermistor 2

- Max. voltage: 96 V
- Max. rms Current: 3.1 A

WARNING



GROUNDING: The stage's protective ground is located on pin #8 of the motor power connector.

If you are using grounds other than those provided by Newport, you must connect pin #8 to a ground connection.

4.5.2 Encoder Connector (P2)

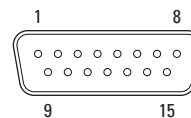

SUB-D15M	
1	Encoder Phase B
2	Ground
3	Encoder Phase A
4	+5 V
5	N.C.
6	N.C.
7	Index Pulse /I
8	N.C.
9	Encoder Phase /B
10	N.C.
11	Encoder Phase /A
12	N.C.
13	N.C.
14	Index Pulse I
15	N.C.

4.5.3 End-of-Runs & Thermistor Connector (P3)

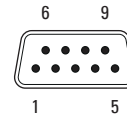

SUB-D9F	
1	+ End-of-Run
2	- End-of-Run
3	Mechanical Zero
4	N.C.
5	+5 V
6	Thermistor 1
7	Ground
8	Thermistor 2
9	Ground

4.6 Cables

The IMS-LM-S stages are supplied without cables.

The appropriate cable kit must be ordered separately, in accordance with the XPS controller configuration used. Please refer to our website for ordering information.



WARNING

The IMS-LM-S Series stages operate only with 5-meter max. cables.



WARNING

Cables of the kits are shielded correctly. For a correct operation, make sure to lock connectors (ground continuity provided by the cable).



WARNING

Keep these cables at a safe distance from other electrical cables in your environment to avoid potential cross talk.

5.0 Stage Installation

5.1 Unpacking

The IMS-LM-S stage will be delivered to your site in packaging designed for safe transport. Attached to the body of the stage are handles for safe removal from packaging. It is recommended to carefully lift the stage from packaging using these handles.



The stage will come delivered with a control report that indicates performance of your stage within guaranteed specification. These measurements were taken in a controlled environment under flat mounting conditions.

5.2 Mounting Conditions

IMS-LM-S-SA stages feature a four-point mounting which is ideal for operation on non-flat surfaces. However it is recommended for all IMS-LM-S and IMS-LM-S-SA stages that the following mounting conditions be adhered to for best performance.

Installation Considerations

Mounting surface flatness	5 μm
Payload surface flatness	10 μm
Mounting Screw torque	7 Nm

6.0 Connection to Newport Controllers

NOTE

Visit www.newport.com for compatible Newport controllers.

6.1 Operating with Newport Controllers/Drives

Newport provides detailed documentation for connecting and configuring IMS-LM-S stages with compatible Newport controllers/drives. Newport controllers proprietary plug-and-play ESP technology will automatically load configuration parameters for the stage based on best factory settings in a no load condition. These configurations can be adjusted for optimal operation under various applications and load conditions. Refer to documentation available on the IMS-LM-S Series Page for additional information.

6.2 Warnings on Controllers

Controllers are intended for use by qualified personnel who recognize shock hazards and are familiar with safety precautions required to avoid possible injury. Read the controller user's manual carefully before operating the instrument and pay attention to all written warnings and cautions.

Specifications listed in this guide are based on operation with Newport Control and Drive Electronics. The Newport controllers with ESP technology are delivered with a configuration file that has been developed at the factory for operation in a no-load condition for immediate plug-and-play operation.

WARNING

Disconnect the power plug under the following circumstances:

- If the power cord or any attached cables are frayed or damaged in any way.
- If the power plug is damaged in any way.
- If the unit is exposed to rain, excessive moisture, or liquids are spilled on the unit.
- If the unit has been dropped or the case is damaged.
- If you suspect service or repair is required.
- Whenever you clean the electronics unit.



CAUTION

To protect the unit from damage, be sure to:

- Keep all air vents free of dirt and dust.
 - Keep all liquids away from the unit.
 - Do not expose the unit to excessive moisture (85% humidity).
 - Read this manual before using the unit for the first time.
-

WARNING

All attachment plug receptacles in the vicinity of this unit are to be of the grounding type and properly polarized.

Contact your electrician to check your receptacles.

WARNING



This product is equipped with a 3-wire grounding type plug.

Any interruption of the grounding connection can create an electric shock hazard.

If you are unable to insert the plug into your wall plug receptacle, contact your electrician to perform the necessary alterations to ensure that the green (green-yellow) wire is attached to earth ground.

WARNING

This product operates with voltages that can be lethal.

Pushing objects of any kind into cabinet slots or holes, or spilling any liquid on the product, may touch hazardous voltage points or short out parts.

6.3 Connection

There is a label on every stage indicating its part and serial numbers.



WARNING

Always turn the controller's power OFF before connecting to a stage.

NOTE



These stages are ESP compatible. Enhanced System Performance is Newport's exclusive technology that enables Newport ESP motion controllers to recognize the connected Newport ESP stage and upload the stage parameters. This ensures that the user can operate the motion system quickly and safely.

6.4 Wiring

The IMS-LM-S stages are supplied without cables (see chapter 4.6: "Cables").

7.0 Connection to Non-Newport Controllers

7.1 Connections

WARNING

Newport is not responsible for malfunction or damage of IMS-LM-S stages when used with non-Newport controllers.

WARNING

Newport guarantees “CE” compliance of IMS-LM-S stages only if used with the appropriate Newport cable kit and a XPS series controller.

It is the customer’s responsibility to modify the cable and take care of sensor signal connections, when using the stage with non-Newport controllers.

WARNING

- Maximum peak voltage: 100 V_{peak}
 - Maximum rms current: 3.1 Arms.
-

8.0 Dimensions

8.1 (M-)IMS-LM-S Stages

MODEL SHOWN: IMS300LM-S
DIMENSIONS IN INCHES (AND MILLIMETERS)

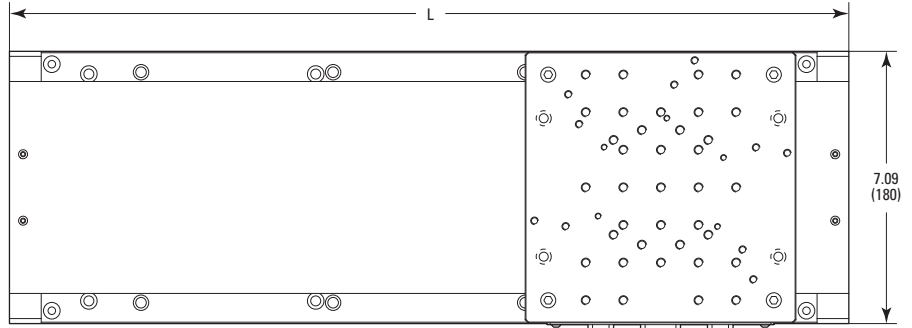

SIDE VIEW
IMS300LM-S TO IMS600LM-S

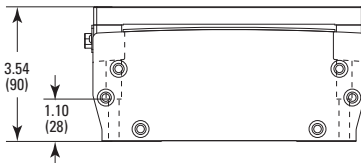

SIDE VIEW
IMS800LM(-SA)-S TO IMS1200LM(-SA)-S

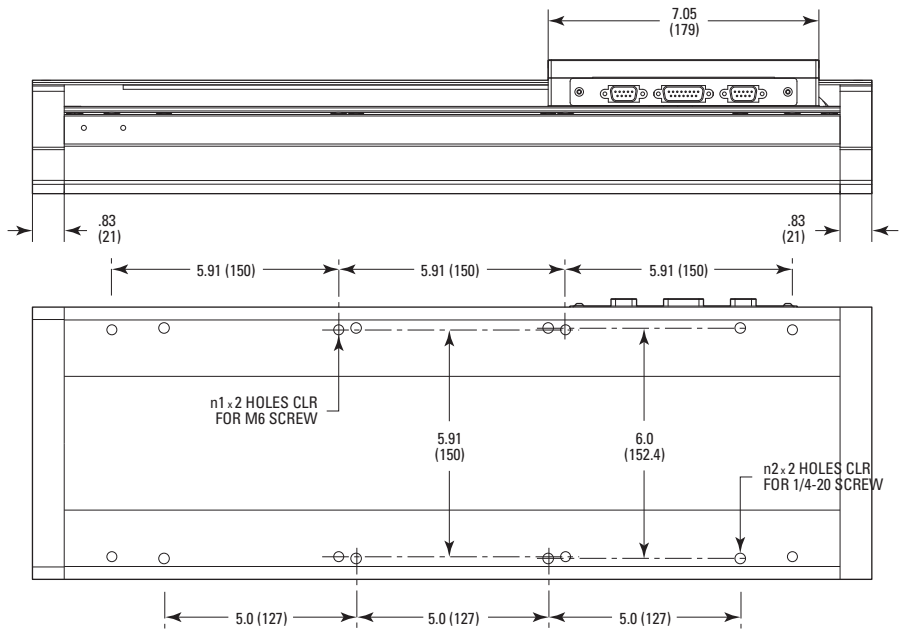
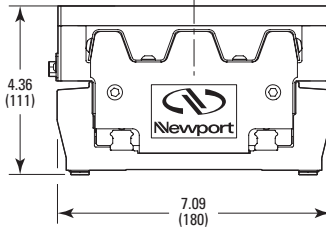

MODEL (METRIC)	n1	n2	TRAVEL	L
(M-)IMS300LM-S	4	4	11.81 (300)	21.85 (555)
(M-)IMS400LM-S	4	4	15.75 (400)	25.79 (655)
(M-)IMS500LM-S	4	6	19.69 (500)	29.72 (755)
(M-)IMS600LM-S	6	6	23.62 (600)	33.66 (855)
(M-)IMS800LM-S	6	-	31.49 (800)	44.48 (1130)
(M-)IMS1000LM-S	7	-	39.36 (1000)	52.35 (1330)
(M-)IMS1200LM-S	8	-	47.23 (1200)	60.22 (1530)
(M-)IMS800LM-SA-S	4 HOLES ON 26 x 6 (600 x 150)	-	31.49 (800)	44.48 (1130)
(M-)IMS1000LM-SA-S	4 HOLES ON 28 x 6 (750 x 150)	-	39.36 (1000)	52.35 (1330)
(M-)IMS1200LM-SA-S	4 HOLES ON 34 x 6 (900 x 150)	-	47.23 (1200)	60.22 (1530)

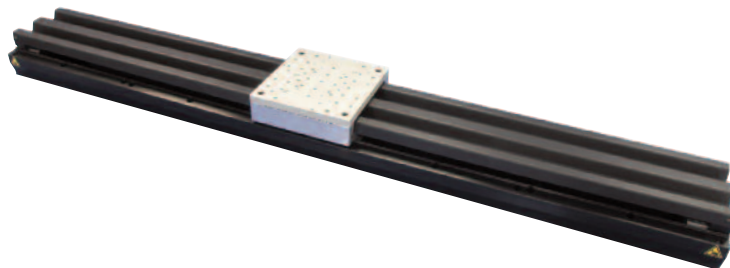

IMS800LM-SA-S stage.

8.2 Top Plate Interfaces

IMS-LM-S Stages Top Plate Interface

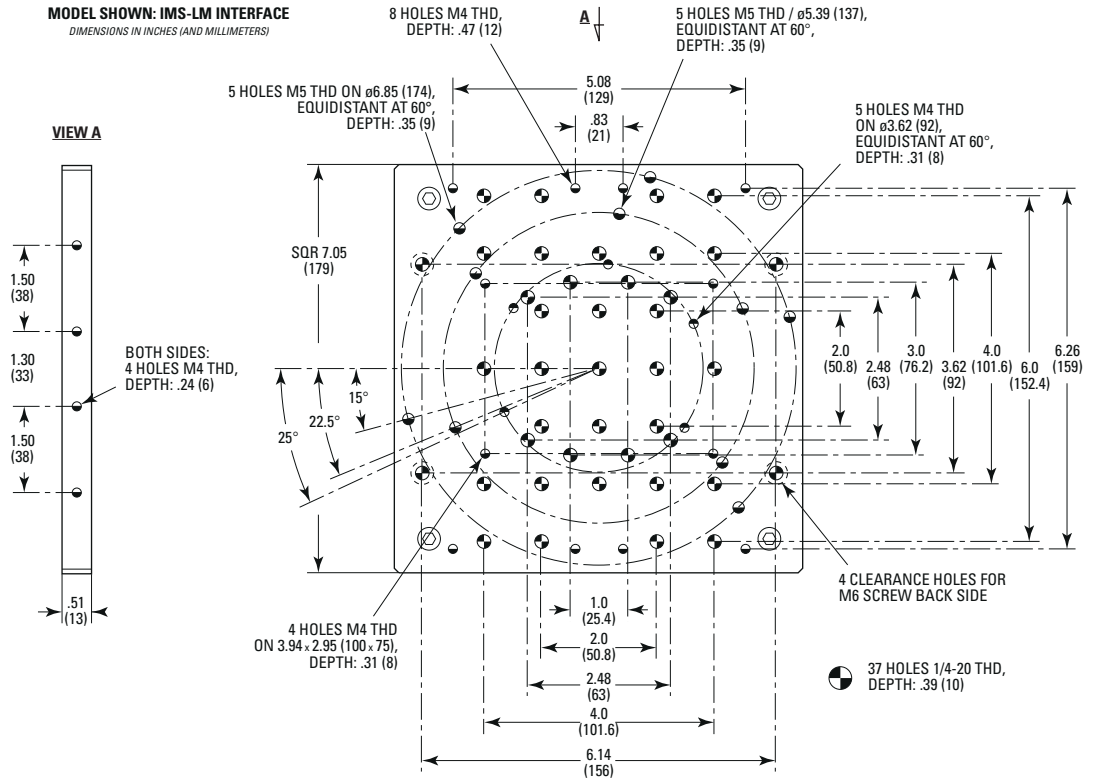

M-IMS-LM-S Stages Top Plate Interface

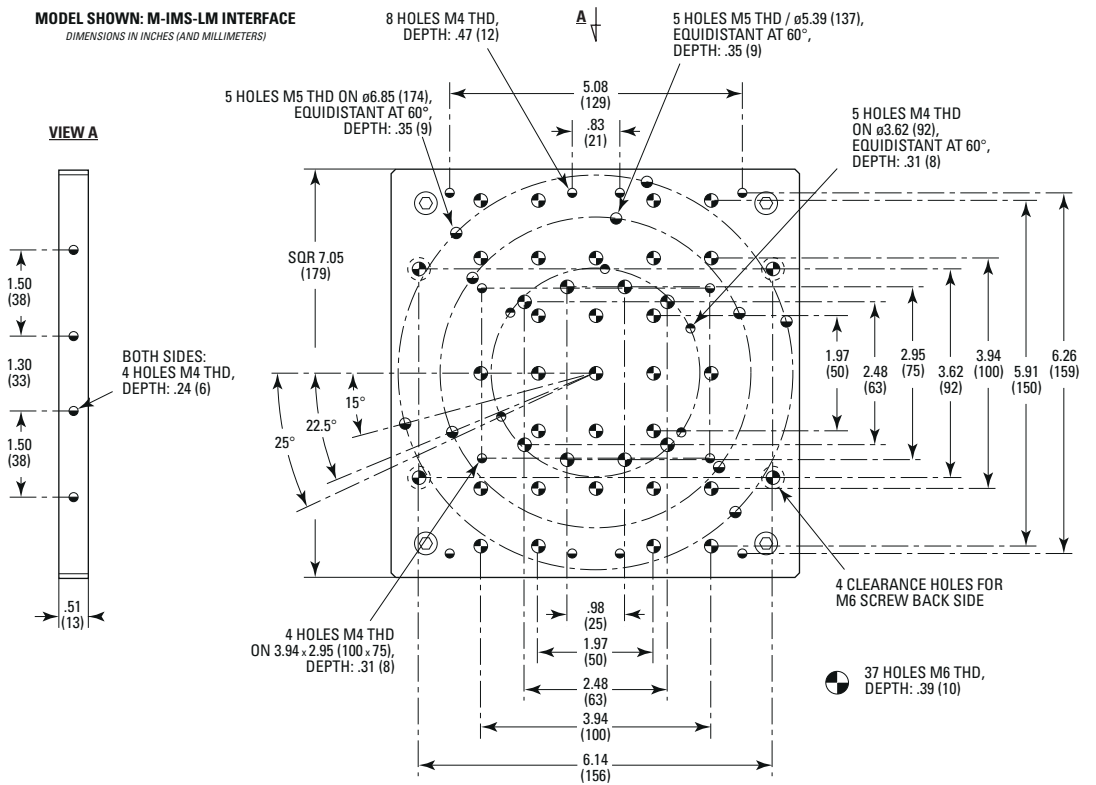

8.3 Cable Chains

NOTE

IMSLMC for stages with a travel of 300 to 600 mm
 IMSLMC2 for stages with a travel of 800 to 1200 mm

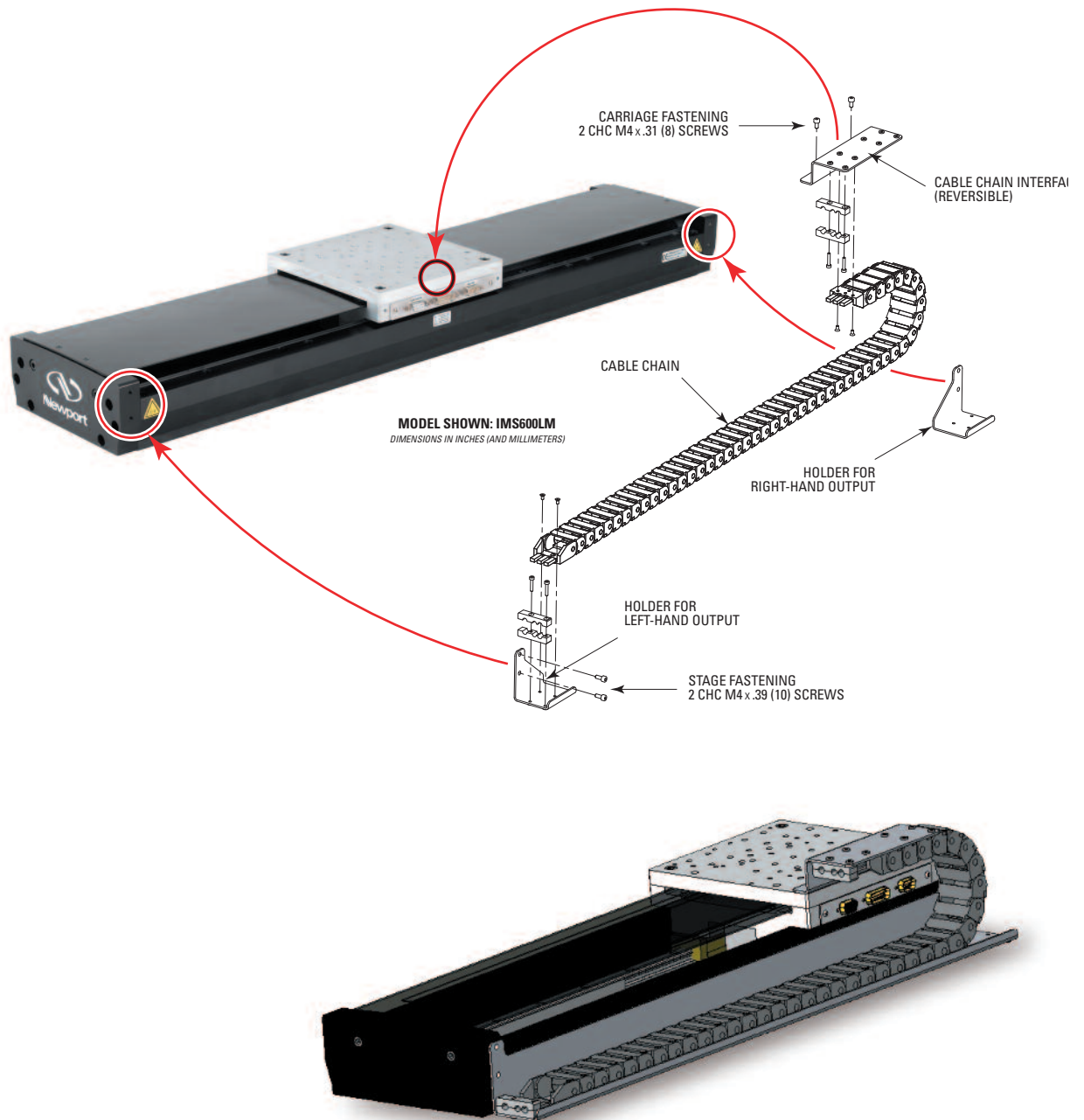

IMSLMC cable chain for routing cables to the stationary base. For cable management of XY assemblies, please call Newport.

9.0 Maintenance

RECOMMENDATION

Please contact Technical Sales Support team for recommendations on application specific maintenance.

9.1 Maintenance

The IMS-LM-S stage requires no particular maintenance. Nevertheless, this is a precision mechanical device that must be kept and operated with caution.

PRECAUTIONS

The IMS-LM-S stage must be used or stocked in a clean environment, without dust, humidity, solvents or other substances.

RECOMMENDATION

It is recommended to return the stage to Newport for re-lubrication after 2000 hours of use.

If the IMS-LM-S stage is mounted on a workstation and cannot be easily removed, please contact Newport's After Sales Service for further instructions.

9.2 Repair

CAUTION



Never attempt to disassemble a component of the stage that has not been covered in this manual.

To disassemble a non specified component can cause a malfunction of the stage.

If you observe a malfunction in your stage, please contact us immediately to arrange for a repair.



CAUTION

Any attempt to disassemble or repair a stage without prior authorization will void your warranty.

9.3 Calibration



CAUTION

It is recommended to return your IMS-LM-S stage to Newport once a year for recalibration to its original specifications.



Visit Newport Online at:
www.newport.com

North America & Asia

Newport Corporation
1791 Deere Ave.
Irvine, CA 92606, USA

Sales

Tel.: (800) 222-6440
e-mail: sales@newport.com

Technical Support

Tel.: (800) 222-6440
e-mail: tech@newport.com

Service, RMAs & Returns

Tel.: (800) 222-6440
e-mail: service@newport.com

Europe

MICRO-CONTROLE Spectra-Physics S.A.S
9, rue du Bois Sauvage
91055 Évry CEDEX
France

Sales & Technical Support

Tel.: +33 (0)1.60.91.68.68
e-mail: france@newport.com

Service & Returns

Tel.: +33 (0)2.38.40.51.55

