

Model 6100

Laser Diode and Temperature Controller



User's Manual



Newport®
Experience | Solutions

EU Declaration of Conformity

We declare that the accompanying product, identified with the **CE** mark, complies with requirements of the Electromagnetic Compatibility Directive, 2004/108/EC and the Low Voltage Directive 2006/95/EC.

Model Number: 6100

Year **CE mark affixed: 2013**

Type of Equipment: Electrical equipment for measurement, control and laboratory use in industrial locations.

Manufacturer: Newport Corporation

1791 Deere Avenue
Irvine, CA 92606

Standards Applied:

Compliance was demonstrated to the following standards to the extent applicable:

BS EN61326-1: 2006 “Electrical equipment for measurement, control and laboratory use – EMC requirements”.

BS EN 61010-1:2010 “Safety requirements for electrical equipment for measurement, control and laboratory use”.



Todd McFarland
Senior Electrical Engineer
31950 E. Frontage Rd
Bozeman, MT, USA

Warranty

Newport Corporation warrants that this product will be free from defects in material and workmanship and will comply with Newport's published specifications at the time of sale for a period of one year from date of shipment. If found to be defective during the warranty period, the product will either be repaired or replaced at Newport's option.

To exercise this warranty, write or call your local Newport office or representative, or contact Newport headquarters in Irvine, California. You will be given prompt assistance and return instructions. Send the product, freight prepaid, to the indicated service facility. Repairs will be made and the instrument returned freight prepaid. Repaired products are warranted for the remainder of the original warranty period or 90 days, whichever first occurs.

Limitation of Warranty

The above warranties do not apply to products which have been repaired or modified without Newport's written approval, or products subjected to unusual physical, thermal or electrical stress, improper installation, misuse, abuse, accident or negligence in use, storage, transportation or handling. This warranty also does not apply to fuses, batteries, or damage from battery leakage.

THIS WARRANTY IS IN LIEU OF ALL OTHER WARRANTIES, EXPRESSED OR IMPLIED, INCLUDING ANY IMPLIED WARRANTY OF MERCHANTABILITY OR FITNESS FOR A PARTICULAR USE. NEWPORT CORPORATION SHALL NOT BE LIABLE FOR ANY INDIRECT, SPECIAL, OR CONSEQUENTIAL DAMAGES RESULTING FROM THE PURCHASE OR USE OF ITS PRODUCTS.

First printing 2009

© 2018 by Newport Corporation, Irvine, CA. All rights reserved. No part of this manual may be reproduced or copied without the prior written approval of Newport Corporation.

This manual has been provided for information only and product specifications are subject to change without notice. Any change will be reflected in future printings.

Newport Corporation
1791 Deere Avenue
Irvine, CA, 92606
USA

Part No. 90032866 REV D June 2018

Confidentiality & Proprietary Rights

Reservation of Title:

The Newport programs and all materials furnished or produced in connection with them ("Related Materials") contain trade secrets of Newport and are for use only in the manner expressly permitted. Newport claims and reserves all rights and benefits afforded under law in the Programs provided by Newport Corporation.

Newport shall retain full ownership of Intellectual Property Rights in and to all development, process, align or assembly technologies developed and other derivative work that may be developed by Newport. Customer shall not challenge, or cause any third party to challenge the rights of Newport.

Preservation of Secrecy and Confidentiality and Restrictions to Access:

Customer shall protect the Newport Programs and Related Materials as trade secrets of Newport, and shall devote its best efforts to ensure that all its personnel protect the Newport Programs as trade secrets of Newport Corporation. Customer shall not at any time disclose Newport's trade secrets to any other person, firm, organization, or employee that does not need (consistent with Customer's right of use hereunder) to obtain access to the Newport Programs and Related Materials. These restrictions shall not apply to information (1) generally known to the public or obtainable from public sources; (2) readily apparent from the keyboard operations, visual display, or output reports of the Programs; 3) previously in the possession of Customer or subsequently developed or acquired without reliance on the Newport Programs; or (4) approved by Newport for release without restriction.

Trademarks

The Newport logo is a registered trademark of Newport Corporation in Austria, Barbados, Benelux, Canada, the People's Republic of China, Denmark, France, Germany, Great Britain, Ireland, Japan, the Republic of Korea, Spain, Sweden, and the United States. Newport is a registered trademark of Newport Corporation in Austria, Barbados, Benelux, the People's Republic of China, Denmark, France, Germany, Ireland, Japan, the Republic of Korea, Spain, and Sweden.

Service Information

This section contains information regarding factory service for the source. The user should not attempt any maintenance or service of the system or optional equipment beyond the procedures outlined in this manual. Any problem that cannot be resolved should be referred to Newport Corporation.

Technical Support Contacts

North America & Asia

Newport Corporation Service Dept.
1791 Deere Ave. Irvine, CA 92606
Telephone: (949) 253-1694
Telephone: (800) 222-6440 x31694

Europe

Newport/MICRO-CONTROLE S.A.
Zone Industrielle
45340 Beaune la Rolande, FRANCE
Telephone: (33) 02 38 40 51 56

Asia

Newport Opto-Electronics Technologies

中国 上海市 爱都路 253号 第3号楼 3层
C部位, 邮编 200131

253 Aidu Road, Bld #3, Flr 3, Sec C,
Shanghai 200131, China

Telephone: +86-21-5046 2300

Fax: +86-21-5046 2323

Newport Corporation Calling Procedure

If there are any defects in material or workmanship or a failure to meet specifications, promptly notify Newport's Returns Department by calling 1-800-222-6440 or by visiting our website at www.newport.com/returns within the warranty period to obtain a **Return Material Authorization Number (RMA#)**. Return the product to Newport Corporation, freight prepaid, clearly marked with the RMA# and we will either repair or replace it at our discretion. Newport is not responsible for damage occurring in transit and is not obligated to accept products returned without an RMA#.

E-mail: rma.service@newport.com

When calling Newport Corporation, please provide the customer care representative with the following information:

- Your Contact Information
- Serial number or original order number
- Description of problem (i.e., hardware or software)

To help our Technical Support Representatives diagnose your problem, please note the following conditions:

- Is the system used for manufacturing or research and development?
- What was the state of the system right before the problem?
- Have you seen this problem before? If so, how often?
- Can the system continue to operate with this problem? Or is the system non-operational?
- Can you identify anything that was different before this problem occurred?

Table of Contents

EU Declaration of Conformity.....	iii
Warranty.....	iv
Technical Support Contacts	vi
Table of Contents	vii
List of Figures	xi
List of Tables	xii

1 Safety Precautions 13

1.1 Definitions and Symbols	13
1.1.1 General Warning or Caution	13
1.1.2 Electric Shock.....	13
1.1.3 European Union CE Mark	14
1.1.4 Alternating voltage symbol	14
1.1.5 On	14
1.1.6 Off.....	14
1.1.7 Fuses	15
1.1.8 USB	15
1.1.9 Frame or Chassis	15
1.1.10 Waste Electrical and Electronic Equipment (WEEE)	15
1.1.11 Control of Hazardous Substances.....	16
1.2 Warnings and Cautions.....	16
1.2.1 General Warnings.....	16
1.2.2 General Cautions	17
1.2.3 Summary of Warnings and Cautions.....	18
1.3 Location of Labels and Warnings.....	19
1.3.1 Rear Panel.....	19

2 General Information 21

2.1 Introduction	21
2.1.1 Laser Diode Driver Subsystem.....	21
2.1.2 Temperature Controller Subsystem.....	22
2.1.3 Instrument Features	22
2.2 Input Power	23
2.3 Available Options and Accessories	23
2.4 Specifications	24
2.4.1 Laser Diode Driver	24
2.4.2 Temperature Controller	27

2.4.3	General Subsystem	29
3	Getting Started	31
3.1	Unpacking and Handling	31
3.2	Inspection for Damage	31
3.3	Parts List	32
3.4	Choosing and Preparing a Suitable Work Surface	32
3.5	Electrical Requirements	32
3.6	Power Supplies	33
4	System Operation	35
4.1	General Features	35
4.1.1	Laser Diode Driver Features	35
4.1.2	Temperature Controller Features	36
4.2	Safety Features	37
4.2.1	Conditions Which Will Automatically Shut OFF the Laser Diode Output	38
4.2.2	Conditions Which Will Automatically Shut OFF the TEC Output	38
4.2.3	Power Line Surge Protection	38
4.3	Front Panel	39
4.3.1	Key Switch	39
4.3.2	LASER DIODE OUTPUT ON Switch and Indicator	40
4.3.3	LASER DIODE ERROR Indicator LED	40
4.3.4	LASER DIODE LIMIT Indicator LED	40
4.3.5	LASER DIODE Display Section	41
4.3.6	TEC OUTPUT ON Switch and Indicator	41
4.3.7	TEC ERROR Indicator LED	41
4.3.8	TEC LIMIT Indicator LED	42
4.3.9	TEC Status LEDs	42
4.3.10	TEC DISPLAY Section	42
4.4	Menu Section	43
4.4.1	Control Knob	43
4.4.2	Setup / Enter	43
4.4.3	Esc	43
4.4.4	Cursor Arrow Keys	44
4.4.5	Display Elements	44
4.4.6	Menu Selection	44
4.4.7	Title Screen	45
4.4.8	Measurement Screen	45

4.4.9	Setup Screens.....	49
4.5	Rear Panel.....	62
4.5.1	USB Interface.....	63
4.5.2	Chassis GND.....	63
4.5.3	AC Power Cord.....	63
4.5.4	Fuses.....	63
4.5.5	TEC Output Connector.....	64
4.5.6	Laser Diode Output Connector.....	65
4.5.7	I/O Signals Connector.....	66
4.6	Signals I/O.....	67
4.6.1	Fault.....	67
4.6.2	TTL Input.....	67
4.6.3	TTL Output.....	68
4.6.4	LDD Current Monitor Output / Current Monitor Output (Return).....	68
4.6.5	LDD Voltage Monitor Output / Voltage Monitor Output (Return).....	68
4.6.6	LD Cathode Sense / LD Anode Sense.....	68
4.6.7	Analog Input / Analog Input (Return).....	69
4.6.8	Chassis Ground.....	69

5 Computer Interfacing 71

5.1	General Guidelines.....	71
5.2	Computer Interface Terminology.....	71
5.2.1	<...> Delimiting Punctuation.....	71
5.2.2	<CR> Carriage Return.....	71
5.2.3	<LF> Line Feed.....	71
5.2.4	(;) Semicolons.....	71
5.2.5	Command Termination.....	72
5.2.6	Response Termination.....	72
5.3	Controller Operation Mode.....	72
5.4	USB Communication.....	72
5.5	Commands and Queries.....	73

6 Principles of Operation 117

6.1	Introduction.....	117
6.2	TEC and Laser Diode Handling Precautions.....	117
6.3	TEC Controller Operation.....	119
6.3.1	Thermistor and Thermistor Current Selection.....	119
6.3.2	AD590 and LM335.....	123

6.3.3	RTD Sensors.....	127
6.4	Laser Diode Driver Operation	128
6.4.1	Operating Modes	128
6.4.2	Control Modes	129
6.5	TTL Output Modes.....	130
6.5.1	LOW TTL Mode	130
6.5.2	HIGH TTL Mode	130
6.5.3	ENABLE OUTPUT MONITOR TTL Mode	130
6.5.4	PULSE MONITOR TTL Mode.....	131
6.5.5	TTL INPUT MONITOR TTL Mode.....	131
6.6	LIV Characterization	131
7	Tips and Techniques	134
7.1	Introduction	134
7.2	TEC Limits.....	134
7.2.1	Current Limit.....	134
7.2.2	Voltage Limit.....	134
7.2.3	Operating at or Near I_o and V_{te} Limits.....	134
7.3	Grounding a TEC	135
7.4	Laser Limits.....	135
7.4.1	Current Limit.....	135
7.4.2	Voltage Limit.....	136
7.4.3	Operating at or Near I_o and V_{comp} Limits.....	136
7.5	External LD Analog Control	136
7.5.1	Using the LD Analog Control Input as the Set Point....	136
7.5.2	Grounding Considerations when using the LD Analog Control Input	136
7.6	Grounding a Laser Diode	137
7.7	V_f Measurements	137
8	Maintenance and Service	138
8.1	Enclosure Cleaning.....	138
8.2	Obtaining Service	138
8.3	Service Form	139
9	Appendix A – Error Messages	141
9.1	Introduction	141
9.2	Error Description	141

List of Figures

Figure 1	General Warning or Caution Symbol	13
Figure 2	Electrical Shock Symbol	13
Figure 3	CE Mark	14
Figure 4	Alternating Voltage Symbol.....	14
Figure 5	On Symbol.....	14
Figure 6	Off Symbol	14
Figure 7	Fuse Symbol	15
Figure 8	USB Symbol.....	15
Figure 9	Frame or Chassis Terminal Symbol	15
Figure 10	WEEE Directive Symbol.....	15
Figure 11	RoHS Compliant Symbol.....	16
Figure 12	Rear Panel Labels and Warnings.....	19
Figure 13	Front Panel Layout	39
Figure 14	A Sample Setup Screen	44
Figure 15	A Sample Title Screen.....	45
Figure 16	A Sample LDD and TEC Params Measurement Screen	45
Figure 17	A Sample LDD Params Measurement Screen.....	46
Figure 18	A Sample TEC Params Measurement Screen	47
Figure 19	A Sample LIV Params Measurement Screen	48
Figure 20	Model 6100 Menu Structure.....	51
Figure 21	A Sample Set LDD Params Sub-menu.....	51
Figure 22	A Sample Set TEC Params Sub-menu	55
Figure 23	A Sample Set Limits Sub-menu	56
Figure 24	A Sample Set PID Gains Sub-menu.....	57
Figure 25	A Sample Customize PID Gains Sub-menu.....	57
Figure 26	A Sample Sensor Constants Sub-menu	58
Figure 27	A Sample System Parameters Sub-menu	59
Figure 28	A Sample Save Parameters Sub-menu	59
Figure 29	A Sample Save Parameters Sub-menu	60
Figure 30	A Sample Measurement Screen Sub-menu	61
Figure 31	A Sample Measurement Screen when Errors Present	61
Figure 32	A Sample Setup Screen when Errors Present.....	62
Figure 33	Rear Panel.....	63
Figure 34	Thermistor Temperature Range.....	120
Figure 35	Thermistor Resistance versus Temperature	122
Figure 36	AD590 Nonlinearity	124

List of Tables

Table 1	Voltage Selector Switch Settings and Fuse Ratings.....	33
Table 2	Laser Diode Error and Limit LED Status Definition	41
Table 3	TEC Error and Limit LED Status Definition	42
Table 4	TEC Connector Pin-out	64
Table 5	Laser Diode Connector Pin-out	65
Table 6	I/O Signals Connector Pin Assignments	66
Table 7	Command Summary	76
Table 8	HWCONFIG Register	82
Table 9	Thermistor Constants.....	123
Table 10	RTD Constants	127

1 Safety Precautions

1.1 Definitions and Symbols

The following terms and symbols are used in this documentation and also appear on the Model 6100 Laser Diode and Temperature Controller where safety-related issues occur.

1.1.1 General Warning or Caution



Figure 1 General Warning or Caution Symbol

The Exclamation Symbol in the figure above appears on the product and in Warning and Caution tables throughout this document. This symbol designates that documentation needs to be consulted to determine the nature of a potential hazard, and any actions that have to be taken.

1.1.2 Electric Shock



Figure 2 Electrical Shock Symbol

The Electrical Shock Symbol in the figure above appears throughout this manual. This symbol indicates a hazard arising from dangerous voltage. Any mishandling could result in irreparable damage to the equipment, and personal injury or death.

1.1.3 European Union CE Mark



Figure 3 CE Mark

The presence of the CE Mark on Newport Corporation equipment means that this instrument has been designed, tested and certified compliant to all applicable European Union (CE) regulations and recommendations.

1.1.4 Alternating voltage symbol



Figure 4 Alternating Voltage Symbol

This international symbol implies an alternating voltage or current.

1.1.5 On



Figure 5 On Symbol

The symbol in the figure above represents a power switch position on the Model 6100 Laser Diode and Temperature Controller. This symbol represents a Power On condition.

1.1.6 Off



Figure 6 Off Symbol

The symbol in the figure above represents a power switch position on the Model 6100 Laser Diode and Temperature Controller. This symbol represents a Power Off condition.

1.1.7 Fuses

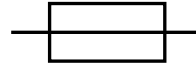

Figure 7 Fuse Symbol

The symbol in the figure above identifies the fuse location on the Model 6100 Laser Diode and Temperature Controller.

1.1.8 USB



Figure 8 USB Symbol

The symbol in the figure above identifies the USB connector location on the Model 6100 Laser Diode and Temperature Controller.

1.1.9 Frame or Chassis



Figure 9 Frame or Chassis Terminal Symbol

The symbol in the figure above appears on the Model 6100 Laser Diode and Temperature Controller. This symbol identifies the frame or chassis terminal

1.1.10 Waste Electrical and Electronic Equipment (WEEE)



Figure 10 WEEE Directive Symbol

This symbol on the product or on its packaging indicates that this product must not be disposed with regular waste. Instead, it is the user responsibility to dispose of waste equipment according to the local laws. The separate collection and recycling of the waste equipment at the time of disposal will

help to conserve natural resources and ensure that it is recycled in a manner that protects human health and the environment. For information about where the user can drop off the waste equipment for recycling, please contact your local Newport Corporation representative.

1.1.11 Control of Hazardous Substances

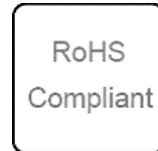

Figure 11 RoHS Compliant Symbol

This label indicates the products comply with the EU Directive 2002/95/EC that restricts the content of six hazardous chemicals.

1.2 Warnings and Cautions

The following are definitions of the Warnings, Cautions and Notes that are used throughout this manual to call your attention to important information regarding your safety, the safety and preservation of your equipment or an important tip.

	WARNING Situation has the potential to cause bodily harm or death.
--	--

	CAUTION Situation has the potential to cause damage to property or equipment.
--	---

NOTE

Additional information the user or operator should consider.

1.2.1 General Warnings

Observe these general warnings when operating or servicing this equipment:

- Heed all warnings on the unit and in the operating instructions.
- Do not use this equipment in or near water.

- This equipment is grounded through the grounding conductor of the power cord.
- Route power cords and other cables so that they are not likely to be damaged.
- Disconnect power before cleaning the equipment. Do not use liquid or aerosol cleaners; use only a damp lint-free cloth.
- Lockout all electrical power sources before servicing the equipment.
- To avoid fire hazard, use only the specified fuse(s) with the correct type number, voltage and current ratings as referenced in the appropriate locations in the service instructions or on the equipment. Only qualified service personnel should replace fuses.
- To avoid explosion, do not operate this equipment in an explosive atmosphere.
- Qualified service personnel should perform safety checks after any service.







1.2.2 General Cautions



Observe these cautions when operating this equipment:

- If this equipment is used in a manner not specified in this manual, the protection provided by this equipment may be impaired.
- To prevent damage to equipment when replacing fuses, locate and correct the problem that caused the fuse to blow before re-applying power.
- Do not block ventilation openings.
- Do not position this product in such a manner that would make it difficult to disconnect the power cord.
- Position the equipment so that access to the mains disconnect On/Off switch is readily available.
- Use only the specified replacement parts.
- Follow precautions for static sensitive devices when handling this equipment.
- This product should only be powered as described in the manual.
- There are no user-serviceable parts inside the Model 6100 Laser Diode and Temperature Controller .
- Adhere to good laser safety practices when using this equipment.

1.2.3 Summary of Warnings and Cautions

The following general warning and cautions are applicable to this instrument:

	<p style="text-align: center;">WARNING</p> <p>Before operating the Model 6100 Laser Diode and Temperature Controller, please read and understand all of Sections 1 thru 4.</p>
	<p style="text-align: center;">WARNING</p> <p>Do not attempt to operate this equipment if there is evidence of shipping damage or you suspect the unit is damaged. Damaged equipment may present additional hazards to you. Contact Newport technical support for advice before attempting to plug in and operate damaged equipment.</p>
	<p style="text-align: center;">WARNING</p> <p>To avoid electric shock, connect the instrument to properly earth-grounded, 3-prong receptacles only. Failure to observe this precaution can result in severe injury.</p>
	<p style="text-align: center;">WARNING</p> <p>Before cleaning the enclosure of the Model 6100 Laser Diode and Temperature Controller, the AC power cord must be disconnected from the wall socket.</p>
	<p style="text-align: center;">CAUTION</p> <p>There are no user serviceable parts inside the Model 6100 Laser Diode and Temperature Controller. Work performed by persons not authorized by Newport Corporation will void the warranty. For instructions on obtaining warranty repair or service, please refer to Section 8.</p>
	<p style="text-align: center;">WARNING</p> <p>If this equipment is used in a manner not specified in this manual, the protection provided by this equipment may be impaired.</p>

	<h3>WARNING</h3> <p>While the Model 6100's front panel key switch turns power OFF to the internal electronics, it should not be depended upon to fully disconnect the unit from MAINS power. Disconnect the power cord to fully isolate the Model 6100 from MAINS power.</p>
	<p>The Model 6100 is intended for use in an industrial environment. Use of this product in other environments, such as residential, may result in electromagnetic compatibility difficulties due to conducted as well as radiated disturbances.</p>

1.3 Location of Labels and Warnings

1.3.1 Rear Panel

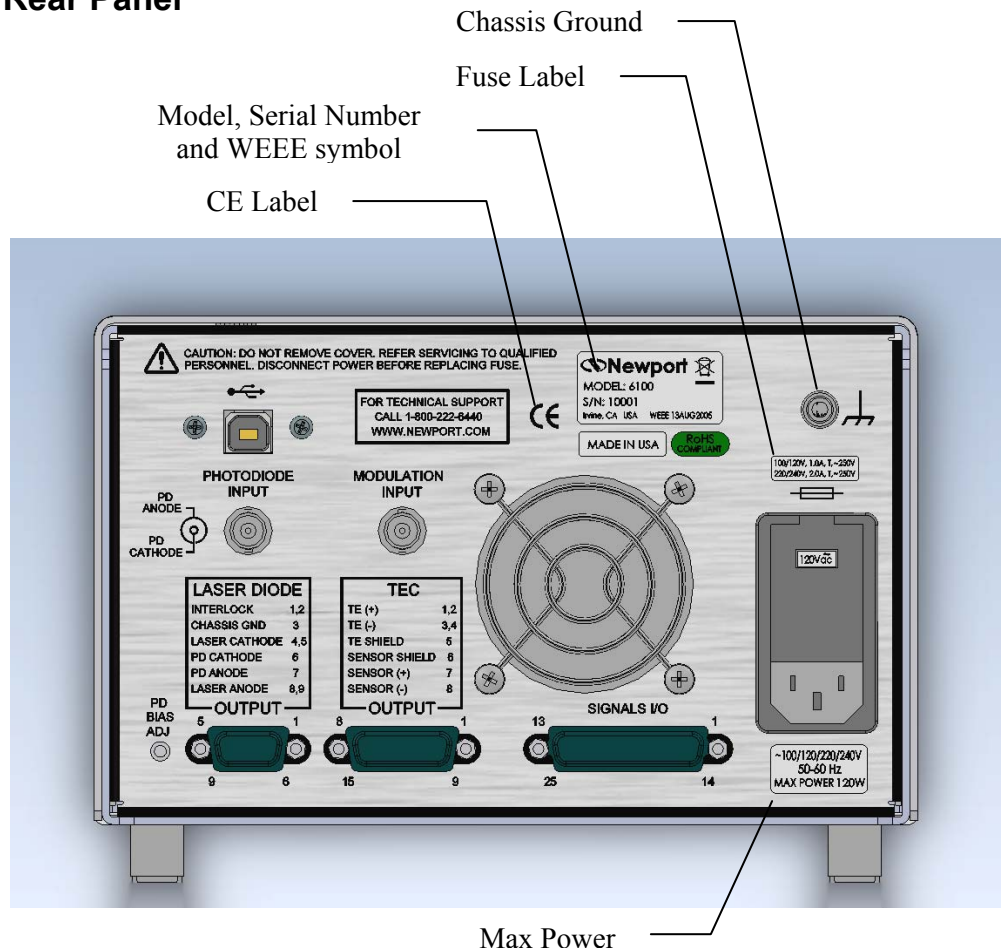

Figure 12 Rear Panel Labels and Warnings

This page is intentionally left blank

2 General Information

2.1 Introduction

Model 6100 Laser Diode and Temperature Controller is the result of Newport's continuing commitment to deliver innovative solutions that enable its customers' success. It offers reliable, high output power at a very competitive price. The ergonomic layout and intuitive front panel controls make this versatile instrument extremely easy to use. A wide range of Laser Diode Driver and TEC temperature control device and user safety features were incorporated into the design of this instrument. The Model 6100 Laser Diode and Temperature Controller complies with applicable CE and CDRH requirements.

Key Product Features:

- USB Plug-and-Play Interface
- Configurable shutdown of the Laser Diode Driver upon detection of a Temperature Controller fault.
- Laser Diode Driver
 - 15 Watt output power
 - Ultra stable output
- Temperature Controller
 - 32 Watt output power
 - Ultra stable bipolar output
 - Support for thermistors, AD590, LM335, and Pt RTD sensors.

2.1.1 Laser Diode Driver Subsystem

The 15 Watt Laser Diode Driver can be operated in one of the following two modes:

- Constant Current
- Constant Power (using the laser diode's back facet diode)

2.1.2 Temperature Controller Subsystem

The 32 Watt Temperature Controller can be operated in one of the following three modes:

- Constant Temperature
- Constant Resistance / Reference
- Constant TE Current

Four sensor types are compatible with this TEC:

- Thermistors
- AD590 series
- LM335 series
- 100 Ω Platinum RTDs

2.1.3 Instrument Features

Intuitive Controls and LCD Display

Improved data presentation and system control are achieved using a combination of LCD and 7-segment LED displays. The LCD display shows the entire system configuration as well as TEC and Laser Diode status. The LED displays show the actual operating point of the attached TEC and laser diode. “Menu Keys” guide you through initial system setup routines and operation. Real-time control of an output is accomplished either by entering the set point via the cursor keys or control knob. SETUP/ENTER and ARROW keys access saved system configurations and repetitive procedures. All controls are clearly marked and instructions easily understood for simple operation.

Support for Remote Data Collection

All control and measurement functions are accessible via the USB interface. As your instrumentation needs change, the Model 6100 Laser Diode and Temperature Controller will adapt to all your new applications giving you the ultimate in flexible laboratory equipment.

2.2 Input Power

The Model 6100 can be configured to operate on 100, 120, 220, or 240 volt AC power. See Section 3.6 for information on how to configure the Model 6100 for operation on your country-specific AC voltage.

2.3 Available Options and Accessories

- 500-02 Laser Diode Driver Cable, DB9 Male to Bare Wire
- 500-04 Laser Diode Driver Cable, DB9 Male to DB9 Female
- 300-02 Temperature Controller Cable, DB15 Male to Bare Wire
- 300-04 Temperature Controller Cable, DB15 Male to DB15 Female

Newport Corporation also supplies temperature controlled mounts and other accessories. Please consult with your representative for additional information.

2.4 Specifications

2.4.1 Laser Diode Driver

Output Connector	DB9	DB9
Output Current		
Range	0 to 500mA	0 to 1500mA
Resolution	7.6 μ A	23 μ A
Accuracy (% of FS)	\pm 0.05%	\pm 0.05%
Short-Term Stability (1 hour) ¹	<50 ppm of FS	<200 ppm of FS
Long-Term Stability (24 hours) ²	<150 ppm of FS	<300 ppm of FS
Temperature Coefficient	<100 ppm/ $^{\circ}$ C	<300 ppm/ $^{\circ}$ C
Noise/Ripple ³		
High Bandwidth Mode (rms)	<20 μ A	<50 μ A
Low Bandwidth Mode (rms)	<10 μ A	<25 μ A
Compliance Voltage (Adjustable)		
Range	0 to 10V	0 to 10V
Resolution	2.5 mV	2.5 mV
Accuracy (% of FS)	\pm 0.8%	\pm 0.8%
Current Limit		
Range	0 to 505mA	0 to 1515mA
Resolution	0.15mA	0.46mA
Accuracy	\pm 0.5mA	\pm 1.5mA
Trigger Input		
Type	Positive edge trigger	Positive edge trigger
Input Signal	5V CMOS	5V CMOS
Input Circuit	680 Ω pull up to +5V	680 Ω pull-up to +5V
Trigger Output		
Programmable Pulse Width Range	0.005 to 9999.5ms	0.005 to 9999.5ms
Type	Positive edge trigger	Positive edge trigger
Output Circuit	Open Collector with 680 Ω pull up to +5V	Open Collector with 680 Ω pull up to +5V
Analog Control Input		
Range	0 to 10V	0 to 10V
Input Impedance	22 k Ω	22 k Ω
Accuracy	\pm 10mV	\pm 10mV

Photodiode Feedback		
Type	Differential	Differential
Range	0 to 5 mA	0 to 5 mA
Reverse Bias	Adjustable, 0 to 5V	Adjustable, 0 to 5V
Output Stability	0.1 μ A	0.1 μ A
Setpoint Accuracy (% of FS)	\pm 0.05%	\pm 0.05%
External Analog Modulation		
Input	-10 to +10V	-10 to +10V
Type	Differential	Differential
Input Impedance	10k Ω	10k Ω
Transfer Function	50mA/V	150mA/V
High Bandwidth	DC to 1.4MHz	DC to 500kHz
Low Bandwidth	DC to 15kHz	DC to 15kHz
LDD Current Monitor (Output)⁵		
Range	0 to 10V	0 to 10V
Transfer Function	50mA/V	150mA/V
Output Impedance	100 Ω	100 Ω
Accuracy (% of FS)	\pm 1%	\pm 1%
LDD Voltage Monitor (Output)⁶		
Range	0 to 10V	0 to 10V
Transfer Function	1V/V	1V/V
Output Impedance	100 Ω	100 Ω
Accuracy (% of FS)	\pm 1%	\pm 1%
Measurement Display		
Output Current		
Range	0 to 500mA	0 to 1500mA
Resolution	0.01mA	0.1mA
Accuracy (% of FS)	\pm 0.05%	\pm 0.05%

Forward Voltage		
Range	0 to 10V	0 to 10V
Resolution	0.1mV	0.1mV
Accuracy (% of FS)	\pm 0.2%	\pm 0.2%
Forward Voltage (Sense Input – 4 Wire Measurement)		
Range	0 to 10V	0 to 10V
Resolution	0.1mV	0.1mV

Accuracy (% of FS)	±0.2%	±0.2%
Photodiode Current		
Range	0 to 5000µA	0 to 5000µA
Resolution	0.01µA	0.01µA
Accuracy (% of FS)	±0.05%	±0.05%
Photodiode Responsivity		
Range ⁷	0.00 to 999.999µA/mW	0.00 to 999.999µA/mW
Resolution	0.001µA/mW	0.001µA/mW
Optical Power		
Range	0.00 to 500.00mW	0.0 to 5000.0mW
Resolution	0.01mW	0.1mW

¹ Measured over one-hour period, half scale output.

² Measured over 24-hour period, half scale output.

³ Measured electrically on a resistive load in the middle of the current range.

⁴ Measured on a resistive load

⁵ This voltage is measured between pins 4 and 17 of the DB-25 SIGNALS I/O Connector. It is proportional with the LDD Output Current

⁶ This voltage is measured between pins 5 and 18 of the DB-25 SIGNALS I/O Connector. It is proportional with the Laser Diode Forward Voltage

⁷ The responsivity value is user defined and is used to calculate the optical power returned by the photodiode

2.4.2 Temperature Controller

	Model 6100
Output Connector	DB15
Maximum Output Power	32W
Output Current	
Type	Bipolar, Constant Current Source
Range	-4 to + 4A
Resolution (manual / remote)	1 mA / 0.1 mA
Accuracy	±4 mA
Noise/Ripple (rms) ¹	<0.5 mA
Compliance Voltage	
Range	-8 to +8V
Current Limit	
Range	0 to 4A
Resolution (manual / remote)	1 mA / 0.1 mA
Accuracy	±0.3%
Stability	
Short term (1 hour)	±0.001°C
Long term (24 hour)	±0.002°C
Display Range	
Temperature	-100.00 to +250.00°C
Resistance Total Range	0.0001 to 250.0kΩ
Resistance at 10μA	0.01 to 250.00kΩ
Resistance at 100μA	0.001 to 25.000kΩ
Resistance at 1mA	0.0001 to 2.5000kΩ
Resistance at 10mA	0.1 to 250.0Ω
Resistance RTD	20 to 192Ω
LM335	2331 to 3731mV
AD590	248.15 to 378.15μA
TE Current	-14.000 to +14.000A
TE Voltage	-24.000 to 24.000V

¹ Noise and rippled measured on a resistive load

Display Resolution	
Temperature	0.001°C
Resistance at 10 μ A	0.01k Ω
Resistance at 100 μ A	0.001k Ω
Resistance at 1 mA	0.0001k Ω
Resistance at 10 mA	0.0001k Ω
Resistance RTD	0.001 Ω
LM335	0.1 mV
AD590	0.01 μ A
TE Current	1 mA
TE Voltage	1 mV
Display Accuracy	
Temperature ²	$\pm 0.001^\circ\text{C}$
Resistance at 1 μ A	$\pm 0.05\%$
Resistance at 10 μ A	$\pm 0.05\%$
Resistance at 100 μ A	$\pm 0.05\%$
Resistance at 1 mA	$\pm 0.05\%$
Resistance at 10 mA	$\pm 0.08\%$
Resistance RTD	$\pm 0.08\%$
LM335 [V]	$\pm 0.05\%$
AD590 [μ A]	$\pm 0.05\%$
TE Current	0.35%
TE Voltage	0.35%

Temperature Sensors	Thermistors	AD590	LM335	RTD (100Ω)
Temperature Control Resolution [$^\circ\text{C}$]	0.0001	0.0001	0.0001	0.0001
Temperature Control Accuracy [$^\circ\text{C}$] ⁹	± 0.001	± 0.03	± 0.03	± 0.001
Sensor Bias Current [mA]	0.001, 0.01, 0.1, 1, 10	—	1	1
Sensor Bias Voltage [V]	—	+ 4	—	—

² Temperature accuracy reflects the accuracy of temperature change measurement. This is the uncertainty that the instrument brings into the measurements and it is not a reflection of the absolute temperature measurement, which depends on the thermistor accuracy.

2.4.3 General Subsystem

Environmental Specifications	
Voltage Requirements	100/120/220/240 VAC, 50/60Hz
Power Requirements	MAX POWER = 140W
Chassis Ground	4 mm banana jack
Size (H x W x D) [in. (mm)]	3.47 (88.14) x 19.00 (482.60) x 12.24 (310.89)
Mainframe Weight [lb (kg)]	11.2 (5.1)
Operating Temperature	0°C to 40°C (<90% humidity non-condensing)
Storage Temperature	-30°C to + 60°C (<90% humidity non-condensing)
Relative Humidity, Storage	<90% humidity non-condensing
Altitude	<3000 meters (10000 feet)
Installation Category	II
Pollution Degree	2
Use Location	Indoor use only
I/O Signals	25-pin female D-sub

This page is intentionally left blank

3 Getting Started

3.1 Unpacking and Handling

It is recommended that the Model 6100 Laser Diode and Temperature Controller be unpacked in a lab environment or work site. Unpack the system carefully; small parts are included with the instrument. Inspect the box carefully for loose parts. You are urged to save the packaging material in case you need to ship your equipment in the future.

3.2 Inspection for Damage

The Model 6100 Laser Diode and Temperature Controller is carefully packaged at the factory to minimize the possibility of damage during shipping. Inspect the box for external signs of damage or mishandling. Inspect the contents for damage. If there is visible damage to the instrument upon receipt, inform the shipping company and Newport Corporation immediately. Carefully open the box and save the shipping material for later use.



WARNING

Do not attempt to operate this equipment if there is evidence of shipping damage or you suspect the unit is damaged. Damaged equipment may present additional hazards to you. Contact Newport technical support for advice before attempting to plug in and operate damaged equipment.



CAUTION

The user is advised to save the packaging material in case the unit has to be shipped to a different location. The packaging material is specially designed to protect the unit during shipping.

3.3 Parts List

The following is a list of parts included with the Model 6100 Laser Diode and Temperature Controller:

1. Start Up Guide (Hardcopy).
2. CD with Software Drivers and Utilities, User's Manual, Start Up Guide.
3. IEC320 AC line cord with a NEMA 5-15P, or country-specific, connector.
4. Mating connector for the Temperature Controller output connector.
5. Mating connector for the Laser Diode Driver output connector with the interlock jumper installed.
6. A pair of keys for the safety keyswitch.

If you are missing any parts or have questions about the parts you have received, please contact Newport Corporation.

3.4 Choosing and Preparing a Suitable Work Surface

The Model 6100 Laser Diode and Temperature Controller may be placed on any reasonably firm table or bench during operation.

3.5 Electrical Requirements

Before attempting to power up the unit for the first time, the following precautions must be followed:



WARNING

To avoid electric shock, connect the instrument to properly earth-grounded, 3-prong receptacles only. Failure to observe this precaution can result in severe injury.

- Have a qualified electrician verify the wall socket that will be used is properly polarized and properly grounded.
- Provide adequate distance between the Models 6100 Laser Diode and Temperature Controller and adjacent walls for ventilation purposes. Do not let any other equipment blow hot air towards the Laser Diode and

Temperature Controller. Verify the correct rated fuses are installed according to the fuse marking on the rear panel.

3.6 Power Supplies



WARNING

To avoid electric shock, the Model 6100 must be configured for operation on your specific AC line voltage **PRIOR TO CONNECTING THE POWER CORD TO THE AC MAINS**. See the instructions above for information

AC power is supplied through the rear panel power entry module connector that provides in-line transient protection and RF filtering. The power entry module also contains the instrument's fuses and the voltage selection switch.

Prior to plugging in the AC line cord, the user **MUST** configure the Model 6100 for operation on the available AC power. This is accomplished by setting the voltage selector switch on the AC power entry module **AND** verifying that the correct fuses are installed into the power entry module. Failure to do this can result in degraded instrument performance, damage to the Model 6100, and / or injury to the operator.

The voltage selector switch and the fuses are accessed by opening the power entry module using a flat-bladed screwdriver. Note that the AC line cord must be removed from the power entry module prior to attempting to open it. With the power entry module open, the voltage selector switch setting can be changed by removing the drum, rotating it to the desired setting, and reinstalling the drum.

After correctly setting the voltage selection switch, the fuses installed in the power entry module should be checked for the correct value and, if not correct, changed.

Table 1, below, identifies the correct voltage selector switch setting and fuse ratings for several common AC power

Input Power	Voltage Switch Setting	Fuses
100 VAC, 50 Hz	100	2A, 250VAC, Slo-Blo
120 VAC, 60 Hz	120	2A, 250VAC, Slo-Blo
220 VAC, 50 Hz	220	1A, 250VAC, Slo-Blo
230 VAC, 50 Hz	230	1A, 250VAC, Slo-Blo
240 VAC, 60 Hz	230	1A, 250VAC, Slo-Blo

Table 1 Voltage Selector Switch Settings and Fuse Ratings

**WARNING**

To avoid electric shock, connect the instrument to properly earth-grounded receptacles only. Failure to observe these precautions can result in fire, severe injury or death.

**WARNING**

To avoid electric shock, the appropriate fuses for the AC input power voltage must be installed in the instrument. Only qualified service personnel should replace fuses. Failure to observe these precautions can result in fire, severe injury or death.

4 System Operation



WARNING

Before operating the Model 6100 Laser Diode and Temperature Controller, please read and understand all of Section 1.

4.1 General Features

The Model 6100 Laser Diode and Temperature Controller is a precision instrument for driving laser diodes (LDs) and their associated thermoelectric cooler controllers (TECs). Features include:

- Closed-case calibration
- Operational with most thermistors, IC and RTD temperature sensors
- LD operation in Constant Current or Constant Power mode (user selectable)
- Flexible setup with Save/Recall front panel functions
- High temperature stability
- Current limit and fault sensing on both the TEC and LD outputs.
- Ability to turn OFF current to a LD if a fault is detected with its associated TEC.

4.1.1 Laser Diode Driver Features

The Laser Diode Driver subsystem of the Model 6100 can be operated in one of the following modes:

- Constant Laser Diode Current
- Constant Photodiode Current
- Constant Photodiode Power

The default mode of operation is Constant Current. The operator can select Constant Power mode by making the desired selection from instrument's front panel menu or by sending appropriate commands to the instrument from a host PC via USB interface (located on the rear of the unit).

Constant Laser Diode (LD) Current Mode (Const Ild)

In Constant Laser Diode Current mode, the operator explicitly sets the amount of current flow through the attached laser diode using the "Ild" variable. The LDD uses a control loop comparing the Model 6100's internal current sense to the current set point, raising or lowering the amount of current to reach and maintain that set point.

Constant Photodiode (PD) Current Mode (Const Ipd)

In Constant Photodiode Current mode, the LDD subsystem holds the attached laser diode output current constant based on feedback from the laser diode's integrated back-facet diode. The LDD uses a control loop comparing the current from the back-facet diode to the current set point (**Ipd**), raising or lowering the output current to reach and maintain that set point.

Constant Photodiode (PD) Power Mode (Const Ppd)

In Constant Photodiode Power mode, the LDD subsystem holds the attached laser diode output power constant based on feedback from the laser diode's integrated back facet diode. The photodiode current measured is converted to optical power based on user specified photodiode responsivity. The LDD uses a control loop comparing the current from the back facet diode to the power set point (**Ppd**), raising or lowering the amount of current to reach and maintain that set point.

4.1.2 Temperature Controller Features

The Temperature Controller subsystem of the Model 6100 can be operated in one of the following modes:

- Constant Temperature
- Constant Resistance / Reference
- Constant Current

The default mode of operation is Constant Laser Diode Current. The operator can select Constant Photodiode Current or Constant Photodiode Power mode by making the desired selection from the instrument's front panel menu or by sending appropriate commands to the instrument from a host PC via USB interface (located on the rear of the unit).

Constant Temperature Mode (Const Temp)

This mode holds the TEC at a constant temperature based on feedback from the sensor in the TEC mount. In this mode, the 6100 uses a control loop comparing the sensor input to the temperature set point (**Ts**), driving the **Ite** current positive or negative to reach and maintain that set point. The thermistor sensor's input is converted to temperature for display of actual TEC temperature using Steinhart-Hart (S-H) equation. The RTD sensor's input is converted to temperature for display of actual TEC temperature using Callendar – van Dusen (C-vD) equation.

The sensor constants (both S-H and C-vD coefficients) can be modified using “TEC:CONST” command or through the front panel.

Constant Resistance/Reference Mode (Const R)

This mode operates identically to the Const Temp mode, but the sensor input is not converted to temperature; it is displayed in unconverted form. Likewise, the set point is used directly, not converted from temperature. Thermistor and RTD sensors use resistance (“**Rs=**” and “**R=**” variables), LM335 sensors use millivolts (“**vs=**” and “**v=**” variables), and AD590 sensors use microamps (“**is=**” and “**i=**” variables). Const R is primarily intended for users who know a sensor set point in “sensor” units, not in °C.

Constant Current Mode (Const Ite)

Unlike the modes above, the Const Current mode allows the operator to explicitly set the amount and direction of current flow through the TEC, using “**Is=**” and “**Ite=**” variables. If a sensor has been selected, the TEC temperature will be displayed. Although temperature is not a factor in the amount or direction of current flow, the high and low temperature limits are observed, and will shutdown the output if exceeded in Const Ite mode, if a sensor is selected. For no temperature limits, set the sensor type to “None.” Use caution when limits are not active, as the temperature may exceed your TEC's thermal limits.

4.2 Safety Features

The Model 6100 Laser Diode and Temperature Controller features a multitude of safety features to help protect the attached laser diodes and TEC coolers.

4.2.1 Conditions Which Will Automatically Shut OFF the Laser Diode Output

- Current Limit
- Open Circuit
- Mode Change
- Range Change
- Bandwidth Change
- Photodiode Responsivity Change
- TEC output is turned OFF,(only when the LD protection feature enabled)

4.2.2 Conditions Which Will Automatically Shut OFF the TEC Output

- High Temperature Limit (Constant Temperature and Constant Current modes only)
- Low Temperature Limit (Constant Temperature and Constant Current modes only)
- High Resistance/Reference Limit (Constant Resistance/Reference mode only)
- Low Resistance/Reference Limit (Constant Resistance/Reference mode only)
- Compliance Voltage Limit
- TEC Open
- Sensor Open
- Sensor Select changed
- Sensor Shorted
- Mode Change

4.2.3 Power Line Surge Protection

The Model 6100 unit contains circuitry to minimize the impact of power line surges. In order to further protect an attached laser diodes and TEC coolers, the 6100 contains circuitry to immediately shut down one or both of the outputs when a large surge is detected.

This secondary protection capability instantly disables an output when it senses that the output's current exceeds 3% of the set current limit or that the

voltage on the output is above the maximum compliance voltage. (Except in the case of very large power line surges, the output currents cannot exceed the user-specified current limits.)

4.3 Front Panel

The front panel of the Model 6100 Laser Diode and Temperature Controller is designed for easy operation. It has various distinct areas, each with a specific set of related functions, and a control knob, as shown in Figure 13 below.

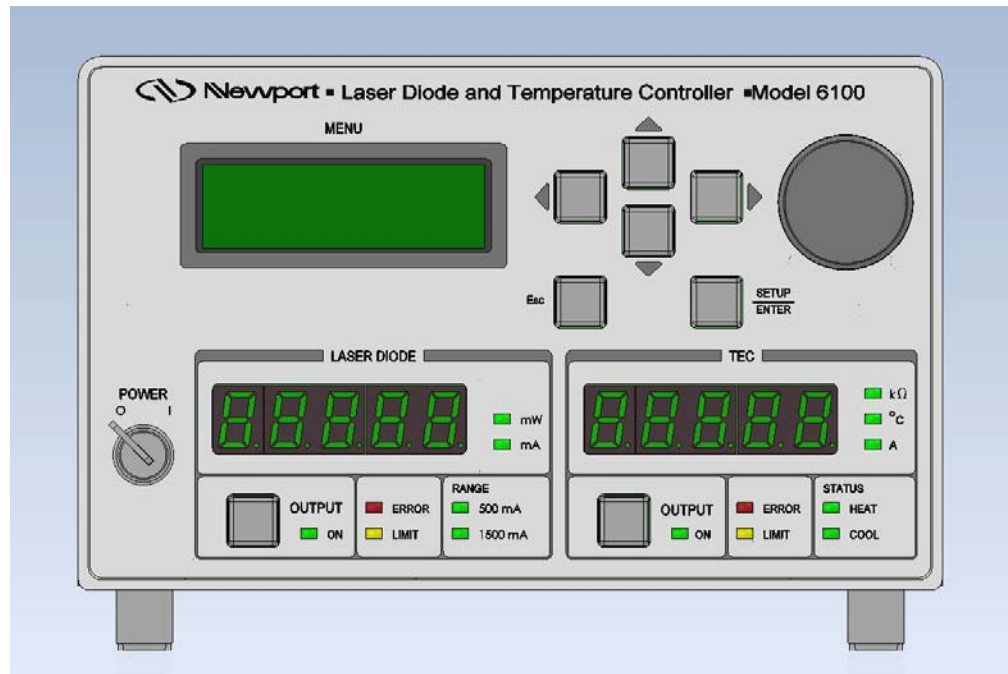

Figure 13 Front Panel Layout

4.3.1 Key Switch

The controller's main electrical power ON / OFF switch is located on the bottom left-hand corner of the front panel. With the 6100 connected to an AC power source, the instrument electrical power is completely turned-OFF when the key switch is in the "0" position. Conversely, the unit's electrical power is turned-ON when the key switch is in the "I" position.

During the power-up sequence, the following take place:

The instrument is restored to the state in which it was last turned OFF.

The Laser Diode and TEC outputs are turned OFF.

The instrument's firmware version is displayed on the LCD screen for a few seconds

The beeper is turned ON, if enabled, briefly.

The 6100 has a key switch for this function, rather than a conventional push button or rocker switch, to meet the CDRH laser safety key switch lockout requirements.

4.3.2 LASER DIODE OUTPUT ON Switch and Indicator

The switch will activate the ON LED and allow current flow to the laser diode after an approximately 3 second delay. (CDRH regulations require a minimum delay of 3 seconds.) Current will not flow unless the laser diode is correctly connected and the interlock pins, pin 1 and 2 of the DB-9 LDD Output Connector (located on the rear panel), are shorted together.

4.3.3 LASER DIODE ERROR Indicator LED

The following conditions will cause the red ERROR LED and its protection circuitry to activate, automatically shutting off the output:

An open circuit in the laser diode package or cabling.

Laser diode oscillation causing current to exceed the previously set current limit value.

Certain external transient events that could damage the laser.

Shutdown of the Temperature Controller Subsystem (if this feature is enabled)

Mode Change

Range Change

Bandwidth Change

Photodiode Responsivity Change

To clear these conditions and to turn OFF the ERROR LED, all the error conditions must be addressed, and the output must be turned ON. See the Commands Section for additional information.

4.3.4 LASER DIODE LIMIT Indicator LED

A soft limit occurs when the output current gradually exceeds a preset value, clamping the current flow at that level or the compliance voltage exceeds preset voltage limit value. These conditions cause the LIMIT LED to blink until they are no longer violated.

ERROR LED	LIMIT LED	CONDITION
ON	ON	((Internal temperature exceeds 80 °C) OR (Rear panel Interlock de-asserted) OR (Hard current limit condition asserted))
OFF	BLINKING	Soft limit condition asserted by circuitry
OFF	OFF	No error condition detected

Table 2 Laser Diode Error and Limit LED Status Definition

4.3.5 LASER DIODE Display Section

The lower-left quadrant of the Model 6100 front panel has a 5 digit green LED array. The table below shows the displayed value and the state of units LEDs based on the LDD mode of operation.

Mode	Displayed Value	“mW” LED	“mA” LED
Constant Laser diode Current	Actual output current	OFF	ON
Constant Photodiode Current	Actual photodiode current	OFF	OFF
Constant Photodiode Power	Actual power	ON	OFF

4.3.6 TEC OUTPUT ON Switch and Indicator

The switch will activate the ON LED and allow current flow to the TEC. Current will not flow unless the TEC is correctly connected and the interlock pins (pin 3 & 4 of the TEC output connector) are not connected one to each other. This is the default behavior. The user can change this state to opposite, and direct the TEC to not turn the output on, unless the interlock pins are connected together, by reprogramming the Interlock Monitor (see HWCONFIG command in Section 5.5).

4.3.7 TEC ERROR Indicator LED

The following conditions will cause the red ERROR LED and its protection circuitry to activate, automatically shutting off the output:

High/Low Temperature Limit (Constant temperature and current modes only)

High/Low Resistance/Reference Limit (Constant resistance/reference mode only)

TEC Open

Sensor Open

Sensor Select changed

Sensor Shorted

Mode Change

To clear these conditions and to turn OFF the ERROR LED, all the error conditions must be addressed, and the output must be turned ON. See the Commands Section for additional information.

4.3.8 TEC LIMIT Indicator LED

A soft limit occurs when the output current exceeds a preset limit value, clamping the current flow at that level and causing the LIMIT LED to blink. The LIMIT LED stops blinking and is turned OFF automatically when the output current does not exceed the current limit.

ERROR LED	LIMIT LED	CONDITION
ON	ON	((Interlock asserted) OR (Internal temperature exceeds 80 °C) OR (Sensor Short) OR (Sensor Open) OR (Compliance voltage exceeds 10.3V) OR (Temperature outside T_High and T_Low limit settings) OR (Resistance outside R_High and R_Low limit settings))
OFF	BLINKING	((Output current exceeds current limit) OR (Compliance voltage exceeds voltage limit))
OFF	OFF	No error condition detected

Table 3 TEC Error and Limit LED Status Definition

4.3.9 TEC Status LEDs

The HEAT and COOL STATUS LEDs indicate if the Temperature Controller Subsystem is attempting to raise or lower the temperature of the attached TEC.

4.3.10 TEC DISPLAY Section

The lower-right quadrant of the Model 6100 front panel has a 5 digit green LED array. The table below shows the displayed value and the state of units LEDs based on the TEC mode of operation.

Mode	Displayed Value	“kΩ” LED	“°C” LED	“A” LED
Constant Current	Actual output current	OFF	OFF	ON
Constant Temperature	Actual temperature	OFF	ON	OFF
Constant Resistance / Reference	Actual resistance / reference	ON only if sensor is thermistor.	OFF	OFF

4.4 Menu Section

In addition to displaying status parameters on the two 5-segment LED displays (bottom sections) of the instrument, the Menu (top section) section of the Model 6100 front panel enables users to view/change many more parameters including feedback sensor type, PID values, and Steinhart-Hart or Callendar – van Dusen coefficients, for example. Prior error messages can be viewed as well.

4.4.1 Control Knob

The control knob on the right side of the front panel is used to set the value of parameters such as Laser diode current setpoint (Ild), TEC temperature setpoint (Ts) etc. Users can select the parameter whose value needs to be modified using the Setup/Enter and Cursor Arrow keys, and then modify the values with the knob. Alternately, the parameters' values can be modified with the Arrow keys.

The knob has an acceleration algorithm that causes the rate of change of value to increase as the knob is turned faster. Turning slowly allows for a fine adjustment at the smallest displayed decimal place.

4.4.2 Setup / Enter

The Setup/Enter key is used to (a) invoke the Setup screen, (b) accept parameter change, or (c) enter a lower menu level, depending on the screen displayed.

4.4.3 Esc

The Esc key is used to (a) cancel a parameter change or (b) back up one menu level.

4.4.4 Cursor Arrow Keys

Moves cursor up or down or between editable data fields. The down arrow decrements values in numerical entry fields, or selects a previous choice in a multi-choice entry field. The up arrow increments values in numerical entry fields, or selects a next choice in multi-choice entry fields. The right and left arrow keys are used to move the cursor position in numerical entry fields.

4.4.5 Display Elements

The Model 6100 uses a character display to depict information about the current state of the system. The display screens shown by the instrument can be classified as follows: title screen, measurement screen, setup screen and error message screen.

4.4.6 Menu Selection

All information displayed in various 6100 screens, with the exception of title screen and error message screen, can be in one of two states: *selected* or *unselected*. A selected item can be in one of two states: *idle* or *active*.

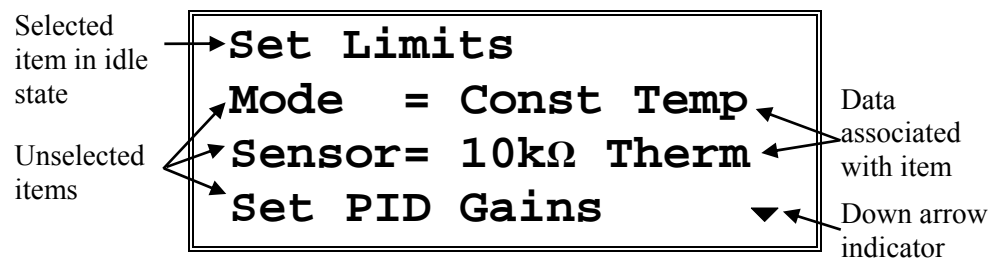

Figure 14 A Sample Setup Screen

A *selected* item in *idle* state is indicated by a diamond symbol (◆) placed to the left of the item. The idle state is the default state for a selected item. In this state, the present value of the item may be displayed next to the label depending upon the type of item. Pressing the SETUP/ENTER key will cause the instrument to display a sub-menu for that item, should one be available. Otherwise, it will change the display state for that item from *idle* to *active*.

A *selected* item in *active* state is indicated by flashing data associated with that item. The cursor arrow keys can be used to modify the data (numerical or non-numerical). Once the data has been modified, pressing SETUP/ENTER key will cause the instrument to accept the new data and return the item to idle state. Pressing the Esc key will cause the display to ignore any changes made, and return to the previous menu.

An *unselected* item simply displays the item name. Depending upon the item (Mode, Sensor, Setpoint), it may also display data associated with that item.

The Setup screens also have up (▲) and down (▼) indicators to show that more items can be accessed by pressing UP and DOWN arrow keys respectively.

4.4.7 Title Screen

The title screen is displayed for a few seconds every time the instrument is powered ON. This screen is used to display the present firmware version of the instrument. A sample title screen is shown in Figure 15.

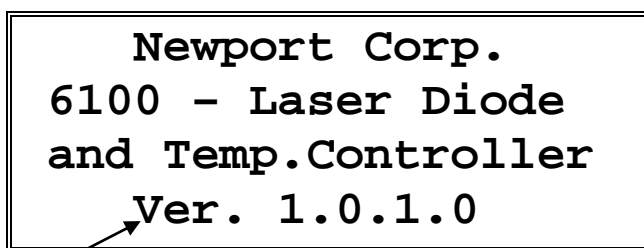

Firmware version
number

Figure 15 A Sample Title Screen

4.4.8 Measurement Screen

The measurement screen is displayed after the instrument has been powered ON for a few seconds. This is the topmost level display during normal operation, and it indicates the status of the instrument. The instrument supports four different measurement screens: LDD and TEC Params screen, LDD Params screen, TEC Params screen and LIV Params screen.

4.4.8.1 LDD and TEC Params Measurement Screen

A sample LDD and TEC Params measurement screen is shown in Figure 16.

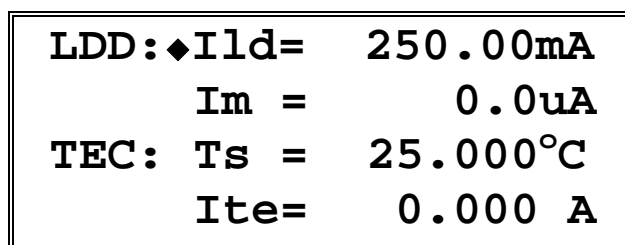

Figure 16 A Sample LDD and TEC Params Measurement Screen

In this screen, the most important parameters related to LDD and TEC are shown. The contents of this screen can vary depending upon the mode of operation. See table below for details.

LDD Parameters:

LDD Mode	Parameter 1	Parameter 2
Constant LD Current	Laser Diode Current Setpoint (Ild)	Actual Photodiode Current (Im)
Constant PD Current	Photodiode Current Setpoint (Ipd)	Actual Laser Diode Current (Io)
Constant PD Power	Photodiode Power Setpoint (Ppd)	Actual Laser Diode Current (Io)

TEC Parameters:

TEC Mode	Parameter 1	Parameter 2
Constant Current	Output Current Setpoint (Is)	Actual Temperature (T)
Constant Resistance/Reference	Resistance/Reference Setpoint (Rs)	Actual Output Current (Ite)
Constant Temperature	Temperature Setpoint (Ts)	Actual Output Current (Ite)

Users can modify the setpoints for both LDD and TEC from this screen. A diamond symbol (◆) to the left of the setpoint variable indicates the “selected” parameter; selected parameters are those that can be modified through either the Control Knob or Cursor Arrow Keys.

Some messages are displayed on this screen to draw users’ attention to various events that may require them to take corrective action(s). For instance, a flashing “E” symbol is shown on the left-top corner of the display whenever the instrument generates an error message.

4.4.8.2 LDD Params Measurement Screen

A sample LDD Params measurement screen is shown in Figure 16.

LDD:◆Ild=	250.00mA
Mode=	LD Curr
Im =	0.0uA
Vf =	0.000 V

Figure 17 A Sample LDD Params Measurement Screen

In this screen, the most important parameters related to LDD are shown. The contents of this screen can vary depending upon the mode of operation. See table below for details.

LDD Mode	Parameter 1	Parameter 3
Constant LD Current	Laser Diode Current Setpoint (Ild)	Actual Photodiode Current (Im)
Constant PD Current	Photodiode Current Setpoint (Ipd)	Actual Laser Diode Current (Io)
Constant PD Power	Photodiode Power Setpoint (Ppd)	Actual Laser Diode Current (Io)

Users can modify the setpoints for LDD only from this screen. A diamond symbol (◆) to the left of the setpoint variable indicates the “selected” parameter; selected parameters are those that can be modified through either the Control Knob or Cursor Arrow Keys.

Some messages are displayed on this screen to draw users’ attention to various events that may require them to take corrective action(s). For instance, a flashing “E” symbol is shown on the left-top corner of the display whenever the instrument generates an error message.

4.4.8.3 TEC Params Measurement Screen

A sample TEC Params measurement screen is shown in Figure 16.

TEC:◆Ts = 25.000°C
Mode= Temp
Ite= 0.000 A
Vte= 0.000 V

Figure 18 A Sample TEC Params Measurement Screen

In this screen, the most important parameters related to TEC are shown. The contents of this screen can vary depending upon the mode of operation. See table below for details.

TEC Mode	Parameter 1	Parameter 3
Constant Current	Output Current Setpoint (Is)	Actual Temperature (T)
Constant Resistance/Reference	Resistance/Reference Setpoint (Rs)	Actual Output Current (Ite)
Constant Temperature	Temperature Setpoint (Ts)	Actual Output Current (Ite)

Users can modify the setpoints for TEC only from this screen. A diamond symbol (◆) to the left of the setpoint variable indicates the “selected” parameter; selected parameters are those that can be modified through either the Control Knob or Cursor Arrow Keys.

Some messages are displayed on this screen to draw users’ attention to various events that may require them to take corrective action(s). For instance, a flashing “E” symbol is shown on the left-top corner of the display whenever the instrument generates an error message.

4.4.8.4 LIV Params Measurement Screen

A sample LIV Params measurement screen is shown in Figure 16.

LIV:◆Ild	=	0.00mA
Im	=	0.0uA
Vf	=	0.000 V
Va	=	0.000 V

Figure 19 A Sample LIV Params Measurement Screen

In this screen, the most important parameters related to LIV are shown. While the main purpose of this screen is to view the state of various LIV related parameters, this screen can be used to adjust LDD setpoint. The contents of this screen can vary depending upon the mode of operation. See table below for details.

LDD Mode	Parameter 1	Parameter 2
Constant LD Current	Laser Diode Current Setpoint (I_{ld})	Actual Photodiode Current (I_m)
Constant PD Current	Photodiode Current Setpoint (I_{pd})	Actual Laser Diode Current (I_o)
Constant PD Power	Photodiode Power Setpoint (P_{pd})	Actual Laser Diode Current (I_o)

The third and fourth parameters displayed on this screen are: LD Forward voltage (V_f) and Analog input (V_a).

4.4.9 Setup Screens

The setup screens are used to modify LDD, TEC and system settings. These screens can be accessed from the Measurement Screens by pressing the Setup/Enter key.

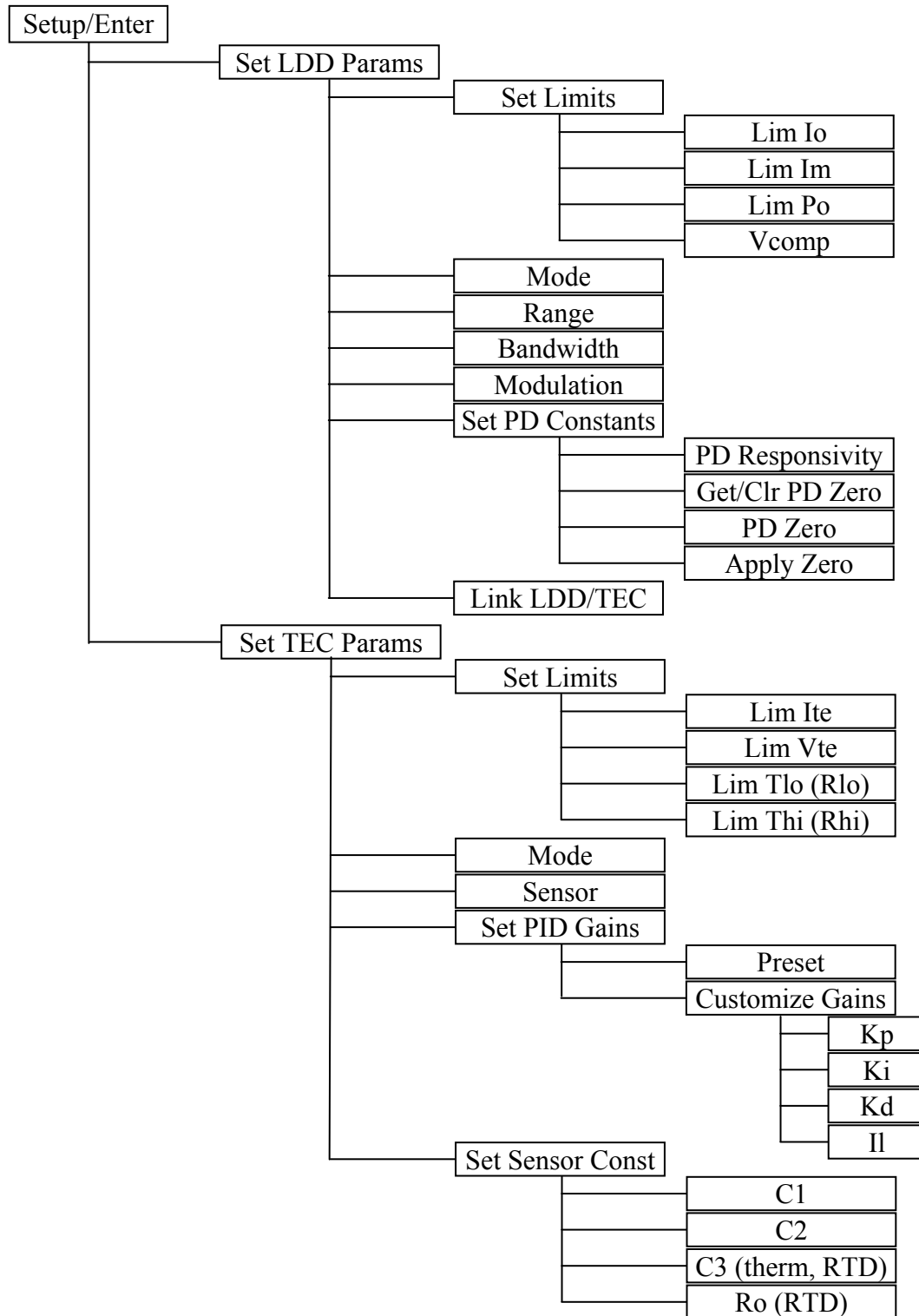

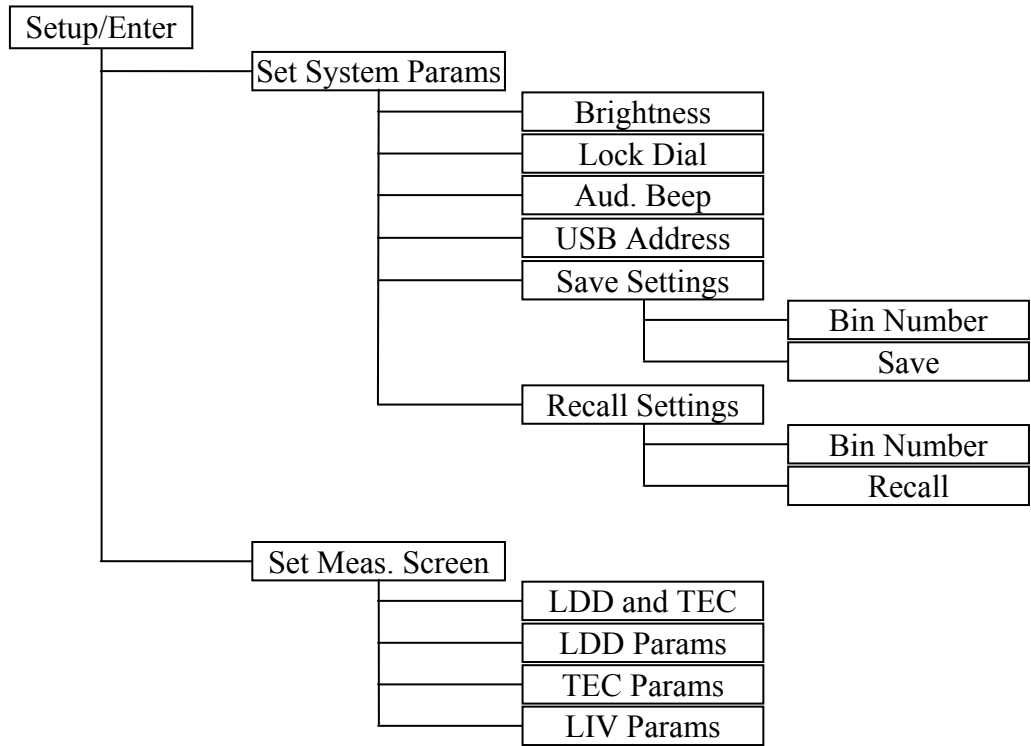

Figure 20 Model 6100 Menu Structure

4.4.9.1 Set LDD Params Menu

The Set LDD Params Menu is used to change parameters related to LDD operation. These parameters, as shown in the menu structure above, are: safety limits, mode of operation, current range, bandwidth, modulation state and photodiode responsivity.

To modify LDD parameters, press the SETUP/ENTER key when the instrument is displaying the Measurement Screen. Press the UP and DOWN arrow keys to select this menu item. Press the SETUP/ENTER key again to enter a sub-menu for this item. A sample sub-menu for setting the LDD Params is shown in figure below.

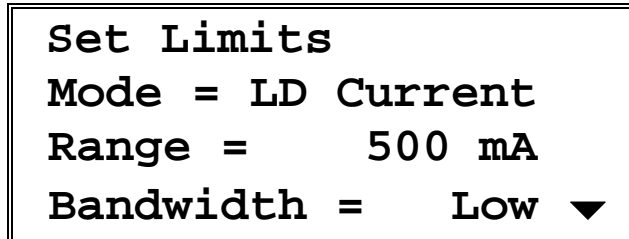

Figure 21 A Sample Set LDD Params Sub-menu

Set Limits Menu

The Set Limits menu item is used to change the limit settings—LD Current, PD Current, PD Power and Compliance Voltage limits.

To set the desired limits, use the UP and DOWN arrow keys to select this menu item. Press the SETUP/ENTER key to enter a sub-menu for this item. A sample sub-menu for setting the limits is shown in figure below. Use the UP and DOWN arrow keys to select a desired sub-menu item. By default, this item will be in idle state and the present limit value will be displayed. Press the SETUP/ENTER key to change this item's state from idle to active. Once the item is in active state, the leading indicator begins flashing. Use the cursor arrow keys to select the desired digit and to increment/decrement the value. Once the desired value has been entered, press SETUP/ENTER key to accept the new limit value. The new limit value will take effect immediately, and the menu item will be returned to idle state. Press Esc key to cancel any changes or to return to Set Limits main menu.

Lim Io = 40.00 mA
Lim Im = 5000.0 uA
Lim Po = Zero Resp
Vcomp = 2.500 V

The PD Power limit will display the text, “Zero Resp”, when the PD responsivity is set to zero. In this state, the valid LDD modes of operation are: LD Current and PD Current. The instrument does not allow users to select “PD Power” mode of operation. A desired PD Power limit can be defined after changing the PD responsivity to a non-zero value.

Mode Menu

The Mode menu item is used to change the instrument's LDD mode of operation (LD Current, PD Current or PD Power).

To set the desired mode of operation, use the UP and DOWN arrow keys to select this menu item. By default, this item will be in idle state and the present mode of operation will be displayed next to the “Mode =” label. Press the SETUP/ENTER key to change this item's state from idle to active. Once the item is in active state, the present mode begins flashing. Use the UP and DOWN arrow keys to select the desired mode and press SETUP/ENTER key to accept the new mode. The new mode will take effect immediately, and the menu item will be returned to idle state. Press Esc key to cancel any changes.

Range Menu

The Range menu item is used to change the instrument's LDD current range (500mA or 1500mA).

To set the desired current range, use the UP and DOWN arrow keys to select this menu item. By default, this item will be in idle state and the present range will be displayed next to the "Range =" label. Press the SETUP/ENTER key to change this item's state from idle to active. Once the item is in active state, the present range begins flashing. Use the UP and DOWN arrow keys to select the desired range and press SETUP/ENTER key to accept the new range. The new range will take effect immediately, and the menu item will be returned to idle state. Press Esc key to cancel any changes.

Bandwidth Menu

The Bandwidth menu item is used to change the instrument's LDD current bandwidth (Low or High).

To set the desired current bandwidth, use the UP and DOWN arrow keys to select this menu item. By default, this item will be in idle state and the present bandwidth will be displayed next to the "Bandwidth =" label. Press the SETUP/ENTER key to change this item's state from idle to active. Once the item is in active state, the present bandwidth begins flashing. Use the UP and DOWN arrow keys to select the desired bandwidth and press SETUP/ENTER key to accept the new bandwidth. The new bandwidth will take effect immediately, and the menu item will be returned to idle state. Press Esc key to cancel any changes.

Modulation Menu

	WARNING When using the current modulation feature, ensure that the modulation signal source is disabled before enabling the 6100 laser current output. Turning on the laser current output when the modulation is enabled can cause current transients that can damage laser diodes.
---	---

The Modulation menu item is used to change the instrument's LDD current modulation state (Off or On).

To set the desired current modulation state, use the UP and DOWN arrow keys to select this menu item. By default, this item will be in idle state and the present modulation state will be displayed next to the "Modulation =" label. Press the SETUP/ENTER key to change this item's state from idle to active. Once the item is in active state, the present modulation state begins flashing. Use the UP and DOWN arrow keys to select the desired modulation

state and press SETUP/ENTER key to accept the new modulation state. The new modulation state will take effect immediately, and the menu item will be returned to idle state. Press Esc key to cancel any changes.

Set PD Constants Menu

The Set PD Constants menu item is used to change the photodiode related settings—PD Responsivity, Zero the PD Current reading by either capturing the present PD Current measurement or by entering a desired value, Set a flag to apply the Zero value or otherwise.

To set the desired PD related settings, use the UP and DOWN arrow keys to select this menu item. Press the SETUP/ENTER key to enter a sub-menu for this item. A sample sub-menu is shown in figure below. Use the UP and DOWN arrow keys to select a desired sub-menu item. Press the SETUP/ENTER key to change this item's state from idle to active. Once the item is in active state, the leading indicator begins flashing. Use the cursor arrow keys to select the desired digit and to increment/decrement the value. Once the desired value has been entered, press SETUP/ENTER key to accept the new value. The new value will take effect immediately, and the menu item will be returned to idle state. Press Esc key to cancel any changes or to return to Set PD Constants main menu.

Resp=	0.000uA/mW
Get/Clear PD Zero	
PD Zero =	0.0 uA
Apply Zero =	No

Link LDD/TEC Menu

The Link LDD/TEC menu item is used to change the LDD output requirement to have TEC output ON prior to turning LDD output ON. This setting is also used to set whether LDD output should be disabled automatically if TEC output gets disabled.

To set the desired LDD safety state, use the UP and DOWN arrow keys to select this menu item. By default, this item will be in idle state and the present selection will be displayed next to the “Link LDD/TEC =” label. Press the SETUP/ENTER key to change this item's state from idle to active. Once the item is in active state, the present selection begins flashing. Use the UP and DOWN arrow keys to select the desired option and press SETUP/ENTER key to accept the new option. The new LDD safety state will take effect immediately, and the menu item will be returned to idle state. Press Esc key to cancel any changes.

4.4.9.2 Set TEC Params Menu

The Set TEC Params Menu is used to change parameters related to TEC operation. These parameters, as shown in the menu structure above, are: safety limits, mode of operation, feedback sensor type, PID control loop gains, and feedback sensor constants.

To modify TEC parameters, press the SETUP/ENTER key when the instrument is displaying the Measurement Screen. Press the UP and DOWN arrow keys to select this menu item. Press the SETUP/ENTER key again to enter a sub-menu for this item. A sample sub-menu for setting the TEC Params is shown in figure below.

```
Set Limits
Mode = Const Temp
Sensor= 10kΩ Therm
Set PID Gains ▼
```

Figure 22 A Sample Set TEC Params Sub-menu

Set Limits Menu

The Set Limits menu item is used to change the limit settings—current limit, voltage limit, temperature limits (in Constant Temperature mode) and resistance limits (in Constant Resistance mode).

To set the desired limits, use the UP and DOWN arrow keys to select this menu item. Press the SETUP/ENTER key to enter a sub-menu for this item. A sample sub-menu for setting the limits is shown in figure below. Use the UP and DOWN arrow keys to select a desired sub-menu item. By default, this item will be in idle state and the present limit value will be displayed. Press the SETUP/ENTER key to change this item's state from idle to active. Once the item is in active state, the leading indicator begins flashing. Use the cursor arrow keys to select the desired digit and to increment/decrement the value. Once the desired value has been entered, press SETUP/ENTER key to accept the new limit value. The new limit value will take effect immediately, and the menu item will be returned to idle state. Press Esc key to cancel any changes or to return to Set Limits main menu.

```
Lim Ite= 5.000 A
Lim Vte= 10.000 V
Lim Tlo= 15.00°C
Lim Thi= 35.00°C
```

*Figure 23 A Sample Set Limits Sub-menu***Mode Menu**

The Mode menu item is used to change the instrument's TEC mode of operation.

To set the desired mode of operation, use the UP and DOWN arrow keys to select this menu item. By default, this item will be in idle state and the present mode of operation will be displayed next to the "Mode =" label. Press the SETUP/ENTER key to change this item's state from idle to active. Once the item is in active state, the present mode begins flashing. Use the UP and DOWN arrow keys to select the desired mode and press SETUP/ENTER key to accept the new mode. The new mode will take effect immediately, and the menu item will be returned to idle state. Press Esc key to cancel any changes.

Sensor Menu

The Sensor menu item is used to change the feedback sensor.

To set the desired sensor type, use the UP and DOWN arrow keys to select this menu item. By default, this item will be in idle state and the present sensor selection will be displayed next to the "Sensor =" label. Press the SETUP/ENTER key to change this item's state from idle to active. Once the item is in active state, the present sensor begins flashing. Use the UP and DOWN arrow keys to select the desired sensor and press SETUP/ENTER key to accept the new sensor. The new sensor selection will take effect immediately, and the menu item will be returned to idle state. Press Esc key to cancel any changes.

Set PID Gains Menu

The Set PID Gains menu item is used to change the PID control loop gains. These gains are used by the instrument to maintain the present temperature (in Constant Temperature mode) or resistance (in Constant Resistance mode) at their setpoint level; they are not used when the instrument is operated in Constant Current mode.

To select preset PID gains or to customize them, use the UP and DOWN arrow keys to select the Set PID Gains menu item. Press the SETUP/ENTER key to enter a sub-menu for this item. A sample sub-menu for setting the gains is shown in figure below.

<p>Preset= Preset 000 Customize Gains</p>

Figure 24 A Sample Set PID Gains Sub-menu

To select a preset PID gains bin, use the UP and DOWN arrow keys to select Preset sub-menu item. By default, this item will be in idle state and the present Preset bin number value will be displayed. Press the SETUP/ENTER key to change this item's state from idle to active. Once the item is in active state, the bin number begins flashing. Use the UP/DOWN arrow keys to select the desired bin number. Once the desired value has been selected, press SETUP/ENTER key to accept the new value. The PID gains associated with the new bin will take effect immediately, and the menu item will be returned to idle state. Press Esc key to cancel any changes or to return to Set PID Gains main menu.

To customize PID gains, use the UP and DOWN arrow keys to select Customize Gains sub-menu item. Press the SETUP/ENTER key to enter a sub-menu for this item. A sample sub-menu for customizing the gains is shown in figure below.

Kp	=	1.000
Ki	=	0.005
Kd	=	1.000
I1	=	10.000

Figure 25 A Sample Customize PID Gains Sub-menu

Use the UP and DOWN arrow keys to select the PID gain that needs to be modified. Once the desired item has been selected, press the SETUP/ENTER key to change the item's state from idle to active. Once the item is in active state, the leading digit begins flashing. Use the cursor keys to specify a desired value. Once the desired value has been selected, press SETUP/ENTER key to accept the new value. The new PID gain will take effect immediately, and the menu item will be returned to idle state. Press Esc key to cancel any changes or to return to Set PID Gains main menu.

It is highly recommended that the output be turned OFF before the gains are customized.

Set Sensor Constants Menu

The Set Sensor Constants menu item is used to change the constants for the previously selected sensor. These constants are used to convert feedback signal from resistance (if sensor is a thermistor or an RTD) or voltage (if sensor is LM335) or current (if sensor is AD590) to temperature. Please refer

the description of TEC:CONST command for further details on these constants.

To modify these constants, use the UP and DOWN arrow keys to select this menu item. Press the SETUP/ENTER key to enter a sub-menu for this item. A sample sub-menu for setting the sensor constants is shown in figure below. The contents of this screen will vary depending upon the sensor selected.

C1	=	1.129
C2	=	2.341
C3	=	0.877

Figure 26 A Sample Sensor Constants Sub-menu

Use the UP and DOWN arrow keys to select the sensor constant that needs to be modified. Once the desired item has been selected, press the SETUP/ENTER key to change the item's state from idle to active. Once the item is in active state, the leading digit begins flashing. Use the cursor keys to specify a desired value. Once the desired value has been selected, press SETUP/ENTER key to accept the new value. The new sensor constant will take effect immediately, and the menu item will be returned to idle state. Press Esc key to cancel any changes or to return to Set Sensor Constants main menu.

It is highly recommended that the output be turned OFF before the gains are customized.

4.4.9.3 Set System Params Menu

The Set System Params menu item is used to change display brightness, lock the dial on the front panel, turn beeper ON/OFF, USB address, and to save/recall system settings

To modify these constants, use the UP and DOWN arrow keys to select this menu item. Press the SETUP/ENTER key to enter a sub-menu for this item. A sample sub-menu for setting the system parameters is shown in figure below.

Brightness	=	100%
Lock Dial	=	No
Aud. Beep	=	Yes
USB Address	=	1 ▼

Figure 27 A Sample System Parameters Sub-menu

Use the UP and DOWN arrow keys to select the parameter that needs to be modified. Once the desired item has been selected, press the SETUP/ENTER key to change the item's state from idle to active. Once the item is in active state, use the cursor keys to specify a desired value. Once the desired value has been selected, press SETUP/ENTER key to accept the new value. The new parameters will take effect immediately, and the menu item will be returned to idle state. Press Esc key to cancel any changes or to return to Set System Params main menu.

Save Settings Menu

The Save Settings menu item is used to store the instrument's setup configurations for future use. For example, a specific test setup may be saved for later use, and then another setup may be used presently. When the user desires to perform the specific test, its setup is simply recalled.

Non-volatile flash memory is used for saving the instrument's parameters. When a save operation is performed, all of the parameters which are currently in effect on the instrument are stored. The user selects a "bin" number for saving the parameters, up to the maximum available in the instrument. Then, when that "bin" number is recalled, the instrument is reconfigured to the previously stored values. A special "bin 0" is reserved for the reset state. Recalling bin 0 will reset the unit to factory defaults.

To perform the save operation, use the UP and DOWN arrow keys to select this menu item. Press the SETUP/ENTER key to enter a sub-menu for this item. A sample sub-menu for setting the system parameters is shown in figure below.

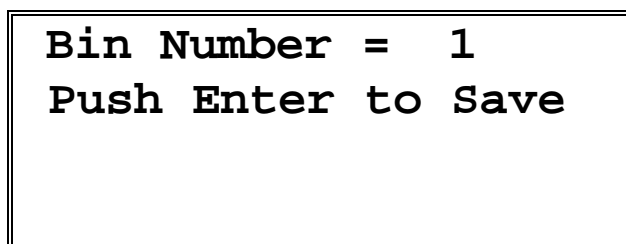

Bin Number = 1
Push Enter to Save

Figure 28 A Sample Save Parameters Sub-menu

Use the UP arrow key to select the Bin Number. Press the SETUP/ENTER key to change the Bin Number menu state from idle to active. Once the item is in active state, use the cursor keys to select the desired bin number. Press SETUP/ENTER key to accept the desired bin.

Now, use the DOWN arrow key to select the menu item that states “Press Enter to Save”. Press SETUP/ENTER key with this menu item selected to save the system settings to the bin number selected earlier. The instrument will automatically return to the Measurement screen once the saving process has completed.

Recall Settings Menu

The Recall Settings menu item is used to recall previously saved instrument’s setup configurations. Recalling bin 0 will reset the unit to factory defaults.

To perform the recall operation, use the UP and DOWN arrow keys to select this menu item. Press the SETUP/ENTER key to enter a sub-menu for this item. A sample sub-menu for recalling the system parameters is shown in figure below.

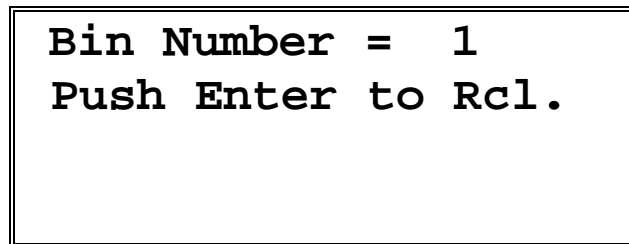

```
Bin Number = 1
Push Enter to Rcl.
```

Figure 29 A Sample Save Parameters Sub-menu

Use the UP arrow key to select the Bin Number. Press the SETUP/ENTER key to change the Bin Number menu state from idle to active. Once the item is in active state, use the cursor keys to select the desired bin number. Press SETUP/ENTER key to accept the desired bin.

Now, use the DOWN arrow key to select the menu item that states “Press Enter to Rcl”. Press SETUP/ENTER key with this menu item selected to recall the system settings from the bin number selected earlier. The instrument will automatically return to the Measurement screen once the recalling process has completed.

4.4.9.4 Set Meas. Screen Menu

The Set Meas. Screen menu item is used to change the main measurement screen: LDD and TEC Params or LDD Params or TEC Params or LIV Params.

To select the desired measurement screen, use the UP and DOWN arrow keys to select this menu item. Press the SETUP/ENTER key to enter a sub-menu for this item. A sample sub-menu for selecting the measurement screen is shown in figure below.

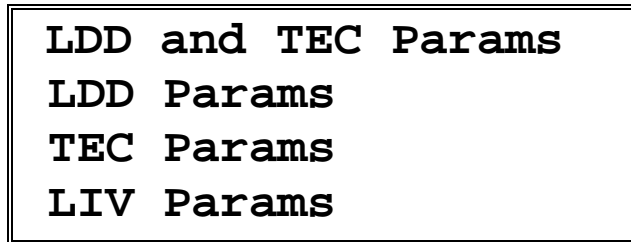

Figure 30 A Sample Measurement Screen Sub-menu

Use the UP and DOWN arrow keys to select the desired measurement screen. Once the desired item has been selected, press the SETUP/ENTER key to accept the new selection. The new selection will take effect immediately, and the unit returns to the main measurement screen. Press Esc key to return to Set Meas. Screen main menu.

4.4.9.5 Error Message Screen

Whenever the instrument generates an error message, a flashing “E” symbol is shown on the left-top corner of the Measurement screen as shown in figure below. Users can retrieve this error message from the instrument from the Error Message screen. To retrieve error messages, press the SETUP/ENTER key to view the setup menu. The first menu item will be “GET ERRORS” as shown in the figure below.

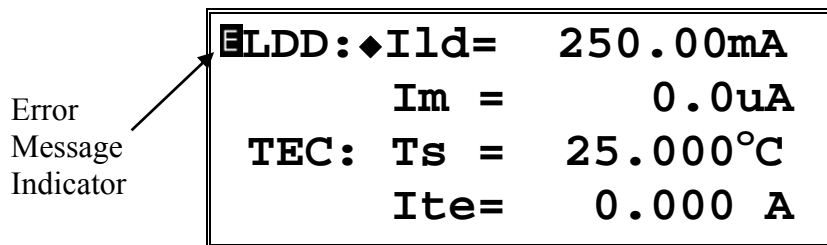

Figure 31 A Sample Measurement Screen when Errors Present

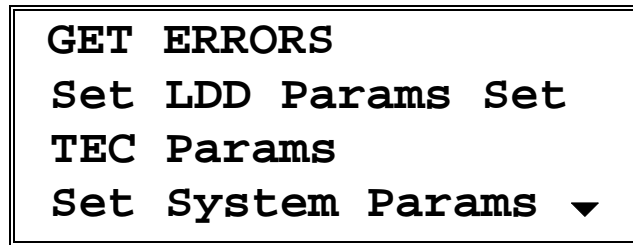

Figure 32 A Sample Setup Screen when Errors Present

Select the Get Errors menu item by pressing the UP arrow key. Once this item is selected press SETUP/ENTER key to enter the Error Messages screen. All the error messages generated are listed on this screen in a chronological order (oldest first). All the error messages can be viewed by pressing the UP and DOWN arrow keys. Press the Esc key to return to the Setup screen. Note that this process removes the errors from error buffer, and they will not be available for querying via USB communication interface.

4.5 Rear Panel

The Model 6100 rear panel has a TEC OUTPUT connector, a LASER DIODE OUTPUT connector, SIGNALS I/O connector, a USB connector, a MODULATION INPUT connector, a PHOTODIODE INPUT, a Photodiode bias adjustment potentiometer, and the AC power entry module.

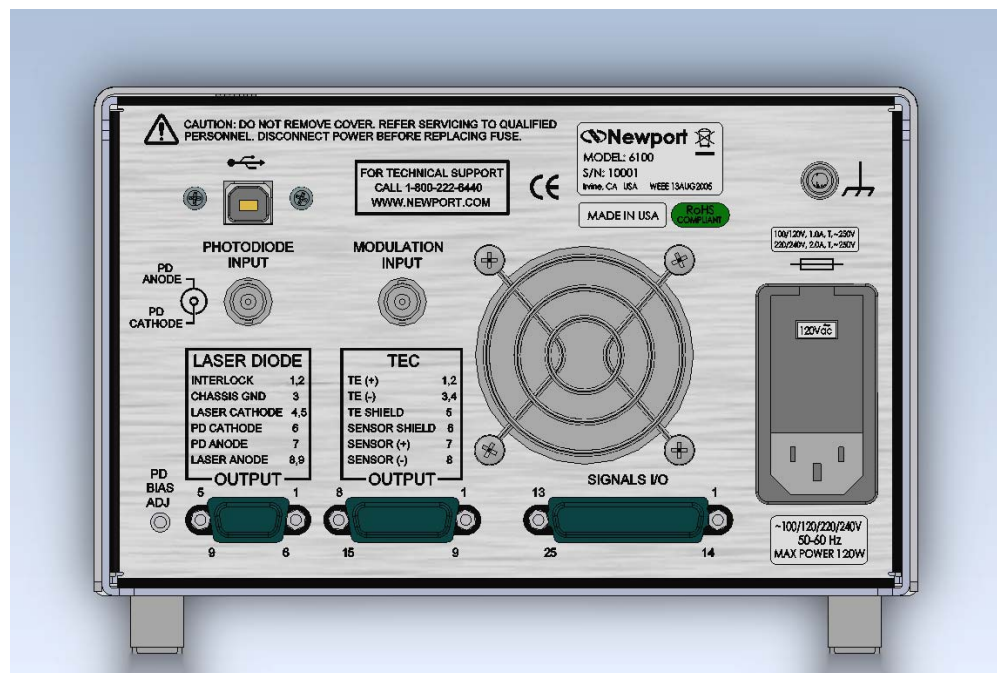

Figure 33 Rear Panel

4.5.1 USB Interface

The instrument is designed to communicate with standard USB Host interfaces. The connector on the rear panel is a standard USB-B (Full-Size, Device).

4.5.2 Chassis GND

This 4 mm banana jack is connected to chassis ground. It is intended to be used as an additional earth ground connection for the Model 6100's enclosure.

4.5.3 AC Power Cord

The Model 6100 can be operated on either 50 or 60 Hz mains power. The instrument can be configured for operation at the following nominal AC line voltages -- 100, 120, 220, 230, or 240 VAC. See section 3.6 for information on properly configuring the Model 6100 for the available mains power.

The line cord supplied with each unit should be plugged only into a properly grounded outlet to prevent electrical shock in the event of an internal short circuit to the metal cabinet. The detachable line cord should be connected to the IEC320 connector on the power entry module.

4.5.4 Fuses

The correct fuses must be installed into the fuse holder that is part of the AC power entry module. Please check the fuse label on the rear panel, before installing new fuses (see Figure 33).



WARNING

To avoid electric shock, the appropriate fuses for the AC input power voltage must be installed in the instrument. Only qualified service personnel should replace fuses. Failure to observe these precautions can result in fire, severe injury or death.

4.5.5 TEC Output Connector

A DB-15 female D-connector is used for input and output connections, as shown by the pin out diagram below.

Pin	Description
1	TEC+
2	TEC+
3	TEC-
4	TEC-
5	TEC Shield
6	Sensor Shield
7	Sensor+
8	Sensor-
9	
10	
11	
12	
13	
14	
15	

Table 4 TEC Connector Pin-out

4.5.5.1 TEC Grounding Consideration

The TEC output is isolated from chassis ground, allowing either output terminal (TE+ or TE-) to be connected to Earth Ground at the user's option.

	<p>CAUTION</p> <p>Do not connect the temperature sensor to Earth Ground at the same time with grounding either TE+ or TE-. Only one connection to ground is accepted. Failure to do so may result in the unit malfunction or/and damage. Be careful when connecting other instruments to 6100 Laser Diode and Temperature Controller, as they may have their ground connected to the Earth Ground.</p> <p>For example, oscilloscopes have the probe ground connected to Earth Ground. If either TE+ or TE- is already connected to Earth Ground, the oscilloscope may bring the second connection, causing malfunction or damage.</p>
---	--

4.5.6 Laser Diode Output Connector

A DB-9 female D-connector is used for input and output connections, as shown by the pin out diagram below.

Pin	Description
1	Interlock
2	Interlock Return
3	Chassis Ground
4	Laser Diode Cathode
5	Laser Diode Cathode
6	Photodiode Cathode
7	Photodiode Anode
8	Laser Diode Anode
9	Laser Diode Anode

Table 5 Laser Diode Connector Pin-out

4.5.6.1 Laser Diode Grounding Consideration

The Laser Diode output is isolated from chassis ground, allowing either output terminal (Laser Diode Anode or Laser Diode Cathode) to be connected to Earth Ground at the user's option. Furthermore, the Laser Diode subsystem outputs are isolated from the Temperature Controller subsystem outputs; a single ground connection can be made for each.

	<h3>CAUTION</h3> <p>Do not connect the temperature sensor to Earth Ground at the same time with grounding either TE+ or TE-. Only one connection to ground is accepted. Failure to do so may result in the unit malfunction or/and damage. Be careful when connecting other instruments to 6100 Laser Diode and Temperature Controller, as they may have their ground connected to the Earth Ground.</p> <p>For example, oscilloscopes have the probe ground connected to Earth Ground. If either TE+ or TE- is already connected to Earth Ground, the oscilloscope may bring the second connection, causing malfunction or damage.</p>
---	---

4.5.7 I/O Signals Connector

This female 25 pin D-connector provides access to various analog and digital input/output signals. The signal pin assignments for this connector are shown in Table 6, below. Detailed information on these signals is provided in Section 4.6.

Pin No.	Name	Descriptions
1	Fault Output	+5V TTL-Level Output
2	TTL Input	General Input. +5V (Digital) Pull Up
3	TTL Output	General Output. +5V TTL-Level Output
4	LDD Current Monitor (Output)	Differential Analog signal proportional to LDD output current. Level 0-10V (into 10K load)
5	LDD Voltage Monitor (Output)	Differential Analog signal equal to the compliance voltage. Level 0-Max Compliance Voltage (into 10K load)
6	Analog Control (Input)	Differential Analog signal. MPU sampled LD current setpoint command. Level 0 - 10V Analog, 10Hz (max) input. Requires USB command to activate.
7	LD Anode Sense (Input)	Differential Analog Input. Monitors LD voltage. Works in conjunction with pin 20.
8	Chassis Ground	Chassis Ground
9	<i>reserved</i>	
10	<i>reserved</i>	
11	<i>reserved</i>	
12	<i>reserved</i>	
13	<i>reserved</i>	
14	Fault Output Return	Digital Ground
15	TTL Input Return	Digital Ground
16	TTL Output Return	Digital Ground
17	LDD Current Monitor Output (Return)	Differential Analog Output.
18	LDD Voltage Monitor Output (Return)	Differential Analog Output.
19	Analog Control Input (Return)	Differential Analog Input.
20	LD Cathode Sense (Input)	Differential Analog Input. Monitors LD voltage. Works in conjunction with pin 7.
21	<i>reserved</i>	
22	<i>reserved</i>	
23	<i>reserved</i>	
24	<i>reserved</i>	
25	<i>reserved</i>	

Table 6 I/O Signals Connector Pin Assignments

4.6 Signals I/O

The rear panel SIGNALS I/O connector provides several signals for remotely controlling and monitoring the Model 6100 Laser Diode and Temperature Controller.

There are four different grounds – the Chassis Ground, the Digital Ground, the Laser Diode Analog Ground, and the Temperature Controller Analog Ground. The Laser Diode Analog Ground, Temperature Controller Analog Ground, and the Digital Ground are isolated from each other within the Model 6100.

The Chassis Ground is also isolated from the other three grounds. The Chassis Ground and Digital Ground are available to the user on the back panel DB-25 female connector. Although it is not required, these grounds may be connected together externally provided ground loops are not introduced. Such ground loops will degrade the performance of the unit. Because the USB interface is referenced to digital ground, users should be especially careful not to introduce a ground loop through an externally-connected computer, which usually connect the Digital Ground to Chassis Ground.

The best approach is to have the chassis ground connected in one single point in a system so that currents between the grounds are avoided.

	CAUTION Cables and wires connected to the Model 6100's SIGNALS I/O connector must be fully shielded. The shield must be connected to the shell of the mating connector. Failure to do so may reduce the immunity of the Model 6100 to external electrical and magnetic fields and thereby damage an attached laser diode.
---	--

4.6.1 Fault

The Fault signal is a TTL-Level output referenced to the unit's Digital Ground. When a fault condition is detected, the unit will internally pull this signal to about +5V using a 10 Kohm resistor. When a fault condition is not detected, the unit will sink up to 8 mA to Digital Ground. For convenience, digital ground is located at pin 14 of the same connector.

4.6.2 TTL Input

The TTL Input signal is a TTL-Level input referenced to the unit's Digital Ground. The signal is internally pulled to about +5V via a 680 Ω resistor in series with the photodiode of an optical isolator integrated circuit. This is a general purpose input which can be monitored via software (see TEC:TTL:IN? command) and used for internal/external event synchronization. For convenience, digital ground is located at pin 15 of the same connector.

4.6.3 TTL Output

The TTL Output signal is a TTL-Level output referenced to the unit's Digital Ground. This signal is driven by an open-collector transistor output internally pulled to +5V via a 1 k Ohm resistor. This is a general purpose output which can be set via software (see TEC:TTL:OUT command) and used for internal/external event synchronization. For convenience, digital ground is located at pin 16 of the same connector.

4.6.4 LDD Current Monitor Output / Current Monitor Output (Return)

The LDD Current Monitor Output and LDD Current Monitor Output (Return) signals are a differential analog output loosely coupled to the unit's Laser Diode Analog Ground. These signals allow the user to monitor the Model 6100 Laser Diode Driver subsystem's output current using an oscilloscope or similar instrument. The output range is 0 to 10 V, which corresponds to the output current range of 0 to Maximum Current.

4.6.5 LDD Voltage Monitor Output / Voltage Monitor Output (Return)

The LDD Voltage Monitor Output and LDD Voltage Monitor Output (Return) signals are a differential analog output loosely coupled to the unit's Laser Diode Analog Ground. These signals allow the user to monitor the voltage across the user's laser diode using an oscilloscope or similar instrument. The default is to report the voltage at the Model 6100 Laser Diode Driver subsystem's output connector. Alternatively, the voltage across the LD Cathode Sense / LD Anode Sense signals will be reported if this has been previously selected by a command received via USB interface. The output range is 0 to the Maximum Compliance Voltage.

4.6.6 LD Cathode Sense / LD Anode Sense

The LD Cathode Sense and LD Anode Sense signals are a differential analog input loosely coupled to the unit's Laser Diode Analog Ground.

Normally, the unit will measure and monitor the voltage drop at the rear panel output connector using connections within the instrument, but this measurement will not reflect the actual voltage drop across the user's laser diode due to the voltage drop in the wiring between the unit and the user's laser diode.

The LD Cathode Sense and LD Anode Sense signals are provided so that the unit can measure and monitor the voltage drop across the laser diode. To select these signals for voltage sensing, rather than the Model 6100 Laser Diode subsystem connector pins, the unit must be commanded by an external

computer to select these signals via the USB interface. (See the HWCONFIG command in Section 5.5)

These signals may be left unconnected if they are not selected.

4.6.7 Analog Input / Analog Input (Return)

The Analog Input and Analog Input (Return) signals are a differential analog input loosely coupled to the unit's Laser Diode Analog Ground. This input allows the user to bring in a voltage signal (0 to 10 V) for monitoring by the instrument; the signal is sampled at 100Hz. LIV characterization is one of the typical applications where this input can be used. For this application, the analog input can be from an optical power meter representing a laser diode's optical power.

4.6.8 Chassis Ground

For convenience, the Model 6100 has a chassis ground connection on the I/O Signals connector.

This page is intentionally left blank

5 Computer Interfacing

5.1 General Guidelines

The Model 6100 Laser Diode and Temperature Controller has a USB interface to receive commands from, and send responses to, a host PC. The commands supported by the instrument can be divided into the following two categories: commands that cause it to take a desired action, and commands (queries) that cause it to return a stored value.

Query commands must end with a question mark (?). It is recommended that when a query command is sent, the response to that command from the instrument be read before issuing any other command.

Set commands, on the other hand, are used to configure/setup the instrument for a desired mode of operation. These commands take at least one parameter. The subsequent sections in this chapter detail the communication protocols supported by the instrument.

5.2 Computer Interface Terminology

Listed below are the key abbreviations and concepts used in the command reference section of this manual.

5.2.1 <...> Delimiting Punctuation

For the purposes of this manual, any string enclosed by <...> is considered to be a command, a string or numerical argument. The punctuation <...> is used to symbolize the typographic limits of the command, string or argument in question.

5.2.2 <CR> Carriage Return

The ASCII encoded byte 13 in decimal. (0D hex)

5.2.3 <LF> Line Feed

The ASCII encoded byte 10 in decimal. (0A hex)

5.2.4 (;) Semicolons

Semicolons are used to separate commands within a single transmission (concatenation).

5.2.5 Command Termination

All the commands sent to the driver must be terminated by a <CR><LF> sequence.

5.2.6 Response Termination

All the responses from the driver are terminated by a <CR><LF> sequence.

5.3 Controller Operation Mode

The Temperature Controller supports two modes of operation: LOCAL and REMOTE. The instrument will be in LOCAL mode, by default, following a power reset. In this mode, setpoint and output current limit values can be adjusted by turning the knob on front panel of the instrument. Output can be turned ON and OFF by pressing the output switch. Please refer the “System Operation” chapter for a detailed description on how to accomplish these tasks. When it is in REMOTE mode, knob control is disabled; setpoint and other settings can be adjusted only by issuing appropriate commands from a host PC. The REMOTE or LOCAL status indicator character can be found in the LCD display.

By default, the instrument enters REMOTE mode when it receives any command through USB communication interface. It can be setup to enter this state on any set command only by setting the appropriate bit in configuration register (refer “HWCONFIG” command). The instrument can be put back in LOCAL mode by issuing “LOCAL” command.

5.4 USB Communication

The instrument is designed to communicate with a host PC via a standard USB interface. Before connecting the instrument to the USB interface the user should install the application included in the software CD that accompanies the Temperature Controller. The application automatically installs the right USB drivers. Communication can be done through this interface by using the application or by developing software in the user’s preferred programming language. The software CD contains communication drivers and example programs in the following programming languages: LabVIEW and C#.NET

5.5 Commands and Queries

There are two types of device commands: commands that cause the instrument to take a desired action, and queries that return a stored value or state of the instrument. Queries must end with a question mark (?), while commands may require parameter(s) to follow:

TEC:LIMit:Ite 10.00

For example, the value "10.00" in the command **TEC:LIMit:Ite 50.00** sets the output current limit at 10.00. The command/query **MUST** contain all of the letters shown in upper-case; lower-case letters in the commands are optional, and may be used for clarity.

The commands may be sent to the instrument in either upper or lower case or in any combination. For example, the following commands are equal:

TEC:LIMit:ITE 10.00

TEC:LIM:ITE 10.00

tec:LIM:ITE 10.00

Tec:Lim:Ite 10.00

COMMAND EXECUTION:

The controller interprets the commands in the order they are received and executes them sequentially. If a set of commands have to be executed closer to each other, these commands can be sent to the controller simultaneously by creating a command string with semicolon (;) used as a command separator. The command string length should not exceed 50 characters. In the example shown below, a command string was created with semicolon separating 5 queries. The controller responds to this command string with a response that has 5 values using a comma (,) as a separator.

COMMAND STRING:

TEC:OUT?;TEC:SET:I?;TEC:ITE?;TEC:VTE?

INSTRUMENT RESPONSE:

0, 5.0,0.0,0.00

COMMAND TERMINATION:

All commands sent to the instrument must be terminated by <Carriage Return><Line Feed>.characters. All responses sent out by the instrument are terminated by the same characters.

Commands and Queries Summary Table

Command Syntax	Command Description	Remarks
*IDN?	Identification string query	
*RCL	Recall settings	Restore instrument to setup state stored in its non-volatile local memory
*RST	Reset instrument	
*SAV	Save instrument's settings	Save instrument's current settings in its non-volatile local memory
*STB?	Status Byte Query	Returns "error message available" status
ADDRess	Controller USB address set	
ADDRess?	Controller USB address query	
BEEP	Turns the beeper on or off, or beeps once	
BEEP?	Beeper status query	
BRIGHT	Display brightness set	
BRIGHT?	Display brightness query	
ERRors?	Error code query	
ERRSTR?	Error string query	
HWCONFIG	Hardware configuration set	
HWCONFIG?	Hardware configuration query	
LOCAL	Return to local mode	
LOCKOUT	Lockout the front panel	
LOCKOUT?	Front panel lockout state query	
ONDELAY	Output turn-on delay set	
ONDELAY?	Output turn-on delay query	
LASer:ANALOG:VOLT?	Measured analog input voltage query	
LASer:BW	LDD bandwidth set	
LASer:BW?	LDD bandwidth query	
LASer:CALMD (CALPD)	Laser photodiode responsivity set	
LASer:CALMD (CALPD)?	Laser photodiode responsivity query	
LASer:COND?	Laser condition query	
LASer:LDI (I)	Laser current set point	
LASer:LDI (I)?	Measured laser current query	
LASer:LDV?	Measured forward voltage query	
LASer:LIMit:LDI (I)	Laser output current limit set	
LASer:LIMit:LDI (I)?	Laser output current limit set query	
LASer:LIMit:LDV	Laser forward voltage limit set	
LASer:LIMit:LDV?	Laser forward voltage limit query	
LASer:LIMit:MDI (IPD)	Laser photodiode current limit set	
LASer:LIMit:MDI (IPD)?	Laser photodiode current limit set query	
LASer:LIMit:MDP (Ppd)	Laser photodiode power limit set	
LASer:LIMit:MDP (Ppd)?	Laser photodiode power limit set query	
LASer:LIV:COUNT?	LIV characterization samples query	
LASer:LIV:ENable	LIV characterization enable state set	
LASer:LIV:ENable?	LIV characterization enable state query	

LASer:LIV:GETMEAS?	LIV characterization get measurements	
LASer:LIV:SETUP	LIV characterization parameters setup	
LASer:LIV:SETUP?	LIV characterization parameters query	
LASer:MDI (IPD)	Laser photodiode current set point	
LASer:MDI (IPD)?	Measured photodiode current query	
LASer:MDP (Ppd)	Laser photodiode power set point	
LASer:MDP (Ppd)?	Measured photodiode power query	
LASer:MODE	LDD operation mode set	
LASer:MODE?	LDD operation mode query	
LASer:MODE:LDI (I)	Set Constant Current LDD operation mode	
LASer:MODE:MDI (IPD)	Set Constant Photodiode Current LDD operation mode	
LASer:MODE:MDP (Ppd)	Set Constant Photodiode Power LDD operation mode	
LASer:MODULATE	LDD modulation enable/disable	
LASer:MODULATE?	LDD modulation enable/disable query	
LASer:OUTput	Laser output enable/disable	
LASer:OUTput?	Laser output enable status query	
LASer:PDZERO:ENable	Photodiode feedback offset enable/disable	
LASer:PDZERO:ENable?	Photodiode feedback offset enable/disable query	
LASer:PDZERO:OFFSET	Photodiode feedback offset value set	
LASer:PDZERO:OFFSET?	Photodiode feedback offset query	
LASer:RAMP:LDI (I)	Sets the output current ramp parameters	
LASer:RAMP:LDI (I)?	Output current ramp parameters query	
LASer:RAMP:MDI (IPD)	Sets the photodiode current ramp parameters	
LASer:RAMP:MDI (IPD)?	Photodiode current ramp parameters query	
LASer:RANGE	LDD range set	
LASer:RANGE?	LDD range query	
LASer:SET:LDI (I)?	Laser current set point query	
LASer:SET:MDI (IPD)?	Laser photodiode current set point query	
LASer:SET:MDP (Ppd)?	Laser photodiode power set point query	
LASer:TTL:MODE	LDD TTL pulse out operation mode set	
LASer:TTL:MODE?	LDD TTL pulse out operation mode query	
LASer:TTL:IN?	LDD TTL input state query	
TEC:COND?	TEC condition register query	
TEC:CONST	TEC feedback sensor constants set	Select desired sensor before setting constants
TEC:CONST?	TEC feedback sensor constants query	
TEC:GAIN:IL	PID control – integral limit set	
TEC:GAIN:IL?	PID control – integral limit query	
TEC:GAIN:KD	PID control – derivative gain set	
TEC:GAIN:KD?	PID control – derivative gain query	
TEC:GAIN:KI	PID control – integral gain set	
TEC:GAIN:KI?	PID control – integral gain query	
TEC:GAIN:KP	PID control – proportional gain set	
TEC:GAIN:KP?	PID control – proportional gain query	

TEC:GAIN:PRESET	PID control – preset gains select	
TEC:GAIN:PRESET?	PID control – preset gains select query	
TEC:Ite	Output current setpoint	
TEC:Ite?	Measured output current query	
TEC:LIM:Ite	Output current limit set	
TEC:LIM:Ite?	Output current limit query	
TEC:LIM:RHI	High resistance limit set	
TEC:LIM:RHI?	High resistance limit query	
TEC:LIM:RLO	Low resistance limit set	
TEC:LIM:RLO?	Low resistance limit query	
TEC:LIM:THI	High temperature limit set	
TEC:LIM:THI?	High temperature limit query	
TEC:LIM:TLO	Low temperature limit set	
TEC:LIM:TLO?	Low temperature limit query	
TEC:LIM:Vte	Compliance voltage limit set	
TEC:LIM:Vte?	Compliance voltage limit query	
TEC:MODE	TEC operation mode set	
TEC:MODE?	TEC operation mode query	
TEC:MODE:Ite	Set operation mode to constant current	
TEC:MODE:R	Set operation mode to constant resistance/reference	
TEC:MODE:T	Set operation mode to constant temperature	
TEC:OUTput	TEC output enable/disable status set	
TEC:OUTput?	TEC output enable/disable status query	
TEC:R	Constant R (resistance/reference) setpoint	Select desired sensor before setting setpoint
TEC:R?	Measured R (resistance/reference) query	Select desired sensor before querying R value
TEC:SENsor	Feedback sensor type set	
TEC:SENsor?	Feedback sensor type query	
TEC:SET:Ite?	Constant current setpoint query	
TEC:SET:R?	Constant R (resistance/reference) setpoint query	Select desired sensor before querying setpoint
TEC:SET:T?	Constant temperature setpoint query	
TEC:T	Constant temperature setpoint	
TEC:T?	Measured temperature query	
TEC:THERM	Custom thermistor rating set	
TEC:THERM?	Custom thermistor rating query	
TEC:Vte?	Measured compliance voltage query	

Table 7 Command Summary

IDN?*Description** Identification string query.**Syntax** *IDN?**Remarks** This query will cause the instrument to return an identification string.

Model Name	Firmware Version #	Firmware Date	Controller Serial #
⏟	⏟	⏟	⏟

NEWPORT XXXX vYYY mm/dd/yy, SNZZZZ

RCL*Description** Recall command.**Syntax** *RCL *Bin*

Argument	Value	Description
<i>Bin</i>	0	Restores factory default settings
	1 to 5	Restores settings saved in specified bin

Remarks This command restores the instrument to the setup states saved in instrument's non-volatile flash memory. The parameters that can be restored are:

1. USB address
2. Beeper enable/disable state
3. LCD display brightness
4. Hardware configuration register value
5. Dial (rotary knob) lockout state
6. Measurement screen selection
7. TTL mode
8. Pulse mode
9. Pulse width
10. Pulse frequency
11. LDD mode of operation
12. LDD range
13. LDD bandwidth
14. LDD output enable delay period
15. LDD modulation enable state
16. LDD photodiode responsivity
17. LDD photodiode zero enable state
18. LDD photodiode zero offset value
19. LDD laser diode current setpoint
20. LDD photodiode current setpoint
21. LDD photodiode power setpoint
22. LDD laser diode current limit
23. LDD photodiode current limit
24. LDD photodiode power limit
25. LDD compliance voltage limit

26. LDD laser diode current ramp parameters
27. LDD photodiode current ramp parameters
28. TEC mode of operation
29. TEC feedback sensor type
30. TEC feedback sensor constants
31. TEC custom feedback thermistor value
32. TEC constant output current setpoint
33. TEC constant R (resistance/reference) setpoint
34. TEC constant temperature setpoint
35. TEC output current limit
36. TEC high resistance limit
37. TEC low resistance limit
38. TEC high temperature limit
39. TEC low temperature limit
40. TEC compliance voltage limit
41. PID control gains (proportional, integral and derivative) and integral limit

See Also *RST, *SAV

*RST

Description Reset command.

Syntax *RST

Remarks This command performs a soft reset of the instrument.

See Also *RCL

*SAV

Description Save command.

Syntax *SAV *Bin*

Argument	Value	Description
<i>Bin</i>	1 to 5	Saves current settings to specified bin

Remarks This command stores the current state of the instrument in non-volatile flash memory. This state is then recalled using the *RCL command. See description of *RCL command for a list of values saved/recalled by the instrument.

See Also *RCL

*STB?

Description Status Byte Register query.

Syntax *STB?

Remarks This query returns the Status Byte Register.

Response	Description
<i>Status Byte Register</i>	bit 0 Reserved
	bit 1 Reserved
	bit 2 Reserved
	bit 3 Reserved
	bit 4 Reserved
	bit 5 Reserved
	bit 6 Reserved
	bit 7 Error Message Available

ADDRESS

Description USB address command.

Syntax **ADDRESS** *Value*

Remarks This command sets the instrument USB address. After changing USB address, the communication with the instrument has to be re-initialized. This can be accomplished by calling “InitSystem” function in the DLL available in the CD provided with the instrument.

Argument	Value	Description
<i>Value</i>	0	Reserved
	1 to 31	Valid USB address range

See Also **ADDRESS?**

ADDRESS?

Description USB address query.

Syntax **ADDRESS?**

Remarks This query returns the instrument’s USB address.

Response	Description
<i>address</i>	USB address of instrument

See Also **ADDRESS**

BEEP

Description Beep command

Syntax **BEEP** *beep set*

Remarks This command controls the instrument’s beeper. The beeper is used to signal error or warning conditions.

Response	Value	Description
<i>beep set</i>	0	Beeper off

- 1 Beeper on
- 2 Test beeper (100ms beep)

See Also **BEEP?**

BEEP?

Description Beep query

Syntax **BEEP?**

Remarks This query returns the enable status of the beeper.

Response	Description
<i>beep set</i>	0 Beeper off
	1 Beeper on

See Also **BEEP**

BRIGHT

Description Display brightness command

Syntax **BRIGHT** *brightness*

Remarks This command controls the brightness of the controller display.

Argument	Value	Description
<i>brightness</i>	Integer	Brightness, in percentage, from 1% to 100%

See Also **BRIGHT?**

BRIGHT?

Description Display brightness query

Syntax **BRIGHT?**

Remarks This query returns the display brightness setting.

Response	Description
<i>brightness</i>	Display brightness, in percentage.

See Also **BRIGHT**

ERRors?

Description Error query.

Syntax **ERRors?**

Remarks This query returns a single error number that corresponds to an error occurred since the last query. This command also clears the read error from the error buffer. Refer to Appendix A for a list of error codes generated by the instrument

Response	Description
<i>Error code</i>	Error code number per Appendix A, 0 if no errors

See Also **ERRSTR?**

ERRSTR?

Description Error string query.

Syntax **ERRSTR?**

Remarks This query returns a single error code along with the corresponding error text string that occurred since the last error query. Refer to Appendix A for a list of error codes and strings generated by the instrument.

Response	Description
<i>Error code, "text"</i>	Error code and text for error code as per chapter, 0 if no errors

See Also **ERRors?**

HWCONFIG

Description Hardware configuration register command.

Syntax **HWCONFIG** *Value*

Remarks This command sets the hardware configuration register. Please refer the table below for a description of the various bits in this register.

Argument	Value	Description
<i>Value</i>	Integer	Valid values are between 0 and 255

Bit #	Meaning	Remarks
0	Remote mode	0* = switch to remote mode when any command is received over USB interface 1 = switch to remote mode only when any set command is received over USB interface Switching from remote to local mode is achieved when "LOCAL" command is received over USB interface
1	Ramp output current	0* = Ramp up output current from existing to new setpoint in remote mode 1 = Do not ramp up output current; just set the value
2	Reserved	
3	Reserved	
4	Reserved	
5	Laser Diode Forward voltage monitor	0* = The unit displays the voltage across the output terminals 1 = The unit displays the Laser Diode Anode to Cathode Sense voltage
6	Reserved	
7	Reserved	0* = Link LDD output enable state to TEC output enable state 1 = Do not link LDD output enable state to TEC output enable state

Table 8 HWCONFIG Register

* indicates factory default setting.

See Also **HWCONFIG?**

HWCONFIG?

Description Hardware configuration register query.

Syntax **HWCONFIG?**

Remarks This query returns the instrument's hardware configuration register.

Response	Description
-----------------	--------------------

<i>Value</i>	Hardware configuration register setting
--------------	---

See Also **HWCONFIG**

LOCAL

Description Return to local mode.

Syntax **LOCAL**

Remarks This command returns the instrument to local mode after being placed in remote mode by USB communication interface.

See Also **None**

LOCKOUT

Description Lockout the instrument front panel.

Syntax **LOCKOUT** *Value*

Remarks This command can be used to lockout all the buttons and dial knob or just the dial knob on the front panel.

Argument	Value	Description
<i>Value</i>	0	Front panel buttons and dial knob enabled
	1	Front panel buttons and dial knob disabled
	2	Front panel dial knob disabled

See Also **None**

LOCKOUT?

Description Instrument front panel lockout state query.

Syntax **LOCKOUT?**

Remarks This query returns the instrument's front panel lockout state.

Response	Description
-----------------	--------------------

<i>Value</i>	Front panel lockout state
--------------	---------------------------

See Also **LOCKOUT**

ONDELAY

Description Laser turn on delay command.

Syntax **ONDELAY** *time*

Remarks This command controls the laser turn on delay. This is the amount of time between the moment the laser on command is received and the moment the output is actually energized. This setting is also used when a laser is commanded to turn on by pushing the OUTPUT button on front panel of instrument when it is in local control mode.

Argument	Value	Description
<i>Time</i>	<i>Integer</i>	<i>Time, in milliseconds. Valid values are between 3000 and 60000</i>

See Also **ONDELAY?**, **LAS:OUT**, **LAS:OUT?**

ONDELAY?

Description Laser turn on delay query

Syntax **ONDELAY?**

Remarks This command returns the laser turn on delay time.

Response	Description
<i>Value</i>	<i>Time, in milliseconds</i>

See Also **ONDELAY**, **LAS:OUT**, **LAS:OUT?**

LASer:ANALOG:VOLT?

Description Analog monitor input voltage query.

Syntax **LASer:ANALOG:VOLT?**

Remarks This command returns the analog input voltage.

Response	Description
<i>Value</i>	<i>Input voltage, in Volts</i>

See Also **LASer:MODE**, **LASer:MODE?**

LASer:BW

Description LDD bandwidth set.

Syntax **LASer:BW** *Value*

Remarks The **LASer:BW** command sets the laser diode driver bandwidth.

Argument	Value	Description
<i>Value</i>	0	Low bandwidth
	1	High bandwidth

See Also **LASer:BW?**

LASer:BW?

Description LDD bandwidth query.

Syntax **LASer:BW?**

Remarks The **LASer:BW?** command returns the laser diode driver bandwidth.

Response	Value	Description
<i>Value</i>	0	Low bandwidth
	1	High bandwidth

See Also **LASer:BW**

LASer:CALMD (CALPD)

Description Laser photodiode feedback responsivity set.

Syntax **LASer:CALMD** *Value*

Remarks This command sets the laser's photodiode feedback responsivity. The value of this parameter is used to convert between photodiode current (MDI) and photodiode power (MDP) values.

Argument	Description
-----------------	--------------------

<i>Value</i>	<i>Responsivity, in $\mu\text{A}/\text{mW}$</i>
--------------	--

If the photodiode responsivity is set to zero when the laser diode driver is in Constant Photodiode Power mode, the instrument will automatically switch the mode to Constant Photodiode Current.

See Also **LASer:CALMD?**, **LASer:MODE**, **LASer:MODE?**

LASer:CALMD (CALPD)?

Description Laser photodiode feedback responsivity query.

Syntax **LASer:CALMD?**

Remarks This command returns the laser's photodiode feedback responsivity.

Response	Description
-----------------	--------------------

<i>Value</i>	<i>Responsivity, in $\mu\text{A}/\text{mW}$</i>
--------------	--

See Also **LASer:CALMD**, **LASer:MODE**, **LASer:MODE?**

LASer:COND?

Description Laser condition status register query.

Syntax LASer:COND?

Remarks This command returns the laser condition status register.

Response	Description
----------	-------------

<i>Value</i>	<i>Laser condition status</i>
--------------	-------------------------------

Bit #	Meaning	Remarks
0	Output soft current limit	0 = Limit not reached; 1 = Limit reached
1	Output soft voltage limit	0 = Limit not reached; 1 = Limit reached
2	Reserved	
3	Reserved	
4	Remote interlock	0 = Grounded; 1 = Floating
5	Output disabled due to current limit	0 = False; 1 = True
6	Output disabled due to forward voltage limit	0 = False; 1 = True
7	Output disabled due to open circuit condition	0 = False; 1 = True
8	Reserved	
9	Output disabled due to over temperature	0 = No fault; 1 = Output turned OFF due to internal temperature exceeding safe levels
10	Output current state	0 = Disabled; 1 = Enabled
11	Output current enable delay timer (3 sec)	0 = Expired; 1 = Not Expired
12	Output current ramp state	0 = Steady (output current is at desired setpoint) 1 = Ramping
13	Reserved	
14	Reserved	
15	Reserved	

See Also LASer:MODE, LASer:MODE?

LASer:LDI (I)

Description Laser current set point command.

Syntax LASer:LDI *current set point*

Remarks This command sets the laser's constant laser diode current set point. This setpoint is used only when the LDD is in Constant Current (LDI) mode.

Argument	Value	Description
<i>current set point</i>	<i>Float</i>	<i>Laser driver output in mA. Valid values are between 0 and current rating of the instrument.</i>

See Also LASer:LDI?, LASer:SET:LDI?

LASer:LDI (I)?

Description Measured laser diode current query.

Syntax LASer:LDI (I)?

Remarks The LASer:LDI? query returns the value of the measured laser diode current.

Response	Description
<i>measured current</i>	<i>Measured laser diode current in mA</i>

See Also LASer:LDI, LASer:SET:LDI?

LASer:LDV?

Description Measured forward voltage query.

Syntax LASer:LDV?

Remarks The LASer:LDV? query returns the measured forward voltage.

If bit #5 in hardware configuration register is set to 0, this command returns the voltage at the output terminals of the instrument. If this bit is set to 1, this command returns the load voltage present at anode/cathode sense inputs of DB-25 pin I/O signals connector.

Response	Description
<i>measured voltage</i>	<i>Laser diode forward voltage in Volts</i>

See Also HWCONFIG, HWCONFIG?

LASer:LIMit:LDI (I)

Description Laser diode current limit set command.

Syntax LASer:LIMit:LDI *current limit*

Remarks The LASer:LIMit:LDI command sets the laser current limit value.

Argument	Value	Description
<i>current limit</i>	<i>Float</i>	<i>Current limit in mA. Valid values are between: 0 and 500 mA if instrument is in 500 mA range or 0 and 1500 mA if instrument is in 1500 mA range</i>

See Also **LASer:LIMit:LDI?**

LASer:LIMit:LDI (I)?

Description Laser diode current limit set query.

Syntax **LASer:LIMit:LDI?**

Remarks The **LASer:LIMit:LDI?** query returns the value of the laser diode current limit.

Response	Description
<i>current limit</i>	<i>Current limit in mA</i>

See Also **LASer:LIMit:LDI**

LASer:LIMit:LDV

Description Laser forward voltage limit set command.

Syntax **LASer:LIMit:LDV** *voltage limit*

Remarks The **LASer:LIMit:LDV** command sets the laser forward voltage limit value.

Argument	Value	Description
<i>voltage limit</i>	<i>Float</i>	<i>Voltage limit in Volts. Valid values are between 0 and 10 V.</i>

See Also **LASer:LIMit:LDV?**, **LASer:MAX:LDV?**

LASer:LIMit:LDV?

Description Laser forward voltage limit set query.

Syntax **LASer:LIMit:LDV?**

Remarks The **LASer:LIMit:LDV?** query returns the value of the laser diode forward voltage limit.

Response	Description
<i>voltage limit</i>	<i>Voltage limit in V</i>

See Also **LASer:LIMit:LDV**

LASer:LIMit:MDI (IPD)

Description Laser photodiode current limit set command.

Syntax **LASer:LIMit:MDI** *current limit*

Remarks The **LASer:LIMit:MDI** command sets the laser photodiode current limit value.

Argument	Value	Description
<i>current limit</i>	<i>Float</i>	<i>Current limit in μA. Valid values are between: 0 and 5000 μA</i>

See Also LASer:LIMit:MDI?

LASer:LIMit:MDI (IPD)?

Description Laser photodiode current limit set query.

Syntax LASer:LIMit:MDI?

Remarks The LASer:LIMit:MDI? query returns the value of the laser photodiode current limit.

Response	Description
<i>current limit</i>	<i>Current limit in μA</i>

See Also LASer:LIMit:MDI

LASer:LIMit:MDP (Ppd)

Description Laser photodiode power limit set command.

Syntax LASer:LIMit:MDP power limit

Remarks The LASer:LIMit:MDP command sets the laser photodiode power limit value. Please make sure that the photodiode responsivity is set to a value greater than 0 $\mu\text{A}/\text{mW}$ before specifying this parameter.

Argument	Value	Description
<i>power limit</i>	<i>Float</i>	<i>Power limit in mW. Valid values are between: 0 and (5000 μA / user specified photodiode responsivity)</i>

See Also LASer:LIMit:MDP?, LASer:CALMD

LASer:LIMit:MDP (Ppd)?

Description Laser photodiode power limit set query.

Syntax LASer:LIMit:MDP?

Remarks The LASer:LIMit:MDP? query returns the value of the laser photodiode power limit.

Response	Description
<i>power limit</i>	<i>Power limit in mW</i>

See Also LASer:LIMit:MDP

LASer:LIV:COUNT?

Description LIV characterization samples query.

Syntax LASer:LIV:COUNT?

Remarks The LASer:LIV:COUNT? query returns the number of measurements taken since the last time LIV characterization was enabled. Each measurement set consists of laser current setpoint, measured laser current, forward voltage and analog monitor input voltage values.

See Also LASer:LIV:SETUP, LASer:LIV:ENable, LASer:LIV:GETMEAS?

LASer:LIV:Enable

Description LIV characterization enable state set.

Syntax LASer:LIV:ENable *enable state*

Remarks The LASer:LIV:ENable command turns the LIV characterization process ON or OFF. Please make sure the LDD is set to Constant Current (LDI) mode before enabling the LIV process.

Argument	Value	Description
<i>enable</i>	0	OFF
	1	ON

See Also LASer:LIV:SETUP, LASer:LIV:COUNT?, LASer:LIV:GETMEAS?

LASer:LIV:ENable?

Description LIV characterization enable state query.

Syntax LASer:LIV:ENable?

Remarks The LASer:LIV:ENable? query returns the status of LIV characterization process.

Response	Value	Description
<i>enable</i>	0	OFF
	1	ON

See Also LASer:LIV:SETUP, LASer:LIV:COUNT?, LASer:LIV:GETMEAS?

LASer:LIV:GETMEAS?

Description Get LIV characterization measurements.

Syntax LASer:LIV:GETMEAS?

Remarks The **LASer:LIV:GETMEAS?** query returns the measurements taken since the last time the LIV characterization process was enabled. Each measurement set consists of four comma delimited values: laser current setpoint, measured laser current, forward voltage, and analog monitor input voltage.

When the instrument receives this command from a host PC, it attempts to transfer all measurements taken to the PC. The instrument expects a PC based application to read all the measurements before sending any new commands to it. Each measurement set is terminated by the response terminator (<CR><LF>), while an “End of data” string is used to signify the transfer of all measurements. The instrument sends a “No new data” string in case the PC attempts to read measurements faster than they were commanded to be taken.

See Also **LASer:LIV:SETUP**, **LASer:LIV:ENable**, **LASer:LIV:GETMEAS?**

LASer:LIV:SETUP

Description LIV characterization parameters setup.

Syntax **LASer:LIV:SETUP** *nn1,nn2,nn3,nn4*

Remarks The **LASer:LIV:SETUP** command sets the LIV characterization parameters. When the LIV characterization process is turned ON, the instrument increases/decreases the output current based on these setup parameters. The start current, end current and desired number of measurements are used to determine the current step size. The output current is increased/decreased by the above determined step size, at the beginning of every dwell time period. A new measurement is performed at the end of each dwell period. The LIV characterization process is turned OFF automatically once all the measurements have been collected.

Note that the laser current ramp feature is suspended during LIV characterization process.

Argument	Value	Description
<i>nn1</i>	<i>Float</i>	<i>Start current in Amps. Valid values are between 0 and current rating of the instrument.</i>
<i>nn2</i>	<i>Float</i>	<i>End current in Amps. Valid values are between 0 and current rating of the instrument.</i>
<i>nn3</i>	<i>Integer</i>	<i>Number of measurements to be taken. Valid values are between 1 and 100.</i>
<i>nn4</i>	<i>Integer</i>	<i>Dwell time (ms) before taking a new measurement. Valid values are between 10 and 60000 milli-seconds.</i>

See Also **LASer:LIV:COUNT?**, **LASer:LIV:ENable**, **LASer:LIV:GETMEAS?**

LASer:LIV:SETUP?

Description LIV characterization parameters query.

Syntax **LASer:LIV:SETUP?**

Remarks The **LASer:LIV:SETUP?** query returns the LIV characterization parameters.

Response	Description
<i>Start current</i>	<i>Start current in Amps</i>
<i>End current</i>	<i>End current in Amps</i>
<i>Number of measurements</i>	
<i>Dwell Time</i>	<i>Dwell time in milli-seconds</i>

See Also **LASer:LIV:COUNT?**, **LASer:LIV:ENable**, **LASer:LIV:GETMEAS?**

LASer:MDI (IPD)

Description Photodiode current set point command.

Syntax **LASer:MDI** *current set point*

Remarks This command sets the laser's constant photodiode current set point. This setpoint is used only when the LDD is in Constant Photodiode Current (MDI) mode. If a non-zero photodiode zero offset value is specified, and zero offset is enabled, the actual setpoint equals *current setpoint* plus photodiode zero offset value.

Argument	Value	Description
<i>current set point</i>	<i>Float</i>	<i>Photodiode current setpoint in μA. Valid values are between 0 and 5000 μA.</i>

See Also **LASer:MDI?**, **LASer:SET:MDI?**

LASer:MDI (IPD)?

Description Measured photodiode current query.

Syntax **LASer:MDI (IPD)?**

Remarks The **LASer:MDI?** query returns the value of the measured photodiode current. If a non-zero photodiode zero offset value is specified, and zero offset is enabled, the returned value equals measured photodiode current minus photodiode zero offset value.

Response	Description
<i>measured current</i>	<i>Measured photodiode current in μA</i>

See Also **LASer:LDI**, **LASer:SET:LDI?**, **LASer:PDZERO:ENable**, **LASer:PDZERO:OFFSET**

LASer:MDP (PPD)

Description Photodiode power set point command.

Syntax **LASer:MDP** *power set point*

Remarks This command sets the laser's constant photodiode power set point. This setpoint is used only when the LDD is in Constant Photodiode Power (MDP) mode. While this command provides users the convenience of specifying the setpoint in power units (mW), the actual setpoint used by the instrument is photodiode power * photodiode responsivity. If a non-zero photodiode zero offset value is specified, and zero offset is enabled, the actual setpoint equals (*power setpoint* * photodiode responsivity) plus photodiode zero offset value.

Argument	Value	Description
<i>power set point</i>	<i>Float</i>	<i>Photodiode power setpoint in mW. Valid values are between 0 and 5000 μA / photodiode responsivity.</i>

See Also LASer:MDP?, LASer:SET:MDP?

LASer:MDP (PPD)?

Description Measured photodiode power query.

Syntax LASer:MDP (PPD)?

Remarks The LASer:MDP? query returns the value of the measured photodiode power. If a non-zero photodiode zero offset value is specified, and zero offset is enabled, the returned value equals measured (photodiode current minus photodiode zero offset value) / photodiode responsivity.

Measured photodiode power = measured photodiode current / photodiode responsivity.

Response	Description
<i>measured power</i>	<i>Measured photodiode power in mW</i>

See Also LASer:MDP, LASer:SET:MDP?, LASer:PDZERO:ENable, LASer:PDZERO:OFFSET

LASer:MODE

Description Laser mode of operation command.

Syntax LASer:MODE *mode*

Remarks The LASer:MODE command selects the instrument's operation mode. If the mode is set to Constant Photodiode Power when the photodiode responsivity is zero, the instrument will automatically switch the mode to Constant Photodiode Current.

Argument	Value	Description
<i>mode</i>	<i>0</i>	<i>constant current mode (LDI)</i>
	<i>1</i>	<i>constant photodiode current (MDI)</i>
	<i>2</i>	<i>constant photodiode power (MDP)</i>

See Also LASer:MODE?

LASer:MODE?

Description	Laser operation mode query.
Syntax	LASer:MODE?
Remarks	The LASer:MODE? query returns the selected laser operation mode.
See Also	LASer:MODE

LASer:MODE:LDI (I)

Description	Enter Constant Current mode.
Syntax	LASer:MODE:LDI
Remarks	The LASer:MODE:LDI command sets the instrument to Constant Current mode.
See Also	LASer:MODE

LASer:MODE:MDI (IPD)

Description	Enter Constant Photodiode Current mode.
Syntax	LASer:MODE:MDI
Remarks	The LASer:MODE:MDI command sets the instrument to Constant Photodiode Current mode.
See Also	LASer:MODE

LASer:MODE:MDP (Ppd)

Description	Enter Constant Photodiode Power mode.
Syntax	LASer:MODE:LDI
Remarks	The LASer:MODE:LDI command sets the instrument to Constant Photodiode Power mode. If this command is sent when the photodiode responsivity is zero, the instrument will automatically switch the mode to Constant Photodiode Current.
See Also	LASer:MODE

LASer:MODULATE

Description	LDD modulation enable/disable set.
Syntax	LASer:MODULATE <i>Value</i>

Remarks The **LASer: MODULATE** command sets the laser diode driver modulation enable/disable state.

Argument	Value	Description
<i>Value</i>	0	OFF
	1	ON

See Also **LASer:MODULATE?**

LASer:MODULATE?

Description LDD modulation enable/disable query.

Syntax **LASer: MODULATE?**

Remarks The **LASer: MODULATE?** command returns the laser diode driver modulation enable/disable state.

Response	Value	Description
<i>Value</i>	0	OFF
	1	ON

See Also **LASer:MODULATE**

LASer:OUTput

Description Laser enable output command.

Syntax **LASer:OUTput** *enable*

Remarks The **LASer:OUTput** command turns the laser output on or off. When the output enable state is changed from OFF to ON, the output will only be enabled after the expiration of on-delay timer.

Argument	Value	Description
<i>enable</i>	0	off
	1	on

See Also **LASer:OUTput?, ONDELAY**

LASer:OUTput?

Description Laser enable output query.

Syntax **LASer:OUTput?**

Remarks The **LASer:OUTput?** query returns the status of the laser output.

Response	Value	Description
<i>enable</i>	0	off
	1	on

See Also **LASer:OUTput**

LASer:PDZERO:ENable

Description Photodiode current zero offset enable command.

Syntax **LASer:PDZERO:ENable** *enable*

Remarks This command is used to enable/disable a previously specified photodiode zero offset value.

Argument	Value	Description
<i>enable</i>	0	off
	1	on

See Also **LASer:PDZERO:ENable?**

LASer:PDZERO:ENable?

Description Photodiode current zero offset enable query.

Syntax **LASer:PDZERO:ENable?**

Remarks The **LASer: PDZERO:ENable?** query returns the enable status of photodiode zero offset value.

Response	Value	Description
<i>enable</i>	0	off
	1	on

See Also **LASer:PDZERO:ENable**

LASer: PDZERO:OFFSET

Description Photodiode feedback zero set point command.

Syntax **LASer:PDZERO:OFFSET** *offset*

Remarks This command sets the laser's photodiode feedback zero offset value.

Argument	Value	Description
<i>offset</i>	<i>Float</i>	<i>Photodiode zero offset in μA. Valid values are between 0 and 5000 μA</i>

See Also **LASer:PDZERO:OFFSET?**

LASer:MDP (PPD)?

Description Photodiode feedback zero offset query.

Syntax LASer:PDZERO:OFFSET?

Remarks The LASer: PDZERO:OFFSET? query returns the laser's photodiode feedback zero offset value.

Response	Description
<i>offset</i>	<i>Photodiode zero offset in μA</i>

See Also LASer:PDZERO:OFFSET

LASer:RAMP:LDI (I)

Description Laser current ramp settings command.

Syntax LASer:RAMP:LDI *step size, delay*

Remarks Sets the laser's current ramp settings. If bit #1 in hardware configuration register is cleared (default), the output current is ramped up from the present current set point to the new set point based on these settings. If this bit is set or if the new set point is lower than the present set point, no current ramping is performed. These settings are active only when the instrument is in Constant Current mode.

The default settings are: step size = 100 mA and delay = 100 msec.

Argument	Value	Description
<i>step size</i>	<i>Float</i>	<i>Step size in mA. Valid values are between 0.01 and 1500 mA.</i>
<i>delay</i>	<i>Integer</i>	<i>Delay in seconds. Valid values are between 1 and 3600000 msec.</i>

See Also LASer:RAMP:LDI?, HWCONFIG, HWCONFIG?

LASer:RAMP:LDI (I)?

Description Laser current ramp settings query.

Syntax LASer:RAMP:LDI?

Remarks The LASer:RAMP:LDI? query returns the laser current ramp settings.

Response	Description
<i>step size</i>	<i>Step size in mA.</i>
<i>delay</i>	<i>Delay in msec.</i>

See Also LASer:RAMP:LDI, HWCONFIG, HWCONFIG?

LASer:RAMP:MDI (IPD)

Description Laser current ramp settings command.

Syntax LASer:RAMP:MDI *step size, delay*

Remarks Sets the laser's current ramp settings. If bit #1 in hardware configuration register is cleared (default), the output current is ramped up from the present current set point to the new set point based on these settings. If this bit is set or if the new set point is lower than the present set point, no current ramping is performed. These settings are active when the instrument is in either Constant Photodiode Current or Photodiode Power modes.

The default settings are: step size = 10 μ A and delay = 100 msec.

Argument	Value	Description
<i>step size</i>	<i>Float</i>	<i>Step size in μA. Valid values are between 1 and 5000 μA.</i>
<i>delay</i>	<i>Integer</i>	<i>Delay in seconds. Valid values are between 1 and 3600000 msec.</i>

See Also LASer:RAMP:MDI?, HWCONFIG, HWCONFIG?

LASer:RAMP:MDI (IPD)?

Description Laser photodiode current ramp settings query.

Syntax LASer:RAMP:MDI?

Remarks The LASer:RAMP:MDI? query returns the laser photodiode current ramp settings.

Response	Description
<i>step size</i>	<i>Step size in μA.</i>
<i>delay</i>	<i>Delay in msec.</i>

See Also LASer:RAMP:MDI, HWCONFIG, HWCONFIG?

LASer:RANGE

Description LDD range set.

Syntax LASer:RANGE *Value*

Remarks The LASer:RANGE command sets the laser diode driver range.

Argument	Value	Description
<i>Value</i>	0	500 mA range
	1	1500 mA range

See Also LASer:RANGE?

LASer:RANGE?

Description LDD bandwidth query.

Syntax LASer:RANGE?

Remarks The LASer:RANGE? command returns the laser diode driver range.

Response	Value	Description
<i>Value</i>	0	500 mA range
	1	1500 mA range

See Also LASer:RANGE

LASer:SET:LDI (I)?

Description Laser constant current set point query.

Syntax LASer:SET:LDI?

Remarks The LASer:SET:LDI? query returns the constant current set point.

Response	Description
<i>set point</i>	<i>Current set point in mA</i>

See Also LASer:LDI

LASer:SET:MDI (IPD)?

Description Laser constant photodiode current set point query.

Syntax LASer:SET:MDI?

Remarks The LASer:SET:MDI? query returns the constant photodiode current set point.

Response	Description
<i>set point</i>	<i>Photodiode current set point in μA</i>

See Also LASer:MDI

LASer:SET:MDP (Ppd)?

Description Laser constant photodiode power set point query.

Syntax LASer:SET:MDP?

Remarks The LASer:SET:MDP? query returns the constant photodiode power set point.

Response	Description
<i>set point</i>	<i>Photodiode power set point in mW</i>

See Also **LASer:MDP**

LASer:TTL:MODE

Description Laser TTL pulse output mode of operation command.

Syntax **LASer:TTL:MODE** *mode*

Remarks The **LASer:TTL:MODE** command selects the instrument's TTL pulse output operation mode. The instrument always returns to "enable output" following a power reset.

Argument	Value	Description
<i>mode</i>	0	<i>output LOW</i>
	1	<i>output HIGH</i>
	2	<i>LDD enable output</i>
	3	<i>pulse signal monitor</i>
	4	<i>track TTL IN</i>
	5	<i>TEC enable output</i>

See Also **LASer:TTL:MODE?**

LASer:TTL:MODE?

Description Laser TTL pulse output operation mode query.

Syntax **LASer:TTL:MODE?**

Remarks The **LASer:TTL:MODE?** query returns the selected laser TTL pulse output operation mode.

See Also **LASer:TTL:MODE**

LASer:TTL:IN?

Description TTL input state query.

Syntax **LASer:TTL:IN?**

Remarks This query returns the TTL input state.

Response	Description
<i>value</i>	0 or 1 depending upon whether the TTL input is LOW or HIGH

See Also **TEC:TTL:OUT**

TEC:COND?**Description** TEC condition status register query.**Syntax** TEC:COND?**Remarks** This command returns the TEC condition status register.**Response Description***Value* TEC condition status

Bit #	Meaning	Remarks
0	Output soft current limit	0 = Limit not reached; 1 = Limit reached
1	Compliance voltage limit	0 = Limit not reached; 1 = Limit reached
2	Output disabled due to R/Temp limit	0 = Limit not reached; 1 = Limit reached
3	Reserved	
4	Reserved	
5	Reserved	
6	Output disabled due to over voltage	0 = No fault; 1 = Output turned OFF due to compliance voltage exceeding voltage rating
7	Output disabled due to open circuit	0 = No fault; 1 = Output turned OFF due to open circuit condition
8	Output disabled due to short circuit	0 = No fault; 1 = Output turned OFF due to short circuit condition
9	Output disabled due to over temperature	0 = No fault; 1 = Output turned OFF due to internal temperature exceeding safe levels
10	Output current state	0 = Disabled; 1 = Enabled
11	Reserved	
12	Reserved	
13	Reserved	
14	Reserved	
15	Reserved	

See Also TEC:MODE; TEC:MODE?

TEC:CONST**Description** TEC sensor constants command.**Syntax** TEC:CONST *C1* [, *C2* [, *C3* [, *Ro*]]]**Remarks** This command sets the TEC constants for the Steinhart-Hart equation for thermistors, slope and offsets for AD590s and LM335s, or the Callendar – van Dusen constants for RTDs.**Argument Description***For thermistors**C1* $\pm 9.999 \times 10^{-3}$ Steinhart-Hart constants

C2 $\pm 9.999 \times 10^{-4}$
C3 $\pm 9.999 \times 10^{-7}$

For LM335/AD590

C1 ± 9.999 °C Offset
C2 ± 9.999 Slope

For RTD

C1 $\pm 9.999 \times 10^{-3}$ RTD Temperature constants
C2 $\pm 9.999 \times 10^{-6}$
C3 $\pm 9.999 \times 10^{-12}$
Ro 95.000 to 105.000 Ω

If less than four parameters need to be changed, only the desired change needs to be specified, along with the separating commas (see examples).

When the LM335 or AD590 sensors are selected, only C1 and C2 are used. Therefore, only two parameters are required in those cases.

Examples **TEC:const 1.4**

Action: sets C1 to 1.400; C2, C3, and Ro remain unchanged.

TEC:CONST 1.4,2.015

Action: sets C1 to 1.400, C2 to 2.015 for two-point calibration of AD590 or LM335 sensors (C3 and Ro remain unchanged, but are not used).

See Also **TEC:CONST?**

TEC:CONST?

Description TEC sensor constants query.

Syntax **TEC:CONST?**

Remarks This query returns the TEC constants for the Steinhart-Hart equation for thermistors, slope and offsets for AD590s and LM335s, or RTD constants.

Response	Description
<i>C1</i>	See TEC:CONST for a description of these constants.
<i>C2</i>	
<i>C3</i>	
<i>Ro</i>	

When the LM335 or AD590 sensors are selected, only C1 and C2 are used. Therefore, C3 values may be ignored for these cases.

See Also **TEC:CONST**

TEC:GAIN:IL

Description PID control – integral limit.

Syntax **TEC:GAIN:IL** *Value*

Remarks This command limits the integral factor contribution to PID closed loop control. It is useful for preventing integral wind-up.

Argument	Value	Description
-----------------	--------------	--------------------

<i>Value</i>	Float	Integral limit
--------------	-------	----------------

See Also **TEC:GAIN:IL?; TEC:GAIN:KP; TEC:GAIN:KI; TEC:GAIN:KD**

TEC:GAIN:IL?

Description PID control – integral limit query.

Syntax **TEC:GAIN:IL?**

Remarks This query returns the integral limit value.

Response	Description
-----------------	--------------------

<i>Value</i>	Integral limit
--------------	----------------

See Also **TEC:GAIN:IL; TEC:GAIN:KP; TEC:GAIN:KI; TEC:GAIN:KD**

TEC:GAIN:KD

Description PID control – derivative gain factor.

Syntax **TEC:GAIN:KD** *Value*

Remarks This command sets the derivative gain factor, Kd, used in PID closed loop control.

Argument	Value	Description
-----------------	--------------	--------------------

<i>Value</i>	Float	Derivative gain factor
--------------	-------	------------------------

See Also **TEC:GAIN:KD?; TEC:GAIN:KP; TEC:GAIN:KI; TEC:GAIN:IL**

TEC:GAIN:KD?

Description PID control – derivative gain factor query.

Syntax **TEC:GAIN:KD?**

Remarks This query returns the derivative gain factor value.

Response	Description
-----------------	--------------------

<i>Value</i>	Derivative gain factor
--------------	------------------------

See Also **TEC:GAIN:KD; TEC:GAIN:KP; TEC:GAIN:KI; TEC:GAIN:IL**

TEC:GAIN:KI

Description PID control – integral gain factor.

Syntax **TEC:GAIN:KI** *Value*

Remarks This command sets the integral gain factor, Ki, used in PID closed loop control.

Argument	Value	Description
<i>Value</i>	Float	Integral gain factor

See Also **TEC:GAIN:KI?; TEC:GAIN:KP; TEC:GAIN:KD; TEC:GAIN:IL**

TEC:GAIN:KI?

Description PID control – integral gain factor query.

Syntax **TEC:GAIN:KI?**

Remarks This query returns the integral gain factor value.

Response	Description
<i>Value</i>	Integral gain factor

See Also **TEC:GAIN:KI; TEC:GAIN:KP; TEC:GAIN:KD; TEC:GAIN:IL**

TEC:GAIN:KP

Description PID control – proportional gain factor.

Syntax **TEC:GAIN:KP** *Value*

Remarks This command sets the proportional gain factor, Kp, used in PID closed loop control.

Argument	Value	Description
<i>Value</i>	Float	Proportional gain factor

See Also **TEC:GAIN:KP?; TEC:GAIN:KI; TEC:GAIN:KD; TEC:GAIN:IL**

TEC:GAIN:KP?

Description PID control – proportional gain factor query.

Syntax **TEC:GAIN:KP?**

Remarks This query returns the proportional gain factor value.

Response	Description
<i>Value</i>	Proportional gain factor

See Also**TEC:GAIN:KP; TEC:GAIN:KI; TEC:GAIN:KD; TEC:GAIN:IL****TEC:GAIN:PRESET****Description** PID control – preset gains bin.**Syntax** **TEC:GAIN:PRESET** *Value*

Remarks The 6100 Laser Diode and Temperature Controller has 10 preset PID control loop settings. This command can be used to select any one of these settings. After issuing this command, the commands such as TEC:GAIN:KP?, TEC:GAIN:KD? etc. can be issued to query the actual PID control loop settings that come with the desired preset bin. While this command is used to select some predefined PID settings, it does not preclude the users from modifying the individual gain settings. If any one of the gain settings is different from the predefined settings, the instrument assumes that the preset bin is a “custom” bin (bin number = 10).

Argument	Value	Description
<i>Value</i>	0 to 9	PID preset bin number

See Also**TEC:GAIN:KP; TEC:GAIN:KI; TEC:GAIN:KD; TEC:GAIN:IL****TEC:GAIN:PRESET?****Description** PID control – preset gains bin query.**Syntax** **TEC:GAIN:PRESET?****Remarks** This query returns the PID preset bin number.

Response	Description
<i>Value</i>	PID preset bin number

See Also**TEC:GAIN:KP?; TEC:GAIN:KI?; TEC:GAIN:KD?; TEC:GAIN:IL?****TEC:Ite****Description** TEC I_{TE} set point command.**Syntax** **TEC:Ite** *set point***Remarks** This command sets the TEC control current set point.

Argument	Value	Description
<i>set point</i>	float	set point in Amps

See Also **TEC:ITE?, TEC:LIMit:ITE, TEC:SET:ITE?**

TEC:Ite?

Description TEC measured output current query.

Syntax **TEC:Ite?**

Remarks This query returns the value of the measured TEC output current.

Response	Description
<i>measured output</i>	Current in Amps

The TEC current is constantly measured and updated, regardless of the TEC mode of operation.

This measurement is updated approximately once every 10 milliseconds.

See Also **TEC:Ite**

TEC:LIMit:Ite

Description TEC I_{TE} current limit command

Syntax **TEC:LIMit:Ite** *limit*

Remarks This command sets the TEC ITE current limit value.

Argument	Value	Description
<i>limit</i>	float	Limit in Amps

The factory default current limit is 0 Amps.

See Also **TEC:ITE**

TEC:LIMit:Ite?

Description TEC I_{TE} current limit query

Syntax **TEC:LIMit:Ite?**

Remarks This query returns the value of the TEC current limit.

Response	Description
<i>limit</i>	Limit in Amps

See Also **TEC:LIMit:Ite**

TEC:LIMit:RHI

Description TEC R_{HI} limit command.

Syntax **TEC:LIMit:RHI** *limit*

Remarks This command sets the TEC sensor high resistance limit value.

Argument	Value	Description
<i>limit</i>	float	Thermistor limit in $k\Omega$ or AD590 limit in μA or LM335 limit in mV or RTD limit in Ω

See Also **TEC:LIMit:RHI?**, **TEC:R**

TEC:LIMit:RHI?

Description TEC R_{HI} limit query.

Syntax **TEC:LIMit:RHI?**

Remarks This query returns the TEC sensor high resistance limit value.

Response	Description
<i>limit</i>	Thermistor limit in $k\Omega$ or AD590 limit in μA or LM335 limit in mV or RTD limit in Ω

See Also **TEC:LIMit:RHI**

TEC:LIMit:RLO

Description TEC R_{LO} limit command.

Syntax **TEC:LIMit:RLO** *limit*

Remarks This command sets the TEC sensor low resistance limit value.

Argument	Value	Description
<i>limit</i>		Thermistor limit in $k\Omega$ or

AD590 limit in μA
 or
 LM335 limit in mV
 or
 RTD limit in Ω

See Also **TEC:LIMit:RLO?, TEC:R**

TEC:LIMit:RLO?

Description TEC R_{LO} limit query.

Syntax **TEC:LIMit:RLO?**

Remarks This query returns the TEC sensor low resistance limit value.

Response	Description
<i>limit</i>	Thermistor limit in $k\Omega$ or AD590 limit in μA or LM335 limit in mV or RTD limit in Ω

See Also **TEC:LIMit:RLO**

TEC:LIMit:THI

Description TEC T_{HI} limit command.

Syntax **TEC:LIMit:THI *limit***

Remarks This command sets the TEC sensor high temperature limit value.

Argument	Value	Description
<i>limit</i>	float	Limit in $^{\circ}\text{C}$, -100 to 240 (200 for LM335 and AD590)

See Also **TEC:LIMit:THI, TEC:T**

TEC:LIMit:THI?

Description TEC T_{HI} limit query

Syntax **TEC:LIMit:THI?**

Remarks This query returns the value of the TEC sensor high temperature limit.

Response	Description
<i>limit</i>	Limit in °C, -100 to 240 (200 for LM335 and AD590)

See Also **TEC:LIMit:THI**

TEC:LIMit:TLO

Description TEC T_{LO} limit command.

Syntax **TEC:LIMit:TLO** *limit*

Remarks This command sets the TEC sensor low temperature limit value.

Argument	Value	Description
<i>limit</i>	float	Limit in °C, -100 to 240 (200 for LM335 and AD590)

See Also **TEC:LIMit:TLO?**, **TEC:T**

TEC:LIMit:TLO?

Description TEC T_{LO} limit query

Syntax **TEC:LIMit:TLO?**

Remarks This query returns the value of the TEC sensor low temperature limit.

Response	Description
<i>limit</i>	Limit in °C, -100 to 240 (200 for LM335 and AD590)

See Also **TEC:LIMit:TLO**

TEC:LIMit:Vte

Description TEC V_{TE} limit command.

Syntax **TEC:LIMit:Vte** *limit*

Remarks This command sets the compliance voltage limit value.

Argument	Value	Description
<i>limit</i>	float	Voltage limit from 0 to 10.0V

See Also **TEC:LIMit:Vte?**, **TEC:Vte?**

TEC:LIMit:Vte?

Description TEC V_{TE} limit query

Syntax **TEC:LIMit:Vte?**

Remarks This query returns the compliance voltage limit value.

Response	Description
<i>limit</i>	Voltage limit from 0 to 10.0V

See Also **TEC:LIMit:Vte**

TEC:MODE

Description TEC operation mode command.

Syntax **TEC:MODE** *mode*

Remarks This command sets the TEC's mode of operation.

Argument	Value	Description
<i>mode</i>	0	constant current
	1	constant R
	2	constant T

See Also **TEC:MODE?; TEC:MODE:Ite; TEC:MODE:R; TEC:MODE:T**

TEC:MODE?

Description TEC control mode query.

Syntax **TEC:MODE?**

Remarks This query returns the selected TEC control mode.

Response	Value	Description
<i>mode</i>	0	constant current
	1	constant R
	2	constant T

See Also **TEC:MODE; TEC:MODE:Ite; TEC:MODE:R; TEC:MODE:T**

TEC:MODE:ITE

Description TEC ITE mode command.

Syntax **TEC:MODE:ITE**

Remarks This command selects TEC constant current mode.

Changing modes causes the output to be forced off, and the new mode's set point value will be displayed.

See Also **TEC:I; TEC:MODE?**

TEC:MODE:R

Description TEC R mode command.

Syntax **TEC:MODE:R**

Remarks This command selects TEC constant thermistor resistance/linear sensor reference mode.

Since sensor resistance (or linear sensor reference) is a function of temperature, this mode also controls the TEC output temperature, but it bypasses the use of the conversion constants for set point calculation. This allows finer control of temperature in cases where the sensor's temperature model (and therefore the constants) is not known.

Changing modes causes the output to be forced off, and the new mode's set point value will be displayed.

See Also **TEC:MODE?**, **TEC:R**

TEC:MODE:T

Description TEC temperature mode command.

Syntax **TEC:MODE:T**

Remarks This command selects TEC constant temperature mode.

Since TEC temperature is derived from thermistor or RTD resistance, or, linear sensor current or voltage, constant R and T modes are related. In T mode the set point is converted to resistance voltage or current by using the appropriate constants and conversion model.

Changing modes causes the output to be forced off, and the new mode's set point value will be displayed.

See Also **TEC:MODE?**, **TEC:T**

TEC:OUTput

Description TEC output enable command.

Syntax **TEC:OUTput** *enable*

Remarks This command enables or disables the TEC output.

Argument	Value	Description
<i>enable</i>	0	off
	1	on

After the output is turned on, it may be useful to wait until the output is stable before performing further operations.

See Also **TEC:OUTput?**

TEC:OUTput?

Description TEC output enable query.

Syntax **TEC:OUTput?**

Remarks This query returns the status of the TEC output.

Response	Value	Description
<i>enable</i>	0	off
	1	on

Although the status of the switch is on, the output may not have reached the set point value.

See Also **TEC:OUTput**

TEC:R

Description TEC R set point command.

Syntax **TEC:R** *set point*

Remarks This command sets the TEC constant thermistor or RTD resistance or linear sensor voltage or current set point.

Argument	Value	Description
<i>set point</i>	float	Thermistor set point in k Ω or AD590 set point in μ A or LM335 set point in mV or RTD set point in Ω

See Also **TEC:LIMit:RHI; TEC:LIMit:RLO; TEC:R?**

TEC:R?

Description TEC measured R query.

Syntax **TEC:R?**

Remarks This query returns the value of the TEC thermistor or RTD resistance, AD590 current, or LM335 voltage measurement.

Response	Description
<i>R value</i>	Measured Thermistor resistance in k Ω

or
 Measured AD590 current in μA
 or
 Measured LM335 voltage in mV
 or
 Measured RTD resistance in Ω

This measurement is updated approximately once every 10 milliseconds.

See Also **TEC:R**

TEC:SENsor

Description TEC sensor select command.

Syntax **TEC:SENsor** *sensor*

Remarks This command is used to set the sensor type. This value is a coded representation of the sensor type/thermistor current.

Argument	Value	Description
<i>sensor</i>	0	None
	1	100 Ω Thermistor
	2	1.0k Ω Thermistor
	3	10.0k Ω Thermistor
	4	100.0k Ω Thermistor
	5	Reserved
	6	LM335
	7	AD590
	8	RTD
	9	Custom Thermistor

See Also **TEC:SENsor?**

TEC:SENsor?

Description TEC sensor select query.

Syntax **TEC:SENsor?**

Remarks This query returns the sensor type. This value is a coded representation of the sensor type/thermistor current.

Argument	Value	Description
<i>sensor</i>	0	None
	1	100 Ω Thermistor
	2	1.0k Ω Thermistor
	3	10.0k Ω Thermistor
	4	100.0k Ω Thermistor

5	Reserved
6	LM335
7	AD590
8	RTD
9	Custom Thermistor

See Also **TEC:SENsor**

TEC:SET:ITE?

Description TEC ITE set point query.

Syntax **TEC:SET:ITE?**

Remarks This query returns the TEC constant current set point value.

Response	Description
<i>set point</i>	ITE set point in Amps

See Also **TEC:I**

TEC:SET:R?

Description TEC R set point query.

Syntax **TEC:SET:R?**

Remarks This query returns the TEC constant thermistor or RTD resistance or linear sensor voltage or current set point value.

Response	Description
<i>set point</i>	Thermistor set point in k Ω or AD590 set point in μ A or LM335 set point in mV or RTD set point in Ω

See Also **TEC:R**

TEC:SET:T?

Description TEC temperature set point query.

Syntax **TEC:SET:T?**

Remarks This query returns the TEC constant temperature set point value in $^{\circ}$ C.

Response	Description
<i>set point</i>	Set point in $^{\circ}$ C

See Also **TEC:T**

TEC:T

Description TEC temperature set point command.

Syntax **TEC:T** *set point*

Remarks This command sets the TEC constant temperature set point.

Argument	Value	Description
<i>set point</i>	float	Set point in °C

See Also **TEC:SET:T?**, **TEC:T**

TEC:T?

Description TEC measured temperature query.

Syntax **TEC:T?**

Remarks This query returns the value of the TEC temperature measurement.

Response	Description
<i>measured temp</i>	Measured temperature in °C

This measurement is updated approximately once every 10 milliseconds.

See Also **TEC:T**

TEC:THERM

Description Custom thermistor feedback sensor rating.

Syntax **TEC:THERM** *rating*

Remarks This command sets the custom thermistor feedback sensor rating. This information is used by the instrument, in conjunction with thermistor constants, to arrive at temperature sensed by the custom thermistor.

Argument	Value	Description
<i>rating</i>	float	resistance in kΩ

See Also **TEC:THERM?**; **TEC:CONST**

TEC:THERM?

Description Custom thermistor feedback sensor rating query.

Syntax **TEC:THERM?**

Remarks This query returns the custom thermistor feedback sensor rating.

Response	Description
<i>rating</i>	resistance in k Ω

See Also **TEC:THERM**

TEC:Vte?

Description TEC compliance voltage query

Syntax **TEC:V?**

Remarks This query returns the TEC compliance voltage.

Response	Description
<i>voltage</i>	TEC voltage in volts

See Also **TEC:I?**

6 Principles of Operation

6.1 Introduction

Features of the Model 6100 Laser Diode and Temperature Controller include:

- High-stability, low noise design
- Fault detection
- Current, voltage and temperature limiting



CAUTION

Although ESD (electrostatic discharge) protection is designed into the driver, operation in a static-free work area is recommended.

6.2 TEC and Laser Diode Handling Precautions

TEC and Laser Diodes are sensitive to static discharge and guidelines should be followed at all times when handling laser diodes:

All operators must have a properly grounded wrist strap before handling any TEC.

All soldering iron tips must be properly grounded.

All related test and assembly equipment must be properly grounded

NOTE

Always follow the Laser Diode and TEC manufacturers' specifications for maximum temperatures and current.

**CAUTION**

Before connecting the TEC or Laser Diode to the Model 6100, be sure that the outputs are both OFF. Before turning on a TEC or Laser Diode output, be sure that the current limits and voltage compliance limits has been correctly set.

NOTE

The cable connections to the TEC and / or Laser Diode must be secure to avoid an open circuit, should they be jostled or bumped. Should an open circuit occur during operation, the output current will normally be turned off automatically.

NOTE

Special circuits in the TEC and Laser Diode drivers are present for detecting intermittent contacts and connections. These circuits detect the abrupt change in current that occurs when the output circuit is opened, and the model 6100 will generate an error.

Electrostatic discharge (ESD) can cause TEC or Laser Diode failure. In order to optimize immunity from radiated or conducted electromagnetic energy, e.g., static discharge, adhere to the following guidelines for the TEC:

- Use anti-static wrist straps (grounded with 1 M Ω resistor), anti-static floor coverings, grounded soldering irons, and grounded work areas. Ionized air blowers are also recommended.
- Short TEC and Laser Diode leads whenever the laser is transported or stored.
- If industrial loads are switched in or near your laboratory, use isolation transformers and/or a surge suppressor power strip with your laser current source.
- Isolate your TEC driver with a surge suppresser when using a common line with laboratory power supplies, soldering irons, or other electronic instruments. Avoid using such devices on the same surge suppresser as your laser source.
- Make sure all the cables to the Laser Diode and / or TEC are securely fastened. Avoid “bundling” current source cables with other cables in your laboratory.
- Set current and voltage limits to appropriate levels, following the Laser Diode and TEC manufacturers’ recommendations (or to just above the expected operating current). Suggestions include setting the compliance voltage no more than 10% above V_f , and setting the current limit at or below the maximum operating current of the attached device .
- Avoid ground loops.

6.3 TEC Controller Operation

6.3.1 Thermistor and Thermistor Current Selection

6.3.1.1 Introduction

Choosing the right sensing current depends on the range of temperature you want to measure and the resolution you require at the highest measured temperature. To correctly set the thermistor current you must understand how the thermistor and the 6100 interact.

6.3.1.2 Thermistor Range

Thermistors can span a wide temperature range, but their practical range is limited by their non-linear resistance properties. As the sensed temperature increases, the resistance of the thermistor decreases significantly and the thermistor resistance changes less for an equivalent temperature change. Consider the temperature and sensitivity figures below.

<u>Temperature</u>	<u>Sensitivity</u>
-20°C	5600 ohms/°C
25°C	439 ohms/°C
50°C	137 ohms/°C

In the 6100 the practical upper temperature limit is the temperature at which the thermistor becomes insensitive to temperature changes. The maximum ADC input voltage of the 6100 limits the lower end of the temperature range. Thermistor resistance and voltage are related through Ohm's Law ($V = I \times R$). The 6100 supplies bias current to the thermistor, and as the resistance changes, a changing voltage signal is available to the thermistor inputs of the 6100. The 6100 is capable of supplying the following bias currents to the thermistor: 10 mA (100 Ohm), 1 mA (1 kOhm), 100 μ A (10 kOhm), 10 μ A (100 kOhm), 1 μ A (1 MOhm). The 6100 will over-range when the input voltage exceeds about 2.5 Volts. Figure 34 graphically shows the lower temperature and upper voltage limits for a typical 10 kOhm thermistor. The practical temperature ranges for a typical 10 K thermistor (a 10 K thermistor has a resistance of 10 k Ohms at 25°C) are given in the table below.

<u>Sensing Current</u>	<u>Temperature Range</u>
10 μ A	-35 to 40°C
100 μ A	+8 to 80°C

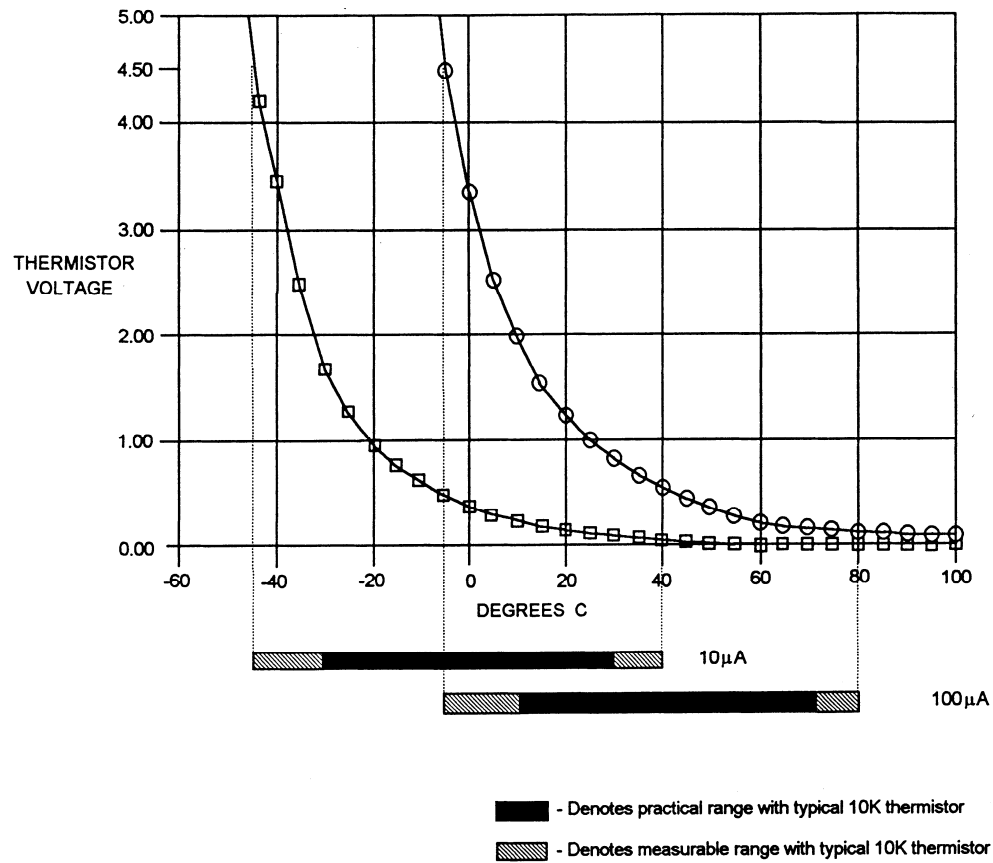

Figure 34 Thermistor Temperature Range

6.3.1.3 Temperature Resolution

You must also consider measurement resolution since the resolution decreases as the thermistor temperature increases. The microprocessor converts this digital number to resistance, stores this resistance, then converts it to a temperature using the Steinhart-Hart equation, and stores this temperature. A temperature change of one degree centigrade will be represented by a greater resistance increase (and therefore more ADC counts) at lower temperatures because of the non-linear resistance of the thermistor. Resolution figures for a typical 10 kΩ thermistor are given below.

Temperature	Voltage at 10 μA	Resolution
-20 °C	56.0 mV/°C	0.018 °C/mV
25 °C	4.4 mV/°C	0.230 °C/mV
50 °C	1.4 mV/°C	0.700 °C/mV

For this thermistor, a temperature change from -20°C to -19°C will be represented by 737 ADC counts (if supplied with $10\mu\text{A}$). The same thermistor will only change about 18 ADC counts from 49°C to 50°C .

6.3.1.4 Selecting Thermistor Current

To select the current setting for a typical $10\text{ k}\Omega$ thermistor, determine the lowest temperature you will need to sample and select the current according to the range limits given above. If the temperature you want to sample is below -10°C you should use the $10\mu\text{A}$ setting.

With the current set to $10\mu\text{A}$ the best resolution you will see will be a 1.0°C temperature change. If, for example, the lower limit is 0°C you can choose either setting, but there is a tradeoff in terms of resolution. If you need better than 0.1°C measurement resolution you will have to change to $100\mu\text{A}$.

If you need high resolution over a narrow range, for a very accurate measurement, you can set the current setting for the maximum resolution. For example, at a high temperature of 15°C , you require a measurement resolution of at least 0.05°C . This resolution is within the range of either setting, but at the $10\mu\text{A}$ setting the resolution is only 0.2°C while at the $100\mu\text{A}$ setting the resolution is better than $.05^{\circ}\text{C}$.

Generally, it is best to use the $100\mu\text{A}$ setting for all measurements of -10°C or greater with a 10 K thermistor.

6.3.1.5 Selecting Thermistors

The type of thermistor you choose will depend primarily on the operating temperature range. These guidelines for selecting the range and resolution will apply to any thermistor. 10 K thermistors are generally a good choice for most laser diode applications where high stability is required near room temperatures. Similarly, 10 K thermistors are often a good choice for cooling applications where you want to operate at temperatures from -40°C to room temperature.

If you require a different temperature range or the accuracy you need can't be achieved with either current setting, select another thermistor. Thermistor temperature curves, supplied by the manufacturer, show the resistance versus temperature range for many other thermistors. Contact a Newport application engineer with your specific application.

6.3.1.6 The Steinhart-Hart Equation

The Steinhart-Hart equation is used to derive temperature from the non-linear resistance of an NTC (Negative Temperature Coefficient) thermistor.

The following section contains an explanation of the Steinhart-Hart equation and the values of these constants for some common thermistors.

Two terminal thermistors have a non-linear relationship between temperature and resistance. The resistance versus temperature characteristics for a family of similar thermistors is shown in Figure 35. It has been found empirically that the resistance versus temperature relationship for most common negative temperature coefficient (NTC) thermistors can be accurately modeled by a polynomial expansion relating the logarithm of resistance to inverse temperature. The Steinhart-Hart equation is one such expression and is given as follows:

$$1/T = C1 + C2 (\text{Ln } R) + C3 (\text{Ln } R)^3 \quad (\text{Eq. 1})$$

where T is in Kelvin. To convert T to °C, subtract 273.15.

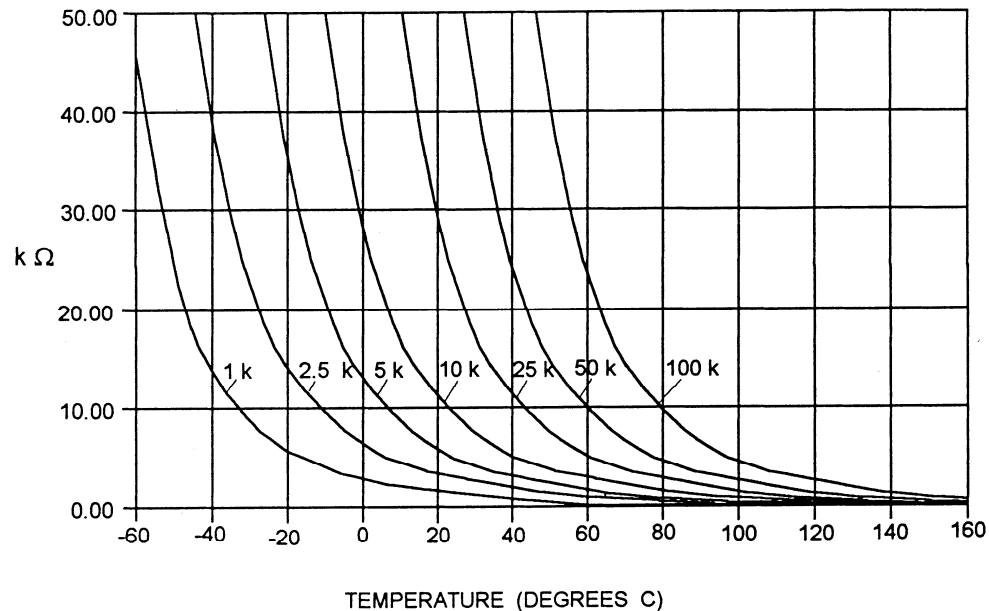

Figure 35 Thermistor Resistance versus Temperature

Once the three constants C1, C2, and C3 are accurately determined, only small errors in the calculation of temperature over wide temperature ranges exist. The equation will produce temperature calculation errors of less than 0.01°C over the range -20 °C to 50 °C.

The constants C1, C2, and C3 are expressed in the form n.nnnn, simplifying entry into the 6100.

6.3.1.7 Table of Constants

Common thermistors and the appropriate calibration constants for the temperature range -20 °C to 50 °C are listed in Table 9. The Model 6100 uses the BetaTHERM 10K3 thermistor values by default.

<i>Manufacturer</i>	<i>C1 * 10⁻³</i>	<i>C2 * 10⁻⁴</i>	<i>C3 * 10⁻⁷</i>
BetaTHERM 10K3	1.129241	2.341077	0.877547
BetaTHERM 0.1K1	1.942952	2.989769	3.504383
BetaTHERM 0.3K1	1.627660	2.933316	2.870016
BetaTHERM 1K2	1.373419	2.771785	1.999768
BetaTHERM 1K7	1.446659	2.682454	1.649916
BetaTHERM 2K3	1.498872	2.379047	1.066953
BetaTHERM 2.2K3	1.471388	2.376138	1.051058
BetaTHERM 3K3	1.405027	2.369386	1.012660
BetaTHERM 5K3	1.287450	2.357394	0.950520
BetaTHERM 10K3	1.129241	2.341077	0.877547
BetaTHERM 10K4	1.028444	2.392435	1.562216
BetaTHERM 30K5	0.933175	2.213978	1.263817
BetaTHERM 30K6	1.068981	2.120700	0.901954
BetaTHERM 50K6	0.965715	2.106840	0.858548
BetaTHERM 100K6	0.827111	2.088020	0.805620

Table 9 Thermistor Constants

6.3.2 AD590 and LM335

6.3.2.1 General

The 6100 uses two constants (C1 and C2) for calibrating the two linear thermal sensing devices, the AD590 and the LM335. C1 is used as the zero offset value, and C2 is used as the slope or gain adjustment. Therefore, C1 has a nominal value of 0, and C2 has a nominal value of 1 when using the AD590 or LM335. In order to calibrate a linear sensor device, the sensor must be operated at an accurately known, stable temperature. For example, the sensor may be calibrated at 0 °C if the sensor is placed in ice water until its temperature is stable. A highly accurate temperature probe, thermometer, environmental chamber, etc., may also be used to determine the known temperature for calibration.

6.3.2.2 AD590 Sensor

The AD590 is a linear thermal sensor that acts as a current source. It produces a current, i , which is directly proportional to absolute temperature, over its useful range (-50 °C to + 150 °C). This nominal value can be expressed as:

$$i = 1 \mu\text{A} / \text{K}$$

where i is the nominal current produced by the AD590, and K is in Kelvin. The 6100 uses i to determine the nominal temperature, T_n , by the formula:

$$T_n = (i / (1 \mu\text{A} / \text{K})) - 273.15$$

where T_n is in $^{\circ}\text{C}$.

The displayed temperature, $T_d = C1 + (C2 * T_n)$, is then computed, where $C1$ and $C2$ are the constants stored in the 6100 for the AD590. The AD590 grades of tolerance vary, but typically, without adjusting $C1$ and $C2$, the temperature accuracy is $\pm 1^{\circ}\text{C}$ over its rated operating range. However, the AD590 is not perfectly linear, and even with $C1$ accurately known there is a non-linear absolute temperature error associated with the device. This non-linearity is shown in Figure 36, reprinted from Analog Devices specifications, where the error associated with $C1$ is assumed to be zero.

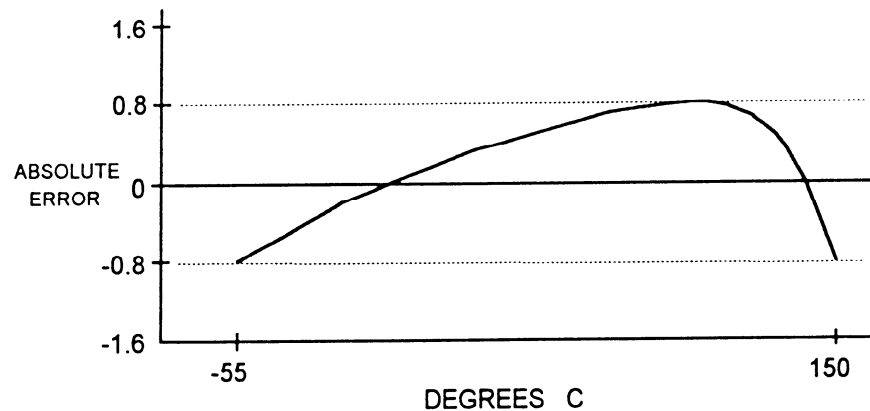

Figure 36 AD590 Nonlinearity

If a maximum absolute error of 0.8°C is tolerable, the one point calibration of $C1$ should be used. If a greater accuracy is desired, the two point method of determining $C1$ and $C2$ should be used. Note however, the absolute error curve is non-linear, therefore the constant $C2$ will vary for different measurement points.

6.3.2.3 LM335 Sensor

The LM335 is a linear thermal sensor that acts as a voltage source. It produces a voltage, v , which is directly proportional to absolute temperature,

over its useful range (-40°C to + 100°C). This nominal value can be expressed as:

$$v = 10\text{mV} / \text{K}$$

where v is the voltage produced by the LM335 and K is Kelvin.

The 6100 uses v to determine the nominal temperature, T_n , by the formula:

$$T_n = (v / (10\text{mV} / \text{K})) - 273.15$$

where T_n is in °C.

The temperature, T_d , which is displayed by the 6100 is calculated as follows:

$$T_d = C1 + (C2 * T_n)$$

where $C1$ and $C2$ are the constants stored in the 6100 for the LM335.

When the LM335 is calibrated to 25°C, $C1 = 0$ and $C2 = 1$, and the temperature accuracy is typically $\pm 0.5^\circ\text{C}$ over the rated operating range. However, the LM335 is not perfectly linear, and even with $C1$ accurately known there is a non-linear absolute temperature error associated with the device. This non-linearity caused error is typically $\pm 0.3^\circ\text{C}$, with the error associated with $C1$ assumed to be zero.

If a maximum absolute error of $\pm 0.3^\circ\text{C}$ can be tolerated, the one point calibration of $C1$ should be used. If a greater accuracy is desired, the two point method of determining $C1$ and $C2$ should be used. Note however, the absolute error associated with the constant $C2$ may vary over different temperature ranges.

6.3.2.4 Determining C1 and C2 for the AD590 and LM335

The nominal values of $C1$ and $C2$ are 0 and 1, respectively, for both types of devices. These values should be used initially for determining $C1$ and $C2$ in the methods described below.

The One Point method is easiest, but it ignores the non-linearity of the device. It is most useful when a high degree of temperature accuracy is not required.

The Two Point method can achieve a high degree of accuracy over a narrower operating temperature range, but requires two accurate temperature measurements.

One Point Calibration Method

The accuracy of this procedure depends on the accuracy of the externally measured temperature. It is used to determine the zero offset of the device, and it assumes that the gain (slope) is known.

1. Allow the 6100 to warm up for at least one hour. Select the desired sensor type in the setup menu.
2. Set the C1 parameter to zero. Set the C2 parameter to 1.
3. Place the sensor at an accurately known and stable temperature, T_a . Connect the sensor to the 6100 for normal Constant temperature operation. Allow the 6100 to stabilize at the known temperature, T_a and read the displayed temperature, T_d .
4. Determine the new value of C1 from the formula:

$$C1 = T_a - T_d$$

and enter the new C1 value.

Two Point Calibration Method

The accuracy of this procedure depends on the accuracy of the externally measured temperature. It is used to determine the zero offset of the device and the gain (slope).

1. Allow the 6100 to warm up for at least one hour. Select the desired sensor type in the setup menu.
2. Set the C1 parameter to zero. Set the C2 parameter to 1.
3. Place the sensor at an accurately known and stable temperature, T_{a1} . Connect the sensor to the 6100 for normal Constant temperature operation. Allow the 6100 to stabilize at the known temperature, T_{a1} and read the displayed temperature, T_{d1} . Record these values.
4. Repeat Step 3 for another known temperature, T_{a2} , and the corresponding displayed temperature, T_{d2} . The two known temperatures should be at the bounds of the intended operating range.

For best results, make the range between T_{a1} and T_{a2} as narrow as possible.

- Determine the new value of C1 and C2 from the following calculations.

$$C2 = (T_{a1} - T_{a2}) / (T_{d1} - T_{d2}), \text{ and}$$

$$C1 = T_{a1} - (T_{d1} * C2)$$

- Enter the new C1 and C2 values.

6.3.3 RTD Sensors

The following equation is used in temperature to resistance conversions:

$$R_T = R_0 [1 + (C1 \times T) + (C2 \times T^2) + (C3 \times (T-100) \times T^3)] \text{ for } T < 0^\circ\text{C}$$

$$R_T = R_0 [1 + (C1 \times T) + (C2 \times T^2)] \text{ for } T \geq 0^\circ\text{C}$$

where: R_T is the resistance in Ω at temperature T .

T is the temperature in $^\circ\text{C}$.

6.3.3.1 RTD Constants

The constants entered for an RTD depend on the type of curve it has. Table 10 shows three standard types.

Curve	TCR ($\Omega/\Omega/^\circ\text{C}$)	C1	C2	C3	R_0
Laboratory	.003926	3.9848×10^{-3}	-0.58700×10^{-6}	-4.0000×10^{-12}	100.00
US	.003910	3.9692×10^{-3}	-0.58495×10^{-6}	-4.2325×10^{-12}	100.00
European	.003850	3.9080×10^{-3}	-0.58019×10^{-6}	-4.2735×10^{-12}	100.00

Table 10 RTD Constants

The R_0 constant also applies for RTD sensors. It is the RTD value at 0°C and is nominally 100.00Ω , but can be varied from 95.00Ω to 105.00Ω .

6.4 Laser Diode Driver Operation

6.4.1 Operating Modes

The Model 6100's Laser Diode Driver subsystem operates in one of two modes – CW or EXTERNAL ANALOG CONTROL. Following power-up, the unit always will be in CW mode. The user may then change to EXTERNAL ANALOG CONTROL mode using the LAS:MODE command via the USB interface. See Section 5.5 for more information on this command. It is not possible to change the operating mode from the front panel of the unit.

Operating mode is not retained in the unit at power down. This means that the unit will always power up in CW operating mode with the output disabled.

It is not possible to enable the output circuitry using the Analog Control input signal when the Interlock signal, Output Disable signal, etc., are disabling the output circuitry.

6.4.1.1 CW Mode

In CW Mode, the output current will be enabled whenever the rear-panel IO Signals Connector's Interlock pin is grounded and the output is enabled via the USB interface or the front panel LASER DIODE OUTPUT switch. (For safety, there actually is a three second delay between all of these conditions being met and the current output commencing). The amount of output current is the lesser of the Setpoint and the current limit, subject to some slew-rate limiting to avoid overshoots.

6.4.1.2 EXTERNAL ANALOG CONTROL Mode

External Analog Control Mode functions almost identically to CW Mode, except that the output current is the lesser of the amount requested via the rear-panel SIGNALS I/O connector's LD Analog Control input pin and the current limit.

The LD Analog Control input takes a voltage range of 10V. Each 100 mV represents 1% of the driver's maximum operating current, which gives a range of 0% at 0V to 100% at 10V. In other words, the value of the Setpoint is ignored.

The LD Analog Control input is digitally sampled at a 100 Hz rate; the user must not attempt to drive this input with a signal containing any appreciable energy above 50 Hz.



WARNING

The LD Analog Control input should not be used to implement a safety interlock because it does not have a 3-second safety delay before enabling the output circuitry.

6.4.2 Control Modes

The Model 6100's Laser Diode Driver subsystem operates in one of two control modes – Constant Current Control Mode or Constant Power Control Mode. Following power-up, the unit always will be in Constant Current Control Mode. The user may then change to Constant Power Control Mode using the LAS:MODE command via the USB interface. See Section 5.5 for more information on this command. It is not possible to change the operating mode from the front panel of the unit.

Operating mode is not retained in the unit at power down. This means that the unit will always power up in Constant Current Control Mode.

6.4.2.1 Constant Current Control Mode

In Constant Current Control Mode the Laser Diode Driver subsystem will servo its output current based on output current measurements it makes.

6.4.2.2 Constant Power Control Mode

In Constant Power Control Mode the Laser Diode Driver subsystem will servo its output current based on the current through the attached laser diode's back-facet diode.

6.4.2.3 MODULATION Input



WARNING

When using the current modulation feature, ensure that the modulation signal source is disabled before enabling the 6100 laser current output. Turning on the laser current output when the modulation is enabled can cause current transients that can damage laser diodes.

The Modulation Input allows the modulation of the laser diode by an external signal source through the BNC input, which is a differential input. The output current level to the laser diode can be set using an external voltage source, or it can be modulated with a function generator signal. Any input modulation signal is added to the DC drive current level set by the front panel control knob. A bandwidth selection switch on the back panel introduces a dampening filter in the output control loop to reduce the output noise when external modulation is not required. If the output drive current does not respond to a modulation frequency above 10kHz, check the switch to make sure it is not in the LOW bandwidth position.

The Modulation Input can be turned off from the LDD Params menu, to reduce the picked up noise from its BNC connector, when the laser current is not modulated (see 4.4.9.1).

6.4.2.4 Photodiode Input and Bias Adjustment

A monitor photodiode may be reverse biased up to -5 volts using the PD BIAS adjustment screw. In the farthest counter-clockwise position the photodiode is zero biased. Turning the screw clockwise increases the bias voltage.

6.5 TTL Output Modes

The TTL Output signal on the rear panel SIGNALS I/O connector allows the user to monitor certain states of the Model 6100, or to control or trigger external measurement equipment. This output operates one of five modes – LOW, HIGH, ENABLE OUTPUT MONITOR, PULSE MONITOR, and TTL INPUT MONITOR.

Following power-up, the unit always will be in ENABLE OUTPUT MONITOR TTL output mode. The user may then change to one of the other TTL output modes using the LAS:TTL:MODE command via the USB interface. See Section 5.5 for more information on this command. It is not possible to change the operating mode from the front panel of the unit.

Operating mode is not retained in the unit at power down.

6.5.1 LOW TTL Mode

In LOW TTL mode, the open-collector output pulls the TTL Output signal to Digital Ground.

6.5.2 HIGH TTL Mode

In HIGH TTL mode, the open-collector output is floated and the 1.5 kohm resistor pulls the TTL Output signal to +5V.

6.5.3 ENABLE OUTPUT MONITOR TTL Mode

In ENABLE OUTPUT MONITOR TTL mode, the TTL Output signal indicates when the Laser Diode Driver subsystem is outputting current or is capable of doing so without the normal 3-second safety delay.

Normally, the TTL Output signal will be HIGH when the unit is supplying current to a laser diode and LOW when the unit is not. There are two exceptions to this. One exception is when output current is enabled, but it is blocked because the unit is between pulses in GATED, TRIGGERED, RETRIG, and FREE RUN pulse modes. The other exception is when output current is enabled but the unit is in EXTERNAL ANALOG CONTROL operating mode and the Analog Control input signal on the rear-panel IO

Signals Connector is driven to ground. In these exceptions, the TTL Output signal will be HIGH to indicate that the unit is capable of supplying output current without the normal 3-second safety-delay.

6.5.4 PULSE MONITOR TTL Mode

In PULSE MONITOR mode allows the user to synchronize external instrumentation to the laser diode output current pulses when the unit is in GATED, TRIGGERED, RETRIG, or FREE RUN pulse mode.

When the output current is enabled in these modes, TTL Output signal will be HIGH when unit is supplying current and LOW when it is not. The state of the TTL Output signal is not specified in ALWAYS ON pulse mode; it is also not specified if the output current is disabled.

6.5.5 TTL INPUT MONITOR TTL Mode

In TTL INPUT MONITOR TTL mode, logic level present on the TTL Input signal is buffered and output on the TTL Output signal.

6.6 LIV Characterization

NOTE

For fast LIV characterization, with measurements every 10 ms, use HWCONFIG command to set bit 2 of the configuration register to 1.

The Model 6100 supports a data acquisition engine that enables users to perform LIV characterization of laser diodes with relative ease. The users can define their desired start and end output current values, number of measurements and the dwell time at each current step. Once the LIV characterization process is enabled, the unit starts to increase/decrease the output current based on these setup parameters. At every current step it measures and stores internally the following four (4) parameters: current setpoint, measured current, forward voltage and analog control input voltage. The unit is capable of storing up to 100 such measurement sets. Users can retrieve these measurements from the unit via USB interface for further analysis. The unit is designed to take a measurement every 10 ms. By default, the data is averaged over a period of 500 ms, which is suitable for most applications. If the user needs to perform fast LIV characterizations, the raw data taken at every 10 ms can be made available via USB. For this, the user needs to set bit 2 in the configuration register to 1. By default, this bit is 0. (See the HWCONFIG command in Section 5.5)

By measuring analog control input voltage at the same time as current setpoint, measured current and forward voltage, the unit enables users to truly

synchronize measurements from instruments such as power meter or temperature controller with laser diode current and voltage values. For instance, users can supply voltage that represents photodiode current or thermopile voltage from a power meter to the analog control input to determine current versus optical power characteristics of a laser diode.

Note that when the LIV characterization process is enabled, the laser output is not turned ON automatically, if it is in an OFF state. This feature allows users to simulate LIV characterization process with the output turned OFF.

A typical command sequence to setup and initiate an LIV characterization process is as follows:

HWCONFIG 4	<i>Set the configuration register for fast data measurements</i>
LAS:LIV:SETUP 0.0,100.0,100,100	<i>Set Start current = 0.0A; End current = 100.0A; Number of measurements (same as current steps) = 100; Dwell time before each measurement = 100ms.</i>
LAS:OUT 1	<i>Turn laser output ON, if it is in OFF state.</i>
LAS:LIV:EN 1	<i>Wait for ONDELAY timer to expire before starting LIV characterization process.</i>
LAS:LIV:COUNT?	<i>Query the number of measurements taken. Wait until the number of measurements is one (1) more than the desired number.</i>
LAS:LIV:GETMEAS?	<i>Read the measurements from the unit. Issue this command once, and read responses from the unit repeatedly until the unit responds with “End of data” string.</i>

7 Tips and Techniques

7.1 Introduction

This section explains operational details of the Model 6100 Laser Diode and Temperature Controller and provides application examples.

7.2 TEC Limits

The Temperature Controller subsystem has several limits to protect the TEC from damage. The limits include current and compliance voltage.

7.2.1 Current Limit

There are two types of current limit:

- In the first type, the TEC controller processor does not allow the driver output to exceed the limit's set point via front panel or USB command. This form of limiting is called the **soft limit**, and does not affect the operation of the TEC except to limit the drive current.
- In the second type, the high-speed DSP processor monitors the actual TEC current and if that exceeds the limit set point for any reason then the output is immediately shut down. This form of limit is called the **hard limit**. The Temperature Controller will always be shut down on a hard limit.

7.2.2 Voltage Limit

The control processor continuously monitors output condition and prevents overdriving the TEC voltage. When the voltage limit is reached, the Temperature Controller output current is shut off to prevent damage to the TEC.

7.2.3 Operating at or Near I_o and V_{te} Limits

Because of the sensitivity of the limit circuits, operating at or near the limit unless necessary is not recommended. AC line transients, RF interference, or static can be enough to trigger these limits. Triggers for hard limits and voltage compliance limits vary, but can include the following:

- Static discharges, which may cause enough noise to trigger the circuit.
- Turning on the laser when its set point is at or near the limit. Turning on the output with the set point at the limit can cause a small overshoot in

the drive current, which the limit circuitry may pick up as a hard limit and shut down the Temperature Controller subsystem.

7.3 Grounding a TEC

The Model 6100 Temperature Controller outputs are isolated from earth (chassis) ground. Isolating the TEC case avoids damaging the device from multiple ground loop potentials, AC transients, or static discharge. Since test equipment probes, signal sources, and package mounts are often partially earth grounded, it is often necessary to also bond the device case to earth ground. It is strongly recommended that a single point ground scheme be established, specifically at the binding post. This will help minimize noise, transients, and ground loop hazards. Be sure to include any signal generators in your ground circuit.

	<p style="text-align: center;">CAUTION</p> <p>Do not connect the temperature sensor to Earth Ground at the same time with grounding either TE+ or TE-. Only one connection to ground is accepted. Failure to do so may result in the unit malfunction or/and damage. Be careful when connecting other instruments to 6100 Laser Diode and Temperature Controller, as they may have their ground connected to the Earth Ground.</p> <p>For example, oscilloscopes have the probe ground connected to Earth Ground. If either TE+ or TE- is already connected to Earth Ground, the oscilloscope may bring the second connection, causing malfunction or damage.</p>
--	--

If you have additional questions about your earth grounding method, contact a Newport applications engineer.

7.4 Laser Limits

The Laser Diode Driver subsystem has several limits to protect the laser diode from damage. The limits include current and compliance voltage.

7.4.1 Current Limit

The current limit is actually two limit circuits:

- The first circuit maintains the current limit by not allowing the drive current to exceed the limit's set point. This form of limiting is called the **soft limit**, and does not affect the operation of the laser except to limit the drive current.

- The second circuit monitors the actual current drive and, if that exceeds the limit set point, shuts down the output. This form of limit is called the **hard limit**. The Laser Diode Driver subsystem will always be shut down on a hard limit.

7.4.2 Voltage Limit

A special limiting circuit prevents overdriving the Laser Diode voltage. When the voltage limit is reached, the output current is shut off to prevent damage to the laser diode.

7.4.3 Operating at or Near I_o and V_{comp} Limits

Because of the sensitivity of the limit circuits, operating at or near the limit unless necessary is not recommended. AC line transients, RF interference, or static can be enough to trigger these limits. Triggers for hard limits and voltage compliance limits vary, but can include the following:

- Static discharges, which may cause enough noise to trigger the circuit.
- Turning on the laser when its set point is at or near the limit. Turning on the output with the set point at the limit can cause a small overshoot in the drive current, which the limit circuitry may pick up as a hard limit and shut down the laser.

7.5 External LD Analog Control

External analog control allows external control of the laser diode operating current. By supplying an input voltage, the operator can set the laser diode operating current anywhere within the full range of the laser controller, although the output will still be limited by the current limit.

The analog control input takes a voltage range of 10V. Each 100 mV represents 1% of the driver's maximum operating current, which gives a range of 0% at 0V to 100% at 10V.

7.5.1 Using the LD Analog Control Input as the Set Point

It is possible to fully control the laser diode set point through the analog control input by setting Laser Diode Driver subsystem unit into this analog control mode via USB command (i.e., LAS:MODE command, see Section 5.5) The analog input voltage can then be ranged from 0V to 10V to give the full range of current output. Note, however, that the current limit is still active, and will not allow the current to exceed the current limit. Also note that the laser diode driver reverts back to normal CW mode (i.e., it's no longer in Analog Control Mode) after a system reset or power cycle.

7.5.2 Grounding Considerations when using the LD Analog Control Input

Most signal generators and oscilloscopes have a BNC output that is connected to earth ground. This is not a problem as long as the laser anode or cathode are not also connected to earth ground. However, in many systems,

they are. When one of them is connected to ground, the following must be considered:

When the anode is tied to earth ground, this effectively connects earth ground to up to +15V DC referenced to Laser Diode Analog Ground. When the BNC on the control source is connected to the instrument input, it biases the LD Analog Control Input and the control signal range is reduced. Thus, it may appear that the analog control input is not working properly. Therefore, it is recommended that the laser diode leads be disconnected from the earth ground.

7.6 Grounding a Laser Diode

The laser outputs are isolated from earth (chassis) ground. Isolating the laser diode case avoids damaging the device from multiple ground loop potentials, AC transients, or static discharge. Since test equipment probes, signal sources, and package mounts are often partially earth grounded, it is often necessary to also bond the device case to earth ground. It is strongly recommended that a single point ground scheme be established, specifically at the binding post. This will help minimize noise, transients, and ground loop hazards. Be sure to include any signal generators in your ground circuit.

If you have additional questions about your earth grounding method, contact a Newport applications engineer.

7.7 V_f Measurements

The attached laser diode's forward voltage (V_f) is normally sensed at Laser Diode Driver subsystem output connector. This is not the actual V_f of the laser, the difference being the voltage drop in the cables due to the laser diode current.

Use the Anode and Cathode voltage sense inputs on the SIGNALS I/O connector (located on the rear panel) to monitor the actual voltage across the laser diode, in a 4-wire configuration. Note that it is necessary to send the HWCONFIG command via USB (see Section 5.5) in order for the controller to monitor and display actual laser diode forward voltage on the front panel and via USB commands query. It is recommended to use shielded sense wires, or, at minimum, a twisted pair cable.

8 Maintenance and Service



WARNING

There are no user serviceable parts inside the Model 6100 Laser Diode and Temperature Controller. Work performed by persons not authorized by Newport Corporation will void the warranty.

8.1 Enclosure Cleaning



WARNING

Before cleaning the enclosure of the Model 6100 Laser Diode and Temperature Controller, the AC power cord must be disconnected from the wall socket.

The source enclosure should only be cleaned with a mild soapy water solution applied to a damp lint-free cloth. Do not use an acetone or alcohol solution; this will damage the finish of the enclosure.

8.2 Obtaining Service

The Model 6100 Laser Diode and Temperature Controller contains no user serviceable parts. To obtain information regarding factory service, contact Newport Corporation or your Newport representative. Please have the following information available:

1. Instrument model number (on the rear panel)
2. Instrument serial number (on rear panel or bottom of enclosure)
3. Description of the problem.

If the instrument is to be returned to Newport Corporation, you will be given a Return Number, which you should reference in your shipping documents. Please fill out a copy of the service form, located on the following page, and have the information ready when contacting Newport Corporation. Return the completed service form with the instrument.

8.3 Service Form



Newport®
Experience | Solutions

Newport Corporation U.S.A.
Office: 800-222-6440
FAX: 949/253-1479

Name _____ Return Authorization # _____
(Please obtain RA# prior to return of item)

Company _____
(Please obtain RA # prior to return of item)

Address _____ Date _____

Country _____ Phone Number _____

P.O. Number _____ FAX Number _____

Item(s) Being Returned:

Model # _____ Serial # _____

Description _____

Reason for return of goods (please list any specific problems):

9 Appendix A – Error Messages

9.1 Introduction

The communication errors can be retrieved with the following commands: ERR? or ERRSTR?. The descriptions of the returned errors are detailed in the next sections.

9.2 Error Description

A description of error codes and corresponding error strings generated by the TEC Driver is given below:

Error Code	Error String	Description
0	NO ERROR	No error exists in the error buffer
116	SYNTAX ERROR	This error is generated when the instrument receives a command that cannot be processed. Some typical causes: <ol style="list-style-type: none">Using ASCII characters outside of a string constant that are not defined by the command language syntax.Missing space between a set command and parameter.Missing “?” character in case of query
126	WRONG NUM OF PARAM	This error is generated when the instrument is unable to process a command due to a mismatch between the number of parameters received and the number of parameters required for the command.
200	REMOTE MODE	This error is generated when the instrument is in REMOTE mode and the user tries to change settings using front panel.
201	VALUE OUT OF RANGE	This error is generated when the instrument is unable to process a command because the parameter value received is out of range of the acceptable values for the command.
203	WRONG PULSE	This error is generated when the instrument receives either

	WIDTH	“LASer:PULse:FREQuency” or “LASer:PULse:WIDTh” commands with parameter settings that violate the following constraint: pulse width must be less than pulse period (1/frequency).
402	TEC SENSOR OPEN	The Temperature Controller subsystem output has been turned OFF because the input voltage from AD590 sensor is less than -0.50V or voltage from LM335 sensor is greater than 1.50V . Once the fault is corrected, “TEC:OUTput 1” command must be issued to clear the error indication, and to restore current to the TE module.
405	TEC VOLTAGE LIMIT	The Temperature Controller subsystem output has been turned OFF because the forward voltage drop of a TE module exceeds the compliance voltage specified in the Specification table. Once the fault is corrected, “TEC:OUTput 1” command must be issued to clear the error indication, and to restore current to the TE module.
406	TEC RES LIMIT	The Temperature Controller subsystem output has been turned OFF because the measured sensor resistance/reference value is either less than or greater than the specified RLO and RHI limits respectively. “TEC:OUTput 1” command must be issued to clear the error indication, and to restore current to the TE module.
407	TEC TEMP LIMIT	The Temperature Controller subsystem output has been turned OFF because the measured temperature value is either less than or greater than the specified TLO and THI limits respectively. “TEC:OUTput 1” command must be issued to clear the error indication, and to restore current to the attached TEC.
409	TEC SENSOR CHANGE	The Temperature Controller subsystem output has been turned OFF because the feedback sensor type was changed either through the setup menu on front panel or through PC communication (TEC:SENsor command).
415	TEC SENSOR SHORT	The Temperature Controller subsystem output has been turned OFF because the input voltage from AD590 sensor is greater than 1.50V or voltage from LM335 sensor is less than -0.50V . Once the fault is corrected, “TEC:OUTput 1” command must be issued to clear the error indication, and to restore current to the TE module.
419	TEC MODE CHANGE	The Temperature Controller subsystem output has been turned OFF because a mode change was commanded using either “TEC:MODE:Ite” or “TEC:MODE:R” or “TEC:MODE:T” commands or through front-panel interface.
424	TEC OVER TEMP	The Temperature Controller subsystem output has been turned OFF because the internal heatsink temperature has exceeded safe levels. Please allow the unit to cool down before turning the output ON again.

434	WRONG TEC SENSOR	This error is generated when user tries to set custom thermistor sensor rating using TEC:THERM command, but the sensor type is not a Custom Thermistor.
501	LDD INTERLOCK FLT	The Laser Diode Driver subsystem output has been turned OFF because of remote interlock assertion (Laser Diode Driver subsystem output connector).
502	LDD CURRENT LIMIT	The Laser Diode Driver subsystem output has been turned OFF because of actual current exceeding the current limit set point.
503	LDD OPEN CIRCUIT	The Laser Diode Driver subsystem output has been turned OFF because of open circuit condition.
505	LDD VOLTAGE LIMIT	The Laser Diode Driver subsystem output has been turned OFF because of actual forward voltage exceeding the forward voltage rating of instrument.
513	LDD RANGE CHANGE	The Laser Diode Driver subsystem output has been turned OFF because a range change was commanded using "LASer:RANGE" command or through front-panel interface.
514	LDD MODE CHANGE	The Laser Diode Driver subsystem output has been turned OFF because a range change was commanded using either "LASer:MODE" or "LASer:MODE:LDI" or "LASer:MODE:MDI" or "LASer:MODE:MDP" commands or through front-panel interface.
515	LDD BANDWIDTH CHG	The Laser Diode Driver subsystem output has been turned OFF because a bandwidth change was commanded using "LASer:BW" command or through front-panel interface.
524	LDD OVER TEMP	The Laser Diode Driver subsystem output has been turned OFF because the internal heatsink temperature has exceeded safe levels. Please allow the unit to cool down before turning the output ON again.
526	LDD PD RESP CHG	The Laser Diode Driver subsystem output has been turned OFF because photodiode responsivity change was commanded using "LASer:CALMD" command or through front-panel interface.
537	LIV IN PROGRESS	This error is generated when user attempts to issue "LAS:LIV:SETUP" or "LAS:LIV:ENable 1" commands when LIV characterization process is already turned ON.
901	SYSTEM OVER TEMP	The LDD and TEC outputs have been turned OFF because the temperature inside the instrument has exceeded safe levels. Please allow the unit to cool down before turning the output ON again.

918	TEC OUTPUT OFF	This error is generated when user attempts to enable LDD output with TEC output disabled. It is also generated when LDD output is disabled automatically due to TEC output getting disabled. This laser diode protection requires bit #7 in hardware configuration register is set to zero.
-----	----------------	---

This page is intentionally left blank

**Newport Corporation
Worldwide Headquarters**

1791 Deere Avenue
Irvine, CA 92606

(In U.S.): 800-222-6440
Tel: 949-863-3144
Fax: 949-253-1680

Internet: sales@newport.com



Newport®
Experience | Solutions

Visit Newport Online at: www.newport.com

Newport Corporation, Irvine, California; Evry and Beaune-La-Rolande, France have all been certified compliant with ISO 9001 by the British Standards Institution. Mountain View, California is DNV certified.

Printed in U.S.A.