

Vision IsoStation™



User's Manual



Newport®

Experience | Solutions

Vision IsoStation™

Users Manual

Warranty

Newport Corporation warrants that this product will be free from defects in material and workmanship and will comply with Newport's published specifications at the time of sale for a period of one year from date of shipment. If found to be defective during the warranty period, the product will either be repaired or replaced at Newport's option.

To exercise this warranty, write or call your local Newport office or representative, or contact Newport headquarters in Irvine, California. You will be given prompt assistance and return instructions. Send the product, freight prepaid, to the indicated service facility. Repairs will be made and the instrument returned freight prepaid. Repaired products are warranted for the remainder of the original warranty period or 90 days, whichever first occurs.

Limitation of Warranty

The above warranties do not apply to products which have been repaired or modified without Newport's written approval, or products subjected to unusual physical, thermal or electrical stress, improper installation, misuse, abuse, accident or negligence in use, storage, transportation or handling. This warranty also does not apply to fuses, batteries, or damage from battery leakage.

THIS WARRANTY IS IN LIEU OF ALL OTHER WARRANTIES, EXPRESSED OR IMPLIED, INCLUDING ANY IMPLIED WARRANTY OF MERCHANTABILITY OR FITNESS FOR A PARTICULAR USE. NEWPORT CORPORATION SHALL NOT BE LIABLE FOR ANY INDIRECT, SPECIAL, OR CONSEQUENTIAL DAMAGES RESULTING FROM THE PURCHASE OR USE OF ITS PRODUCTS.

First printing 2009

© 2009 by Newport Corporation, Irvine, CA. All rights reserved. No part of this manual may be reproduced or copied without the prior written approval of Newport Corporation.

This manual has been provided for information only and product specifications are subject to change without notice. Any change will be reflected in future printings.

Newport Corporation
1791 Deere Avenue
Irvine, CA, 92606 USA

Table of Contents

Warranty.....	ii
Table of Contents	iii
List of Figures	v
Section 1 – General information	6
1.1 Introduction	6
1.2 Getting Started.....	6
1.3 Unpacking and Inspection	6
1.4 Safety Considerations	6
1.5 System Placement.....	7
1.6 Air Supply Requirements	7
1.7 Warranty Information.....	8
2 Section 2 – Unpacking and Assembly	9
2.1 Unpacking and Inspecting	9
2.2 Leveling the breadboard on the frame	11
2.3 Floating the Breadboard	13
2.4 Adjusting Leveling Valve Sensors	13
2.5 Optional Accessories	16
2.6 Corner Block Mounting Hole Locations	17
3 Section 3 – Operation	18
3.1 Principles of Operation.....	18
3.2 Performance Adjustments	18
3.2.1 Stabilizing high center-of-mass loads	18
3.2.2 Improving leveling response times.....	19
3.2.3 Breadboard loads and/or load positions change	19
3.3 Maintenance	19
3.3.1 Cleaning.....	19
3.3.2 Air Quality.....	20
4 Section 4 – Troubleshooting	21
4.1 System Does Not Float.....	21
4.2 Poor Isolation Performance	21

4.3 System Oscillates.....22
4.4 System Leaks Air Constantly22

Section 5 – Factory Service 23

4.5 Obtaining Factory Service23

5 Service Form 24

List of Figures

Figure 1	Packed Vision IsoStation	9
Figure 2	Packaged Vision IsoStation with crate cover removed.....	10
Figure 3	Vision IsoStation on shipping pallet	10
Figure 4	Vision IsoStation “roll off” ramp installation	10
Figure 5	Removing shipping bands from the Vision IsoStation	10
Figure 6	Retracting leveling feet	11
Figure 7	Rolling Vision IsoStation off of shipping pallet	11
Figure 8	Bubble level location on Vision IsoStation frame	12
Figure 9	Close up of Vision IsoStation corner block showing location of bubble level.....	12
Figure 10	Vision IsoStation retractable caster adjustment.....	12
Figure 11	Shipping screw location – Each isolator has 2 shipping screws that will need to be removed in order to engage the horizontal leveling mechanism.	13
Figure 12	Vision IsoStation ARF and air compressor line conection.....	13
Figure 13	The bottom of the breadboard is below the float height indicator. The leveling valve control arm screw should be rotated counter- clockwise.....	14
Figure 14	The bottom of the breadboard is even with the float height indicator. The leveling valve control arm screw does not need adjustment.....	14
Figure 15	The bottom of the breadboard is higher than the float height indicator. The leveling valve control arm screw should be rotated clockwise.....	14
Figure 16	Leveling valve diagram.....	15
Figure 17	Corner block mounting hole locations	17
Figure 18	Stability Diagram	19

Section 1 – General information

1.1 Introduction

The Vision IsoStation vibration isolated workstation provides an ideal working platform for vibration influenced devices such as interferometers, microscopes, and balances. Sensitive instruments such as these will show significant improvements in resolution and repeatability when isolated from floor motion by the IsoStation pneumatic suspension system. This versatile workstation is available in a broad range of sizes, working surfaces, isolator capability, and accessory options.

Special care was taken to ensure excellent performance in the 10-50 Hz floor vibration frequency range corresponding to dominant ambient vibration frequencies common to multi-floor buildings. The modular pneumatic isolators provide excellent protection against both vertical and horizontal floor motions.

These workstations integrate Newport's rigid, laminated honeycomb panel technology and pneumatic isolation systems to provide a mounting platform which is rigid, yet thin and lightweight. Equipped with standard casters, the system is easy to move without heavy equipment and may be safely lifted by building elevators.

1.2 Getting Started

Please read this instruction manual thoroughly before assembling the isolation system. The individual components have been assembled at the factory and require only final system assembly and performance adjustment.

1.3 Unpacking and Inspection

The components of your Newport Vibration Control System are packed in individual, labeled boxes. Carefully inspect all components for shipping damage.

Report any shipping damage immediately to Newport and the shipping company.

1.4 Safety Considerations

The following terms are used in this manual that relate to your safety.

**WARNING**

Warning is used to indicate dangers that could result in personal injury.

**CAUTION**

Caution is used to indicate situations that may result in damage to components of your Newport Vibration Control System.

1.5 System Placement

To ensure optimal performance from your Vision IsoStation, it should be located on a level surface. Uneven floors or mounting surfaces may cause difficulty if their irregularity is outside of the adjustment range of the leveling feet.

The Vision IsoStation frame must be mounted so that its axis is not more than 0.5 degrees from vertical. This is necessary for the isolator to function properly in the horizontal mode. If the floor where the isolators are being mounted has a depression of more than 0.2 inches under one side of the base, then the floor should be grouted or shimmed level at this location.

If the system is not located on the ground floor of the building, it should be located near primary vertical structures such as exterior walls or support columns. By locating the Vision IsoStation near these structures, the effects of low frequency floor motion will be minimized, thus increasing isolator performance. It is also advisable to avoid locations adjacent to major sources of vibration from operating machinery such as elevators, air conditioning plants, or factory equipment.

1.6 Air Supply Requirements

A constant supply of air must be connected to the isolators during operation. After initial setup and filling, the isolators consume air only when the leveling valves adjust the pressure to compensate for changes in the load on the breadboard. Bottled nitrogen or mechanically compressed air may be used.

Note that the maximum operating pressure for the system is 90 psig (6.3 kg/cm²).

The Newport Model ACWS air compressor is an extremely quiet source of clean, pressure regulated air. If another compressor or plant air is used, the Newport model ARF air regulator filter should be used to ensure maintenance

free operation. These filters prevent water and dirt from getting into the leveling valves and causing the valves to fail due to clogging.

The air supply should include a shut off valve so that the air may be shut off during maintenance or extensive setup when the load is changed drastically.

**CAUTION**

Bottled carbon dioxide (CO²) is not recommended since “icing” can occur during rapid filling of the isolators.

1.7 Warranty Information

Warranty information may be found on the page preceding the Table of Contents in this manual. Should it become necessary to exercise the warranty, contact your Newport representative to determine the proper course of action. Newport Corporation maintains offices throughout the United States and other locations worldwide. Refer to the back cover of this manual for the addresses and telephone numbers of these offices.

2 Section 2 – Unpacking and Assembly

2.1 Unpacking and Inspecting

Unpack the Vision IsoStation from the cardboard and wood shipping crate. Use the sequence of photo's below to unpack your Vision IsoStation. Inspect all of the parts for shipping damage.



WARNING

The breadboard is not bolted to the Vision IsoStation frame. Do not turn the frame on its side without first removing the breadboard. Personal injury may result.

1. Cut the shipping bands from the box and remove the top of the box from the Vision IsoStation Crate.



Figure 1 Packed Vision IsoStation

2. Remove the cardboard from the perimeter of the Vision IsoStation pallet. The cardboard perimeter is stapled to the pallet with heavy duty staples.



Figure 2 *Packaged Vision IsoStation with crate cover removed.*

3. Remove the wooden ramp from the top of the workstation.



Figure 3 *Vision IsoStation on shipping pallet*

4. Place the ramp on the lip of the pallet.



Figure 4 *Vision IsoStation “roll off” ramp installation*

5. Use a wire cutter to cut the bands securing the Vision IsoStation to the pallet



Figure 5 *Removing shipping bands from the Vision IsoStation*

6. Raise the foot pad on each leg by rotating the orange thumbwheel.



Figure 6 Retracting leveling feet

7. Once all four footpads are raised roll the Vision IsoStation down the ramp and move into installation position in your lab.



Figure 7 Rolling Vision IsoStation off of shipping pallet

2.2 Leveling the breadboard on the frame

The Vision IsoStation includes pre-installed bubble levels to aide in leveling the frame. The bubble levels are installed on the corner blocks of the Vision IsoStation frame. See figures 8 and 9 for bubble level location.

Note that only 2 of the 4 corner blocks have bubble levels.

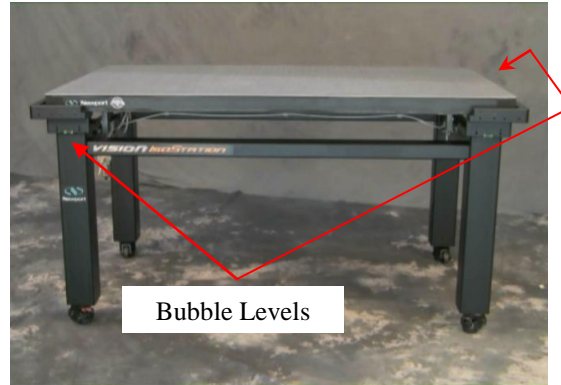

Figure 8 Bubble level location on Vision IsoStation frame

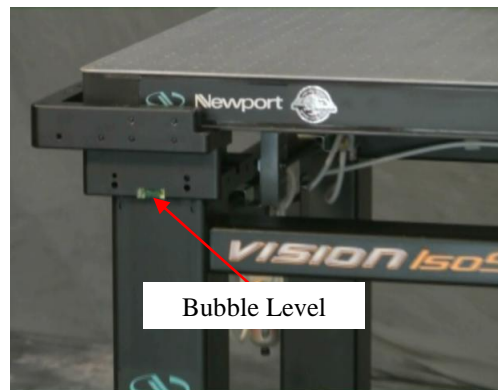

Figure 9 Close up of Vision IsoStation corner block showing location of bubble level

Lower each leveling foot by rotating the orange thumbwheel in a clockwise direction with your hand. Each foot should be lowered until the caster is no longer in contact with the floor and the bubble indicators are in the center of the level indicator marks. The frame is now level.



Figure 10 Vision IsoStation retractable caster adjustment

2.3 Floating the Breadboard

The valves, ARF and all air tubing is preinstalled on the isolated versions of the Vision IsoStation. Additionally, all of the leveling valves are factory adjusted to float your breadboard without a payload. 40 feet of translucent ¼" diameter tubing has been provided with the Vision IsoStation for connecting an air source to pre-installed, pre adjusted Vision ARF. Once this connection is made, turn on the air supply. The breadboard will float after a few minutes. Shipping screws need to be removed from each isolator. Each isolator has 2 shipping screws to secure it. See figure 11 for screw locations. Remove the screws.

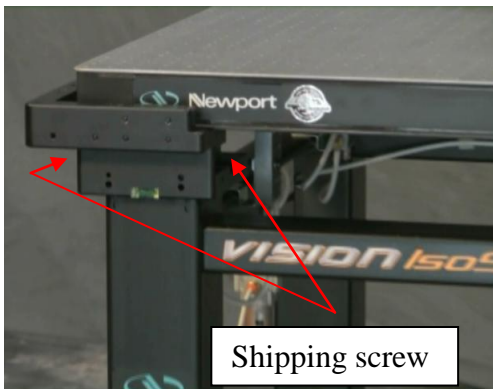

Figure 11 Shipping screw location – Each isolator has 2 shipping screws that will need to be removed in order to engage the horizontal leveling mechanism.

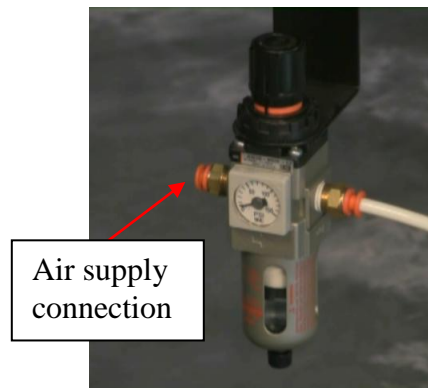

Figure 12 Vision IsoStation ARF and air compressor line connection

2.4 Adjusting Leveling Valve Sensors

After the system floats, check the position of the payload using the float height indicator. The bottom of the breadboard should be even with the float height indicator located on the corner block. Figures 11, 12 and 13 depict the cases of the breadboard floating too low, just right and too high respectively.

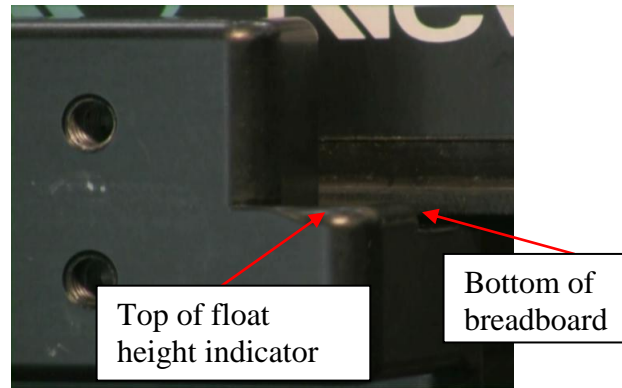

Figure 13 *The bottom of the breadboard is below the float height indicator. The leveling valve control arm screw should be rotated counter-clockwise.*

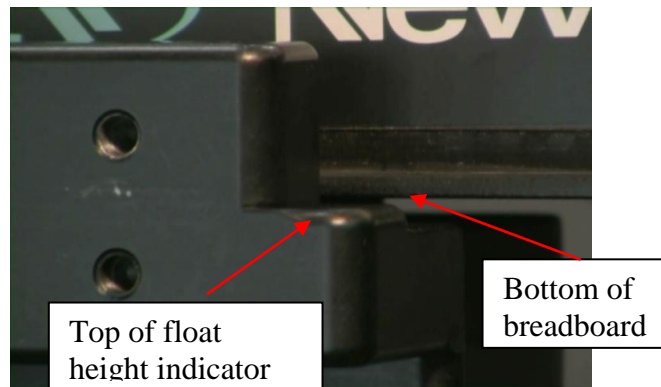

Figure 14 *The bottom of the breadboard is even with the float height indicator. The leveling valve control arm screw does not need adjustment*

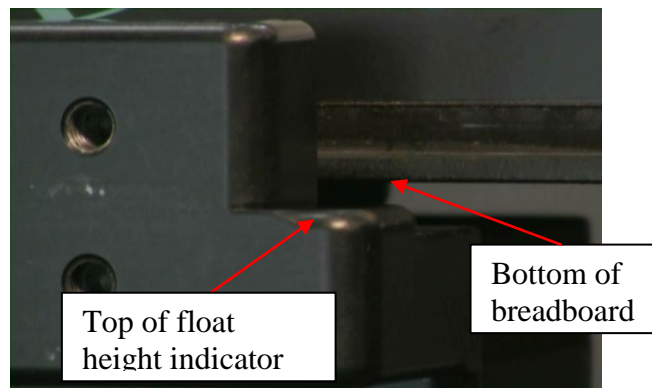

Figure 15 *The bottom of the breadboard is higher than the float height indicator. The leveling valve control arm screw should be rotated clockwise.*

8. Adjust the control arm adjustment screw of each valve (figure 16) as required to obtain alignment. When all isolators are adjusted, re-check

the level of the payload. NOTE: this step should require only minor adjustments. **Do not move the small set screw near the pivot of the valve control arm.**

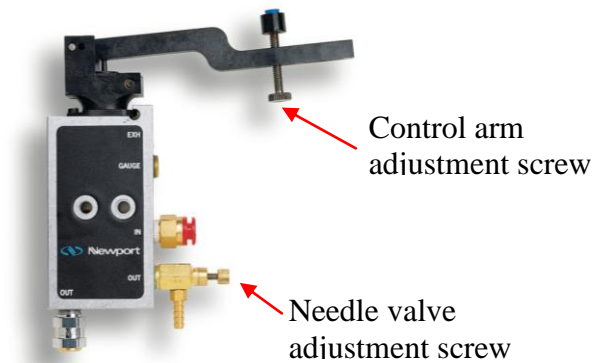









Figure 16 Leveling valve diagram

9. Verify that the breadboard is freely floating on the isolators. Move the breadboard gently from side-to-side about 1/8 inch. You should not encounter any resistance. Re-check by moving the breadboard up and down the same amount. Again, there should be no restriction of movement.
10. Push one corner of the breadboard down approximately 1/8" and release it. The breadboard should return to the original position within less than 4 seconds. Response time may be adjusted as described in Section 3.2.2.
11. If the breadboard rocks back and forth (oscillates vertically) without settling down close all of the needle valve adjustment screws. Then re-open the screw by 1/8 to 1/4 turn.
12. In each corner of the breadboard gently push down on the breadboard top. The breadboard should lower and then return to its starting position. Gently push up from the bottom of the breadboard. The breadboard should slightly rise then return to its original position. If the breadboard does not move freely either up or down adjust the height adjustment screws in the leveling valves until the breadboard moves freely.

2.5 Optional Accessories

The Vision IsoStation is compatible with a wide range of new Vision IsoStation accessories such as equipment shelves, monitor arms, a keyboard shelf, faraday cage, hip guard, and integrated accessory surfaces allowing you to put everything you need within arm's reach.. All of these new features and accessories have been designed specifically to improve ease-of - installation, set-up and lab space utilization. Below are the available accessories and model numbers. The accessories are field upgradable and can be ordered by the model numbers shown below.

	VIS-ATS-36 36" long Vision ATS shelf with electrical sockets VIS-ATS-48 48" long Vision ATS shelf with electrical sockets VIS-ATS-60 60" long Vision ATS shelf with electrical sockets VIS-ATS-72 72" long Vision ATS shelf with electrical sockets VIS-ATSE-36 36" long Vision ATS shelf, no electrical sockets VIS-ATSE-48 48" long Vision ATS shelf, no electrical sockets VIS-ATSE-60 60" long Vision ATS shelf, no electrical sockets VIS-ATSE-72 72" long Vision ATS shelf, no electrical sockets
	VIS-ESR-30 30" deep angled extension shelf, right side VIS-ESL-30 30" deep angled extension shelf, left side VIS-ESR-36 36" deep angled extension shelf, right side VIS-ESL-36 36" deep angled extension shelf, left side
	VIS-ES-24 24" deep straight extension shelf VIS-ES-30 30" deep straight extension shelf VIS-ES-36 36" deep straight extension shelf
	VIS-SCS-24 24" deep computer shelf VIS-SCS-30 30" deep computer shelf VIS-SCS-36 36" deep computer shelf
	VIS-HG-24 24" hip guard VIS-HG-30 30" hip guard VIS-HG-36 36" hip guard VIS-HG-48 48" hip guard VIS-HG-60 60" hip guard VIS-HG-72 72" hip guard

	<p>VIS-FPA VIS-KBA VIS-KBFP</p>	<p>Flat panel monitor arm Keyboard arm Keyboard and flat panel monitor arm kit</p>
	<p>VIS-FDC-2424 VIS-FDC-2436 VIS-FDC-3030 VIS-FDC-3036 VIS-FDC-3048 VIS-FDC-3636 VIS-FDC-3648 VIS-FDC-3660 VIS-FDC-3672</p>	<p>24"x24" Faraday cage, ring mounted 24"x36" Faraday cage, ring mounted 30"x30" Faraday cage, ring mounted 30"x36" Faraday cage, ring mounted 30"x48" Faraday cage, ring mounted 36"x36" Faraday cage, ring mounted 36"x38" Faraday cage, ring mounted 36"x60" Faraday cage, ring mounted 36"x72" Faraday cage, ring mounted</p>

2.6 Corner Block Mounting Hole Locations

The Vision IsoStation corner block has several holes that can be used to mount both Vision IsoStation accessories and user designed fixtures. The mounting hole locations and mounting hole type. All dimensions below are measured in inches. All of the holes are metric threads.

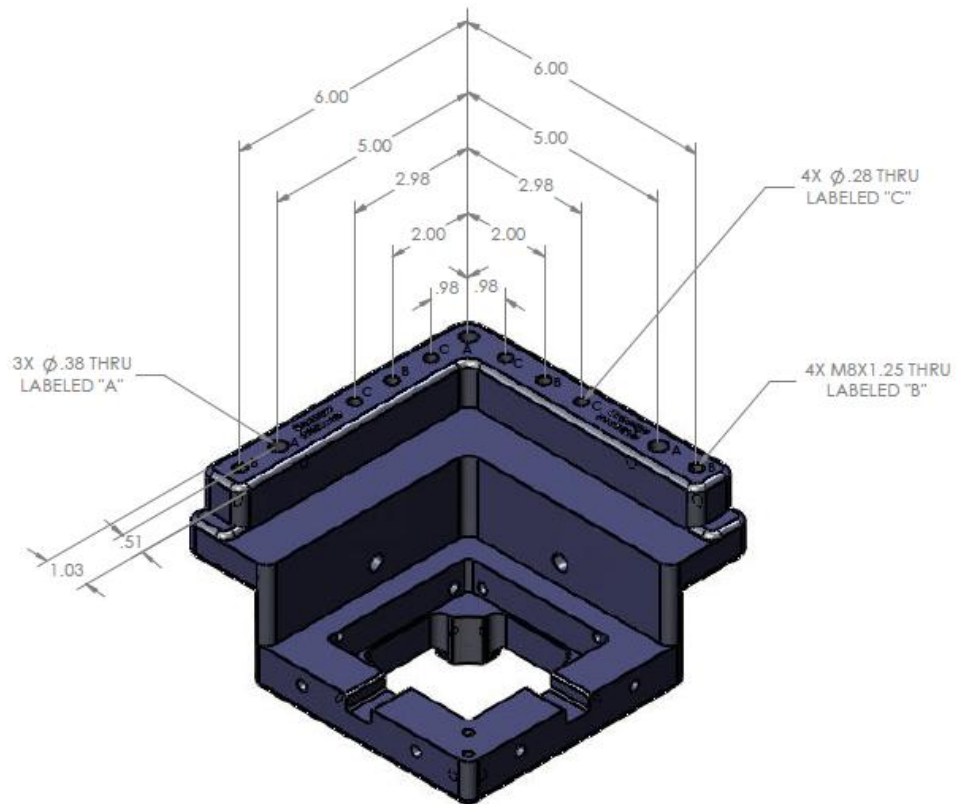

Figure 17 Corner block mounting hole locations

3 Section 3 – Operation

3.1 Principles of Operation

Newport Isolators provide one of the best methods of vibration isolation for critical applications. The system operates on the principle of air pistons, which are equivalent of soft springs. The main advantage of the Newport system over other designs are low vertical resonant frequency with low amplification at resonance (Q) and a Pendulum™ horizontal decoupling system for effective isolation from low amplitude vibration.

The leveling valves provided with the system control the height of the breadboard to within ± 0.01 inch (0.3mm) accuracy. This tolerance is adequate for most applications. More accurate valves are available for specialized applications.

3.2 Performance Adjustments

Once the system is assembled and floating, it is possible to make minor adjustments to suit your individual needs. These adjustments involve the system air pressure, the control arms, and needle valves.



WARNING

Once the system is floating, keep fingers away from the area between the corner pieces and the breadboard corners. Any object between these points may be caught if the load or air supply changes. Personal injury may result.

3.2.1 Stabilizing high center-of-mass loads

If your load has a high center of mass or if the load is particularly heavy, the system may oscillate. In this case, lower the air pressure or close the needle valves slightly. This may improve stability and reduce the oscillation or “hunting”.

A rule of thumb for determining high center of gravity (C-G) system stability is shown in Figure 17. If the combined center of gravity of the payload is within the “stable region”, the system will be stable. If the combined C-G is inside the “may be stable region”, the system may be stable. If the combined C-G is outside both regions, the system will probably be unstable.

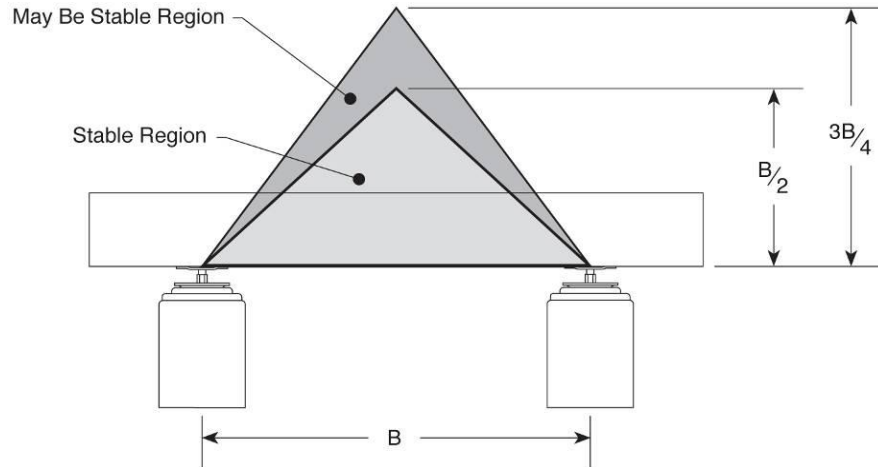

Figure 18 Stability Diagram

3.2.2 Improving leveling response times

If the system is stable, the re-leveling response time may be decreased by increasing the system pressure. In addition, the needle valves may be opened until the system oscillates and then closed slightly. This is desirable if components are moving over the surface of the breadboard.

For systems where the loads are seldom changed, slower re-leveling may be beneficial. This is accomplished by closing the needle valves slightly and/or decreasing the system pressure.

All needle valves should be opened the same amount for each isolator that they supply.

3.2.3 Breadboard loads and/or load positions change

If the loads are moving or changing significantly, the control arms may require adjustment. Each time the load is changed, check the relationship of the support plate to the top of each isolator. If the desired 1/4 inch is not maintained, adjust the overall system pressure and/or the sensor positions.

3.3 Maintenance

Newport Isolation Systems require little maintenance. No periodic maintenance is required.

3.3.1 Cleaning

Newport isolators are painted, powder coated, or zinc plated steel. This coated material is relatively corrosion resistant. It may be cleaned by applying non-abrasive liquid household cleaner to a rag and wiping the isolator. Avoid abrasive cleaners.

3.3.2 Air Quality

Oil, water, or debris in the air supply may contaminate the leveling valves or isolator damping system and degrade performance. Use of the Newport model ARF Air Regulator and Filter in the air supply will prevent this occurrence. The filter does require occasional cleaning.

4 Section 4 – Troubleshooting

4.1 System Does Not Float

Use the following procedure if the system does not float, when pressure is applied to the isolators.

1. Ensure that the supply pressure is 5–10 psig (0.4–0.7 kg/cm²) above the pressure reading of any of the leveling valves. If the load is increased, the pressure should be increased to maintain the difference between supply and valve pressure. Refer to Section 1.6.
2. Check to see if all air lines are connected properly and the supply pressure is adequate.
3. Be sure that the needle valves adjustment screws are not closed completely. See figure 16.
4. Check each leveling valve for clogging. To do this, press the control arm down. Air should flow into the isolator, accompanied by the familiar sound of moving air. Repair or replace any clogged valve. Use the ARF filter/regulator to prevent this situation.

4.2 Poor Isolation Performance

The following may lead to poor isolation performance of your system.

1. Vibration may be transmitted to the breadboard through direct physical contact of equipment with external sources of vibration including cables.
2. Isolators that float too high, too low, or are not centered may conduct floor vibration to the breadboard top. Centered isolators will remain centered unless the payload and isolators are moved relative to each other.
3. Equipment on the payload may be vibrating at a resonant frequency of other components. Improve the rigidity of the mounting for that equipment or remove that item from the system.
4. Air currents or pressure fluctuations may be disturbing components on the payload.

4.3 System Oscillates

If the system oscillates or “hunts”, you may have a set up with a high center of mass. Refer to the information in Section 3.2.1 or consult your Newport representative or Newport Corporation for further assistance.

4.4 System Leaks Air Constantly

All Newport isolators and valves are pressure leak tested prior to shipment. Check all tubing connections for leaks with soapy water. Tubing that is crushed out of round or that is not cut squarely may not seal in the push-in fittings. Use a single edge razor blade to cut the tubing cleanly. If testing with soapy water indicates that either the isolator or valve are leaking contact Newport Customer Service.

Section 5 – Factory Service

4.5 Obtaining Factory Service

To obtain information concerning factory service, contact Newport Corporation or your Newport representative. Please have the following information available.

1. Model number.
2. Purchase order number.
3. Complete description of the problem.

If components are to be returned to Newport Corporation, you will be given a Return Number, which you should reference in your shipping documents.

Please fill out the service form located on the next page, and have the information ready when contacting Newport Corporation. Include the completed service form with any parts or components that are returned.

5 Service Form

Vibration Control Products

Name

RETURN AUTHORIZATION #

Company

(Please obtain prior to return of item)

Address

Country

Date

P.O. Number

Phone Number

Item(s) Being Returned:

Model #

Serial # (or manufacturing date)

Description

Reason for return of goods (please list any specific problems)

Please Describe the Problem:

(Attach additional sheets as necessary)

Where is the Equipment Installed?

(factory, controlled laboratory, out-of-doors, etc.)

Maximum Air Pressure available?

Regulated? Yes No

Any additional information. (If special modifications have been made by the user, please describe below).

