

# Position Sensing Detector

Conex-PSD Series



The CONEX-PSD position sensing detectors provide accurate XY position information of laser beams and are ideally suited for laser beam stabilization, laser tracking and general beam diagnostics. Unlike quadrant detectors, the improved tetra-lateral effect diode of the CONEX-PSD is highly linear over the full sensor size, and delivers a third signal that is proportional to the beam power.

Compared to many detectors that are tweaked for high bandwidth, the CONEX-PSDs have been optimized for stability and compatibility with pulsed laser beams.

An analog input filters with 319 Hz (Si) and 136 Hz (Ge) cut-off frequencies suppress high frequency noise and undesired signal ringing when used with pulsed lasers. An additional digital low pass filter can be set by software in a frequency range from 0 Hz to 1000 Hz to further improve signal homogeneity.

The 883-OH adapter allows mounting additional optics in front of the detector for stray light reduction or beam attenuation. The CONEX-PSDs are post mountable with metric and imperial screw interfaces.

## Features and Benefits

- Measures laser beam position and power
- Sensor Size: 9 x 9 mm (Si), 10 x 10 mm (Ge)
- Wavelength Range: 320 - 1100 nm (Si), 800 - 1620 nm (Ge)
- Analog and adjustable digital filters to reduce noise
- Compatible with pulsed laser sources

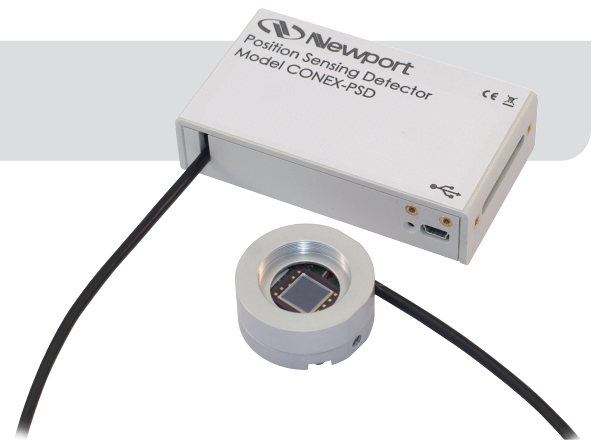

Specifications	CONEX-PSD9	CONEX-PSD10GE
Wavelength range	320–1100 nm	800-1620 nm
Sensor size	9 x 9 mm	10 x 10 mm
Peak responsivity	0.6 A/W @ 960 nm	0.85 A/W @ 1550 nm
Maximum photocurrent	500 µA (0.5 mA)	1000 µA (1.0 mA)
Recommended spot size	BSx = 9 mm – ΔX and BSY = 9 mm – ΔY	BSx = 10 mm – ΔX and BSY = 10 mm – ΔY
Minimum spot size	>0.2 mm	
A/D resolution	12 Bit	
Position sensitivity	1.5 µm at maximum power and with 20 Hz digital filter	5 µm at maximum power and with 20 Hz digital filter
Recommended power range	10–80% of max. power, see graph for details	
Computer interface	USB2.0, 1.8 m long USB-A to Mini-B cable included	
Programming	20+ intuitive, 2 letter ASCII commands	
Filters	Analog input filter, 319 Hz cut-off frequency, fixed	Analog input filter, 136 Hz cut-off frequency, fixed
	Digital low-pass filter, 0–1000 Hz, set by software	Digital low-pass filter, 0–1000 Hz, set by software
Status display	Two-color LED	
Input power requirements	Powered through USB interface	
Sensor Dimensions	38.1 mm diameter, 17.7 mm (H)	38.1 mm diameter, 22.9 mm (H)
Controller Dimensions	3.67" x 2.09" x 0.91" (93.2 x 53 x 23 mm)	
Cable length (detector to electronic)	1.6 ft (0.5 m)	

## Dimensional Drawing

### Silicon Sensor Dimensions (PSD9)

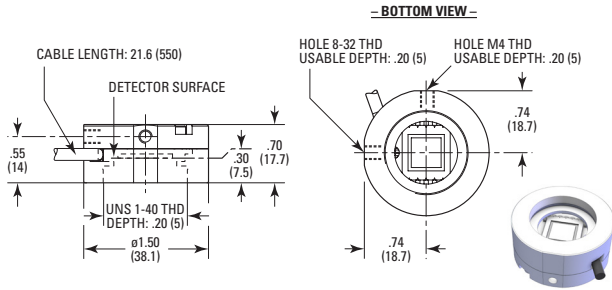

### Germanium Sensor Dimensions (PSD10GE)

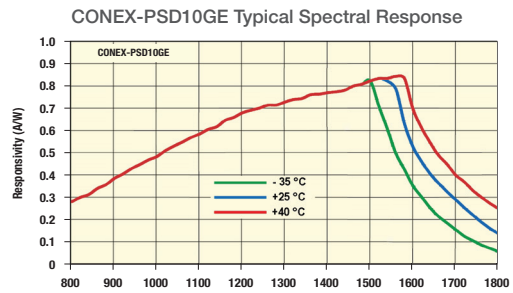
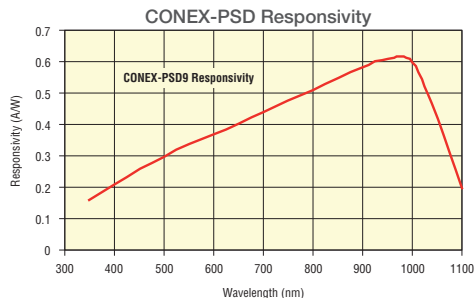
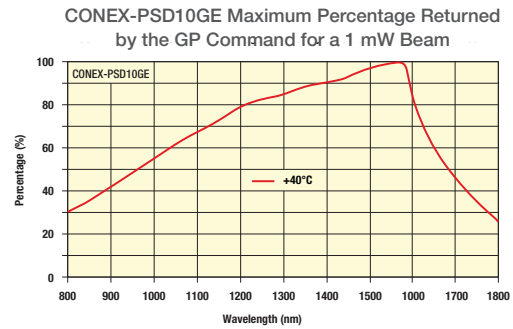
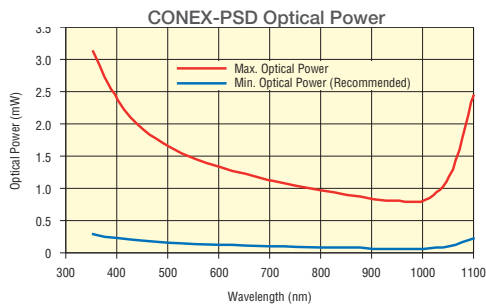
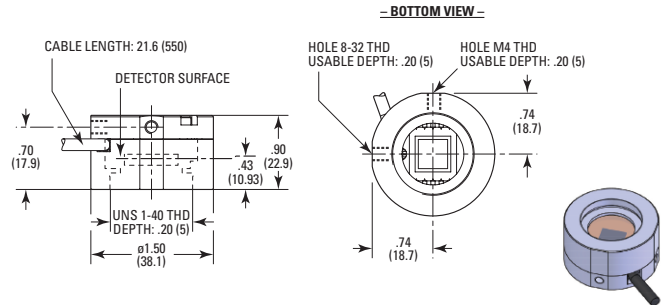

### Ordering Information

Model	Description
CONEX-PSD9	CONEX position sensing detector
883-OH	1" filter holder for CONEX-PSD9

### Ordering Information

Model	Description
CONEX-PSD10GE	CONEX position sensing detector
883-OH	1" filter holder for CONEX-PSD10GE