

NA = 0.6

EFL = 4.5 mm

CT = 2.94 mm

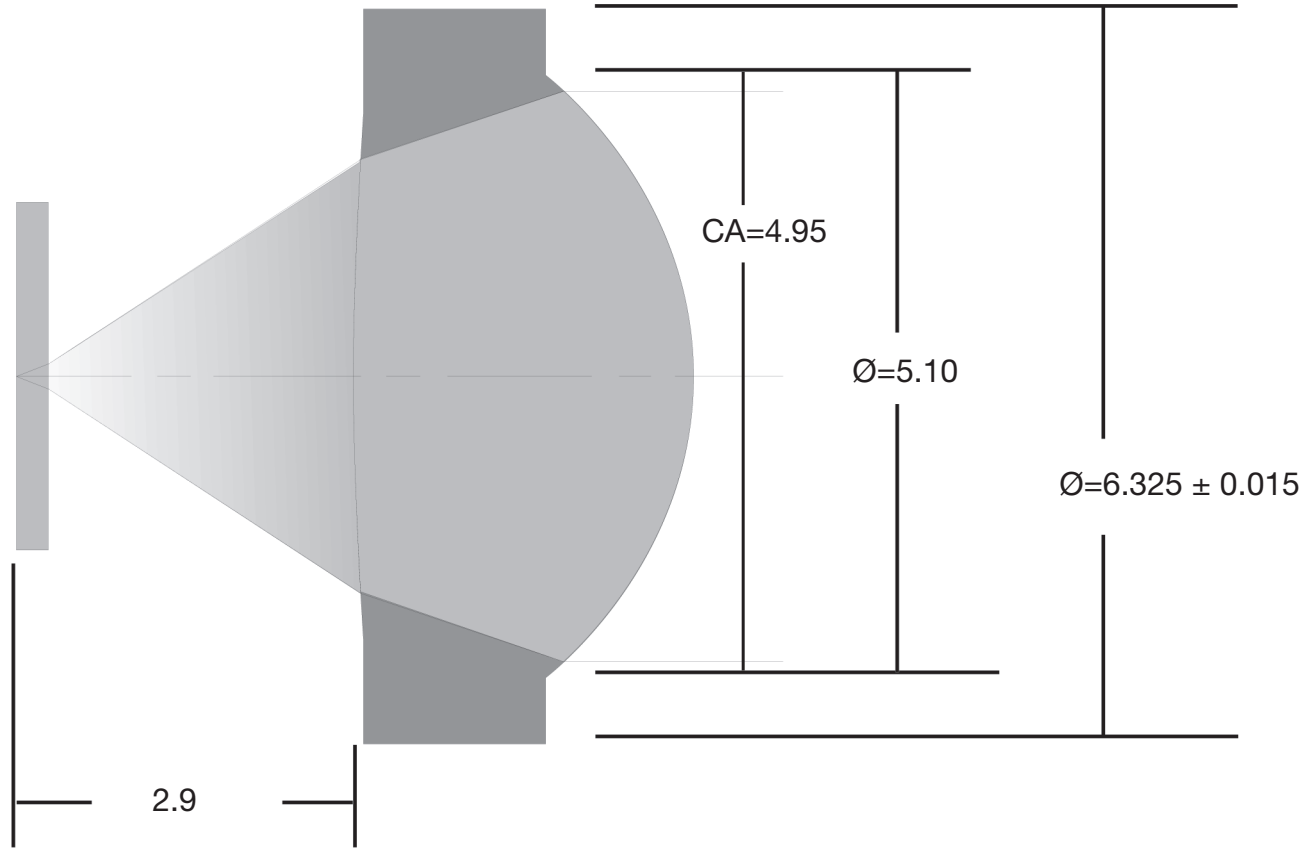

Dimensions in mm