

NA=0.5

EFL=4.5 mm

CT=3.45 mm

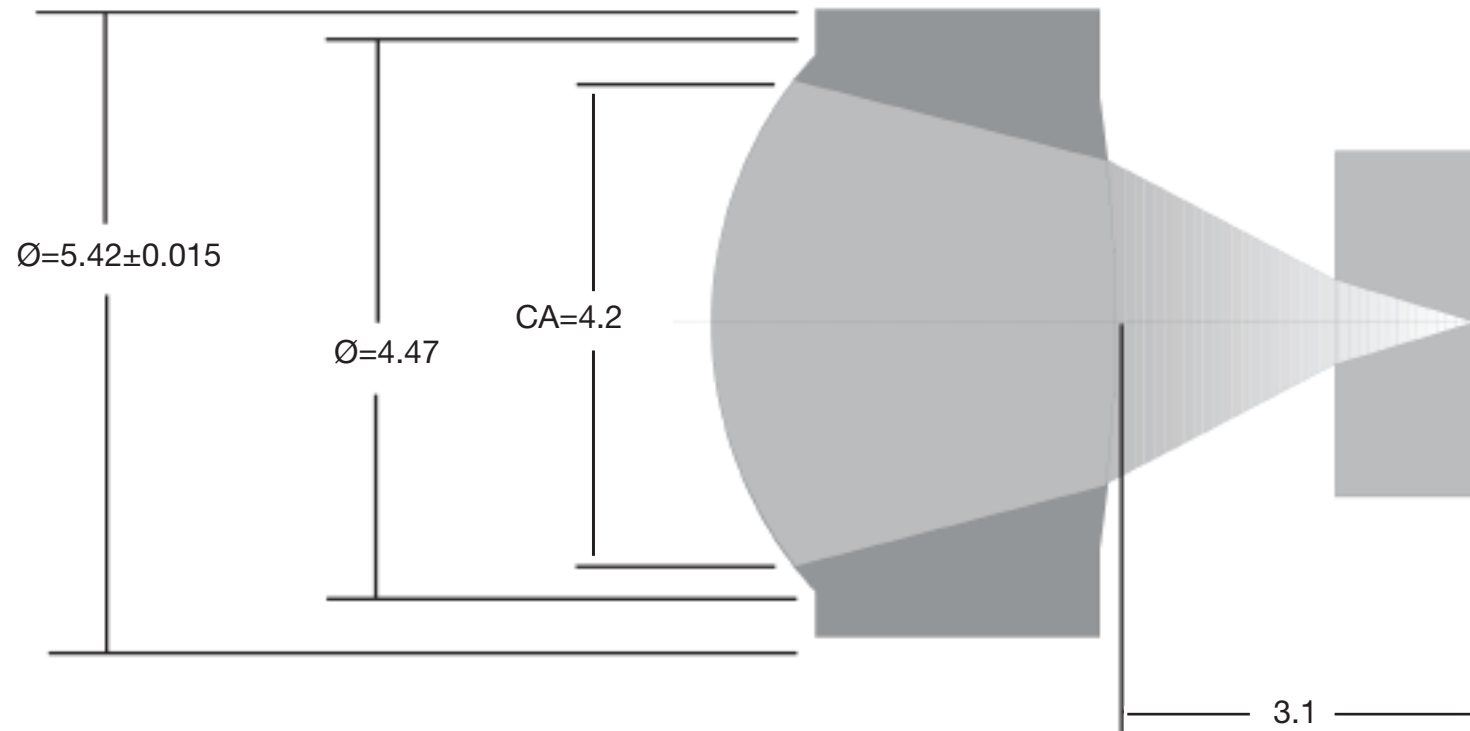

Dimensions in mm