

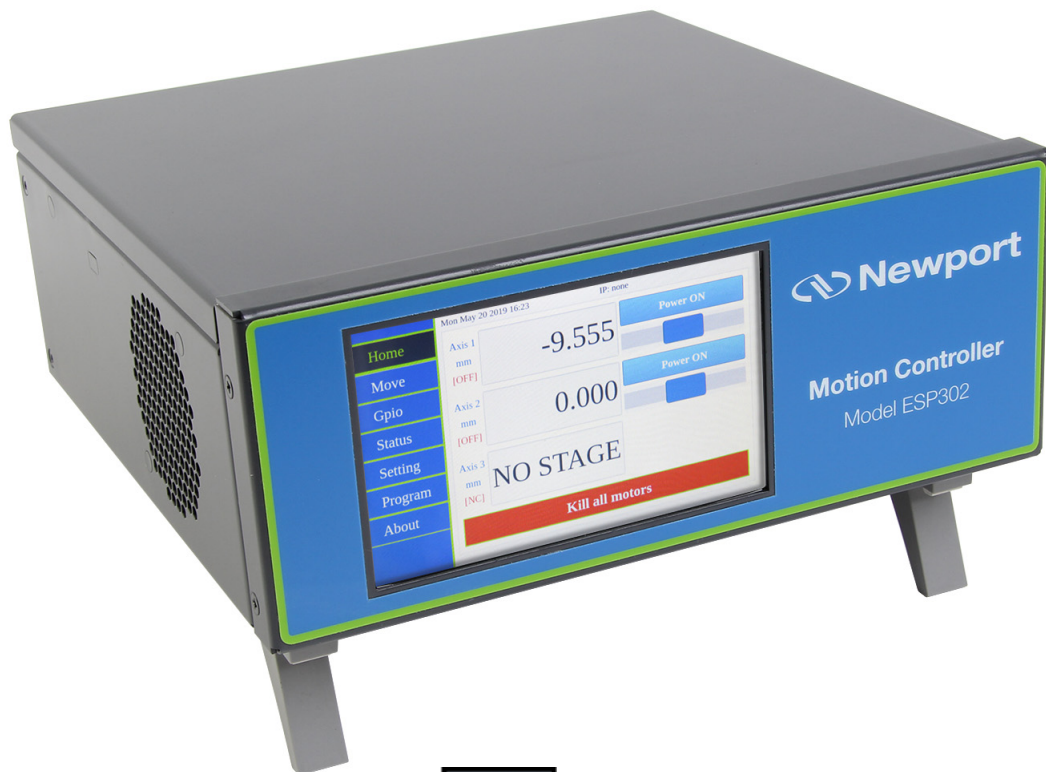

ESP302

Friendly Motion Controller/Driver



Start-Up Manual

Warranty

Newport Corporation warrants that this product will be free from defects in material and workmanship and will comply with Newport's published specifications at the time of sale for a period of one year from date of shipment. If found to be defective during the warranty period, the product will either be repaired or replaced at Newport's option.

To exercise this warranty, write or call your local Newport office or representative, or contact Newport headquarters in Irvine, California. You will be given prompt assistance and return instructions. Send the product, freight prepaid, to the indicated service facility. Repairs will be made and the instrument returned freight prepaid. Repaired products are warranted for the remainder of the original warranty period or 90 days, whichever occurs last.

Limitation of Warranty

The above warranties do not apply to products which have been repaired or modified without Newport's written approval, or products subjected to unusual physical, thermal or electrical stress, improper installation, misuse, abuse, accident or negligence in use, storage, transportation or handling.

THIS WARRANTY IS IN LIEU OF ALL OTHER WARRANTIES, EXPRESSED OR IMPLIED, INCLUDING ANY IMPLIED WARRANTY OF MERCHANTABILITY OR FITNESS FOR A PARTICULAR USE. NEWPORT CORPORATION SHALL NOT BE LIABLE FOR ANY INDIRECT, SPECIAL, OR CONSEQUENTIAL DAMAGES RESULTING FROM THE PURCHASE OR USE OF ITS PRODUCTS.

©2019 by Newport Corporation, Irvine, CA. All rights reserved.

Original instructions.

No part of this document may be reproduced or copied without the prior written approval of Newport Corporation. This document is provided for information only, and product specifications are subject to change without notice. Any change will be reflected in future publishings.

Table of Contents

	Waranty.....	ii
	EU Declaration of Conformity.....	vi
	Preface	vii
<hr/>		
1.0	Introduction	1
1.1	Scope of the Manual	1
1.3	Definitions and Symbols.....	2
1.3.1	General Warning or Caution	2
1.3.2	Electric Shock	2
1.3.3	European Union CE Mark.....	2
1.3.4	“ON” Symbol.....	2
1.3.5	“OFF” Symbol	2
1.3.6	Protective Earth Symbol	3
1.4	Warning, Caution and Note Definition	3
1.5	General Warnings and Cautions.....	3
<hr/>		
2.0	System Overview	5
2.1	Specifications	5
2.2	Drive Options.....	6
2.3	Compatible Newport Positioners	6
2.4	Front Panel Description	7
2.5	Rear Panel Description.....	7
2.5.1	Axis Connectors (AXIS 1 – AXIS 3).....	8
2.6	Ethernet Configuration.....	8
2.6.1	Communication Protocols.....	8
2.6.2	Addressing	8
2.7	Sockets, Multitasking and Multi-user Applications	9
<hr/>		
3.0	Getting Started	10
3.1	Unpacking and Handling	10
3.2	Inspection for Damage	10
3.3	Packing List	10
3.4	System Setup.....	10
3.4.1	Rack Mounting Kit.....	11
3.4.2	Connecting to the Main.....	13
3.4.3	Power ON.....	13
3.5	Operation	13
3.6	Connecting to the ESP302 through COMM. port	14

3.7	Connecting to the ESP302 through Ethernet port	14
3.7.1	Direct Connection to the ESP302 Controller	15
3.7.2	Connecting the ESP302 to a Corporate Network Using Static IP Configuration	18
3.7.3	Configuring the ESP302 for Connection to a Corporate Network Using Dynamic IP Configuration	20
3.7.4	Recovering a Lost IP Configuration.....	22
3.7.5	Testing your ESP302-PC Connection and Communication.....	23
3.8	Connecting the Stages.....	24
3.9	Configuring the Controller.....	24
3.9.1	Dummy Stages	25
3.9.2	Configuration files	25
3.10	Using the controller.....	26
3.11	Documentation.....	26
3.12	SFTP (Secured File Transfer Protocol) Connection.....	27
3.13	Samba Microsoft SMB/CIFS Networking Protocol.....	28
3.14	System Shut-Down	28
4.0	Maintenance and Service.....	29
4.1	Enclosure Cleaning	29
4.2	Obtaining Service.....	29
4.3	Troubleshooting	29
5.0	Appendix A: Hardware.....	30
5.1	Controller	30
5.2	Rear Panel Connectors	31
6.0	Appendix B: General I/O Description	32
6.1	Digital I/O's	32
6.1.1	GPIO Connector.....	32
6.2	Axes	33
6.2.1	Digital Encoder Inputs	33
6.2.2	Digital Servitudes.....	33
6.2.3	Axis Connectors	33
6.3	Communication Port	35
6.3.1	COMM. Connector	35
7.0	Appendix C: Power Inhibit Connector	36
7.1	Description.....	36
	Service Form	37

EU Declaration of Conformity



EU Declaration of Conformity

Application of Council Directive(s): 2014/30/EU Electromagnetic Compatibility Directive (EMCD)
 2014/35/EU Low Voltage Directive (LVD)
 2014/68/EU European Pressure Equipment Directive (PED)
 2011/65/EU Restriction of Hazardous Substances Directive (RoHS)

Standard(s) to which conformity is declared: EN 61326-1:2013 (EMC); EN 61326-2-3:2013 (EMC);
 EN 61010-1:2010 (Safety);
 PED Module SEP (Sound Engineering Practices); 2014

Emissions:

CISPR 11:2015 Industrial, Scientific and Medical Equipment Radio-Frequency Disturbance Characteristics - Limits and Methods of Measurement
 IEC 61000-3-2:2014 EMC/Limits for Harmonic Current Emission ⁽¹⁾
 IEC 61000-3-3:2013 EMC/Limitations of Voltage Fluctuations and Flicker in Low-Voltage Supply Systems ⁽²⁾
 IEC 61000-3-3:2013 EMC/Limitations of Voltage Fluctuations and Flicker in Low-Voltage Supply Systems ⁽³⁾
 EN 55011: 2009+A1:2010 ⁽⁴⁾
 FCC 47 CFR Part 18: 2015

Immunity:

IEC 61000-4-2:2008 EMC/Electrostatic Discharge Immunity Test
 IEC 61000-4-3:2006 2006+AMD1:2007+AMD2:2010 EMC/Radiated Radio - Frequency Electromagnetic Field Immunity Test
 IEC 61000-4-4:2012 EMC/Electrical Fast Transient/Burst Immunity Test
 IEC 61000-4-5:2014 EMC/Surge Immunity Test ⁽³⁾
 IEC 61000-4-6:2013 EMC/Conducted Disturbances induced by Radio Frequency Fields Immunity Test
 IEC 61000-4-8:2009 EMC/Power Frequency Magnetic Field Immunity Test
 IEC 61000-4-11:2004 EMC/Voltage Dips, Short Interruptions and Variations Immunity Test ⁽⁵⁾
 IEC 61000-4-34:2005+AMD1:2009 EMC/Voltage Dips, Short Interruptions and Variations Immunity Test ⁽⁵⁾

Manufacturers Name: MICRO-CONTROLE Spectra-Physics. EVRY, France.

Importer's Name & Location: /

Equipment Type/Description: **Motion Controller/Driver**

Model Number(s) ⁽⁶⁾: **ESP302**

MKS confirms that, with respect to the products listed above, it believes it is in conformity with the selected European Union harmonization legislation. MKS product conforms to the above Directive(s) and Standard(s) only when installed in accordance with manufacturer's specifications. This declaration has been issued under the sole responsibility of the manufacturer.

Date: 01/31/2019

Le Cointe Hervé
Quality Director

- 1) Applicable to AC powered product only. Class B
- 2) Applicable to AC powered product; DC powered connections must not connect to a D.C. distribution network; I/O Signal and Control Lines must be less than 30m and not exit the building.
- 3) Applicable to AC powered product; DC powered connections and may connect to a D.C. distribution network.
- 4) Class A, Group 2
- 5) Applicable to AC powered product only.
- 6) Compliance of the above model numbers requires the use of a braided shielded cable properly terminated at both ends – if so noted in the MKS Instruction Manual.

Preface

Confidentiality & Proprietary Rights

Reservation of Title

The Newport Programs and all materials furnished or produced in connection with them ("Related Materials") contain trade secrets of Newport and are for use only in the manner expressly permitted. Newport claims and reserves all rights and benefits afforded under law in the Programs provided by Newport Corporation.

Newport shall retain full ownership of Intellectual Property Rights in and to all development, process, align or assembly technologies developed and other derivative work that may be developed by Newport. Customer shall not challenge, or cause any third party to challenge, the rights of Newport.

Preservation of Secrecy and Confidentiality and Restrictions to Access

Customer shall protect the Newport Programs and Related Materials as trade secrets of Newport, and shall devote its best efforts to ensure that all its personnel protect the Newport Programs as trade secrets of Newport Corporation. Customer shall not at any time disclose Newport's trade secrets to any other person, firm, organization, or employee that does not need (consistent with Customer's right of use hereunder) to obtain access to the Newport Programs and Related Materials. These restrictions shall not apply to information (1) generally known to the public or obtainable from public sources; (2) readily apparent from the keyboard operations, visual display, or output reports of the Programs; (3) previously in the possession of Customer or subsequently developed or acquired without reliance on the Newport Programs; or (4) approved by Newport for release without restriction.

Sales, Tech Support & Service

North America & Asia

Newport Corporation
1791 Deere Ave.
Irvine, CA 92606, USA

Sales

Tel.: (800) 222-6440
e-mail: sales@newport.com

Technical Support

Tel.: (800) 222-6440
e-mail: tech@newport.com

Service, RMAs & Returns

Tel.: (800) 222-6440
e-mail: service@newport.com

Europe

MICRO-CONTROLE Spectra-Physics S.A.S
9 rue du bois sauvage
91055 Évry CEDEX
France

Sales France

Tel.: +33 (0)1.60.91.68.68
e-mail: france@newport.com

Sales Germany

Tel.: +49 (0) 61 51 /708 – 0
e-mail: germany@newport.com

Sales UK

Tel.: +44 (0)1635.521757
e-mail: uk@newport.com

Technical Support

e-mail: tech_europe@newport.com

Service & Returns

Tel.: +33 (0)2.38.40.51.55

Service Information

The user should not attempt any maintenance or service of the ESP302 Series Controller/Driver system beyond the procedures outlined in this manual. Any problem that cannot be resolved should be referred to Newport Corporation. When calling Newport regarding a problem, please provide the Tech Support representative with the following information:

- Your contact information.
- System serial number or original order number.
- Description of problem.
- Environment in which the system is used.
- State of the system before the problem.
- Frequency and repeatability of problem.
- Can the product continue to operate with this problem?
- Can you identify anything that may have caused the problem?

Newport Corporation RMA Procedures

Any ESP302 Series Controller/Driver being returned to Newport must be assigned an RMA number by Newport. Assignment of the RMA requires the item's serial number.

Packaging

ESP302 Series Controller/Driver being returned under an RMA must be securely packaged for shipment. If possible, re-use the original packaging.

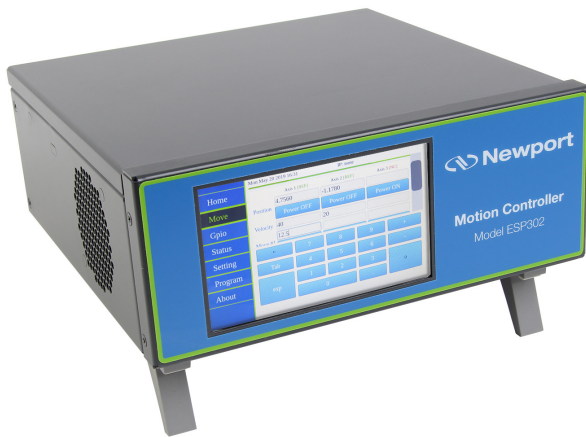

Friendly Motion Controller/Driver ESP 302 Controller

1.0 Introduction

1.1 Scope of the Manual

The ESP302 is an advanced stand-alone, easy to use, motion controller with up to 3 integrated motor drivers and outstanding powerful programming functionality.

It offers different operating modes through its user-friendly touchscreen front panel, command remote ports, and web interface offering high-speed communication through 10/100/1000 Base-T Ethernet.

The ESP302 provides advanced trajectory and synchronization features to precisely control from the most basic to the most complex motion sequences. Multiple digital triggers provide users with additional synchronization and control features that can improve the most demanding motion applications.

The Enhanced System Performance (ESP) architecture consists of ESP-compatible controllers and stages. When used with ESP-compatible stages, the ESP302 plug-and-play concept significantly increases user friendliness and improves overall motion performance.

To maximize the value of the ESP302 Controller/Driver system, it is important that users become thoroughly familiar with available documentation.

The present **ESP302 Start-Up Manual** is delivered as a hard copy with the controller.

The ESP302 Start-Up Manual, User Interface Manual, Features Manual, Programmer's Manual are PDF files accessible from the controller disk which can be downloaded from the controller website under the tab Documentation.

.NET assemblies and corresponding sources are available from the controller website under the tab Documentation -> Drivers.

1.3 Definitions and Symbols

The following terms and symbols are used in this documentation and also appear on the ESP302 Series Controller/Driver where safety-related issues occur.

1.3.1 General Warning or Caution



Figure 1: General warning or caution symbol.

The Exclamation Symbol in Figure 1 may appear in Warning and Caution tables in this document. This symbol designates an area where personal injury or damage to the equipment is possible.

1.3.2 Electric Shock



Figure 2: Electrical shock symbol.

The Electrical Shock Symbol in Figure 2 may appear on labels affixed to the ESP302 Series Controller/Driver. This symbol indicates a hazard arising from dangerous voltages. Any mishandling could result in damage to the equipment, personal injury, or even death.

1.3.3 European Union CE Mark



Figure 3: CE mark.

The presence of the CE Mark on Newport Corporation equipment means that it has been designed, tested and certified to comply with all current and applicable European Union (CE) regulations and recommendations.

1.3.4 “ON” Symbol



Figure 4: “ON” symbol.

The “ON” Symbol in Figure 4 appears on the power switch of the ESP302 Series Controller/Driver. This symbol represents the “Power On” condition.

1.3.5 “OFF” Symbol



Figure 5: “OFF” symbol.

The “Off” Symbol in Figure 5 appears on the power switch of the ESP302 Series Controller/Driver. This symbol represents the “Power Off” condition.

1.3.6 Protective Earth Symbol



Figure 6: Protective Earth symbol.

The Protective Earth Symbol in Figure 6 appears next to the ground stud at the rear of the ESP302 Series Controller/Driver.

1.4 Warning, Caution and Note Definition

The following are definitions of the Warnings, Cautions and Notes that may be used in this manual to call attention to important information regarding personal safety, safety and preservation of the equipment, or important tips.



WARNING

Situation has the potential to cause bodily harm or death.



CAUTION

Situation has the potential to cause damage to property or equipment.

NOTE

Additional information the user or operator should consider.

1.5 General Warnings and Cautions

The following general safety precautions must be observed during all phases of operation of this equipment.

Failure to comply with these precautions or with specific warnings elsewhere in this manual violates safety standards of design, manufacture, and the intended use of the equipment.

- Only properly trained personnel should use this device
- Heed all warnings on the unit and in the operating instructions.
- To prevent damage to the equipment, read the instructions in this manual for the selection of the proper input voltage.
- Use only the main cable provided with this product and certified for the country of use.
- Ensure that the equipment is properly grounded to earth through the grounding lead of the AC main cable.
- Route cables where they are not likely to be damaged.
- Keep permanent access to the wall inlet or to the main switching device.
- The system must be installed in such a way that the power switch and the power connector at the rear remain accessible to the user.
- Disconnect or do not plug-in the AC power cord under the following conditions:
 - If the AC power cord or any other attached cables are frayed or damaged.
 - If the power plug or receptacle is damaged.
 - If the unit is exposed to rain or excessive moisture, or liquids are spilled on it.
 - If the unit has been dropped or the case is damaged.

- If the user suspects service or repair is required.
- Keep air vents free of dirt and dust and obstructions.
- Keep liquids away from unit.
- Do not expose equipment to moisture exceeding specification.
- Do not operate this equipment in an explosive atmosphere.
- Disconnect power before cleaning the Controller/Driver unit. Do not use liquid or aerosol cleaners.
- Do not open the ESP302 Controller/Driver stand-alone motion controller. There are no user-serviceable parts inside the ESP302 Controller/Driver.
- Return equipment to Newport Corporation for service and repair.
- Dangerous voltages associated with the power supply are present inside Controller/Driver unit. To avoid injury, do not touch exposed connections or components while power is on.

WARNING

This product is equipped with a 3-wire grounding type plug. Any interruption of the grounding connection can create an electric shock hazard. If you are unable to insert the plug into your wall plug receptacle, contact an electrician to perform the necessary alterations to ensure that the green (green-yellow) wire is attached to earth ground.

System earthing must be of type earthed neutral (TN-) as defined by CEI60364.

2.0 System Overview

2.1 Specifications

Number of Axes	<ul style="list-style-type: none"> • 1 to 3 axes of stepper or DC brush motors using internal drives
Communication Interfaces	<ul style="list-style-type: none"> • COMM. port (RS232) • Front panel touchscreen interface • Ethernet TCP/IP 10/100/1000 Base-T: <ul style="list-style-type: none"> – One RJ45 connector with fixed IP address and DHCP server for local communication – One RJ45 connector for networking, static or dynamic addressing with DHCP and DNS
Firmware Features	<ul style="list-style-type: none"> • Native user defined units (no need to program in encoder counts) • Real time execution of custom tasks using program mode • Multi-user capability • Concept of sockets for parallel processes • Data gathering at up to 10 kHz rate
Motion	<ul style="list-style-type: none"> • Jogging mode including on-the fly changes of speed and acceleration • Line and arc modes for two axes trajectory motions • Master-slave including single master-multiple slaves and custom gear ratio
Compensation	<ul style="list-style-type: none"> • Backlash • Linear (All corrections are taken into account on the servo loop)
Servo Rate	<ul style="list-style-type: none"> • Fixed at 10 kHz
I/O	<ul style="list-style-type: none"> • 16 TTL 5 V configurable as inputs or outputs
Control Loop	<ul style="list-style-type: none"> • Open loop, PI position, PIDFF velocity, PIDDualFF voltage • Integration limit and integration time • Derivative cut-off filter
Trigger In	<ul style="list-style-type: none"> • GPIO configurable to start/inhibit motion, jog or program execution
Dedicated Inputs Per Axis	<ul style="list-style-type: none"> • RS-422 differential inputs for A, B and I, Max. 25 MHz • Mechanical zero and limits
Drive Capability	<ul style="list-style-type: none"> • Voltage, velocity (for DC brush motor control). • Position (for stepper motor control) • 2x3A RMS @ 48V per axis • 150 W (@ 230 VAC) maximum available power for all axes
AC Power Requirements	<ul style="list-style-type: none"> • 100–240 VAC 60/50 Hz 4.8 A–2.1 A. The controller should be connected to a power installation that incorporates appropriate protection devices. Refer to the installation requirements of your facility and local applicable Standards
Environmental Condition	<ul style="list-style-type: none"> • Internal use
Overvoltage Category	<ul style="list-style-type: none"> • Category II (2500 V max transient surges)
Operating Temperature	<ul style="list-style-type: none"> • +5 °C to +40 °C
Humidity	<ul style="list-style-type: none"> • 85% R.H. at 40 °C (Non-condensing)
Pressure	<ul style="list-style-type: none"> • Atmospheric pressure
Storage Temperature	<ul style="list-style-type: none"> • -20 °C to +55 °C (Non-condensing)
Pollution	<ul style="list-style-type: none"> • Pollution Degree 2, exempt of conducting dust
Transport Temperature	<ul style="list-style-type: none"> • -20 °C to +70 °C (Non-condensing)

2.2 Drive Options

The ESP302 controller is capable of driving up to 3 axes of most Newport positioners using driver cards. These factory-tested drives are powered by an internal 200 W power supply with 150 W for motion and 50 W for controller.

When used with Newport ESP stages, the configuration of the driver cards is easy using the auto-configuration utility software.

The motor drive has the capability to drive bipolar stepper motors in microstep mode (sine/cosine commutation)

The motor drive has been optimized for use with high-performance DC motors. It is capable of driving DC motors in voltage mode and in current mode. All parameters are programmable in physical units. Furthermore, the motor drive features individual limits for the RMS current and the peak current.

2.3 Compatible Newport Positioners

The list of all compatible Newport positioners is available from the Newport catalog or at <https://www.newport.com/n/stage-and-controller-compatibility>

2.4 Front Panel Description



Figure 7: Front panel of ESP302 Controller/Driver.

The ESP302 front panel includes a 5" touchscreen for operation in LOCAL mode.

2.5 Rear Panel Description

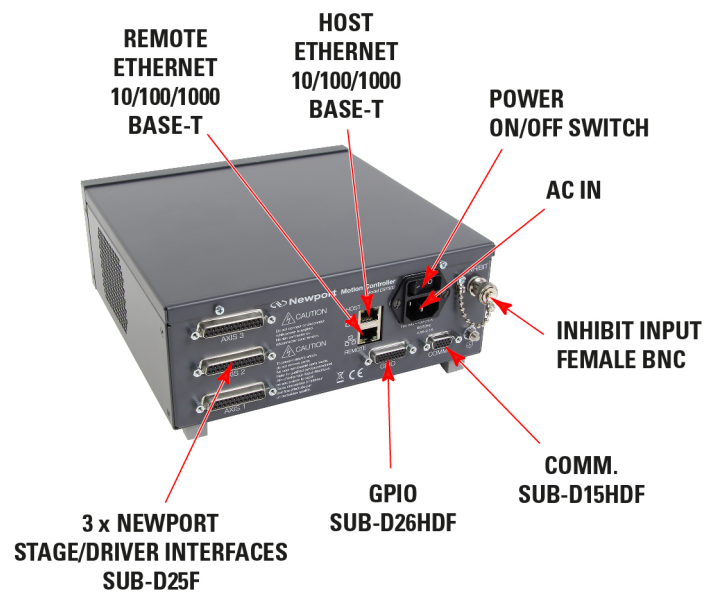

Figure 8: Rear panel of ESP302 Controller/Driver.

NOTE

The Main Power ON/OFF Switch is located next to the inlet for the power cord. The switch and the inlet must be accessible to the user.

2.5.1 Axis Connectors (AXIS 1 – AXIS 3)

Each installed axis driver card features a SUB-D25F connector to attach a cable (supplied with every Newport stage) between the controller and a motion device.



Figure 9: Axis connectors.

Please see the next section for installation instructions.

2.6 Ethernet Configuration

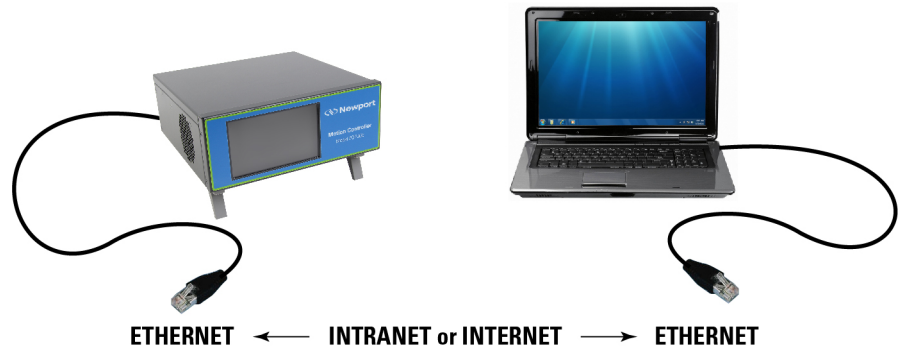

Figure 10: Ethernet configuration.

2.6.1 Communication Protocols

The Ethernet connection provides a local area network through which information is transferred in units known as packets. Communication protocols are necessary to dictate how these packets are sent and received. The ESP302 Controller/Driver supports the industry standard protocol TCP/IP.

TCP/IP is a “connection” protocol and in this protocol, the master must be connected to the slave in order to begin communication. Each packet sent is acknowledged when received. If no acknowledgement is received, the information is assumed lost and is resent.

2.6.2 Addressing

There are two levels of addresses that define Ethernet devices. The first is the MAC address. This is a unique and permanent 6 byte number. No other device will have the same MAC address. The second level of addressing is the IP address. This is a 32-bit (or 4 byte) number. The IP address is constrained by each local network and must be assigned locally. Assigning an IP address to the controller can be done in a number of ways (see section 3.6: “Connecting to the ESP302 through Ethernet port”).

2.7 Sockets, Multitasking and Multi-user Applications

Based on the TCP/IP Internet communication protocol, the ESP302 controller has a high number of virtual communication ports, known as sockets. To establish communication, the user must first request a socket ID from the ESP302 controller server (listening at a defined IP number and port number).

The concept and application of sockets has many advantages. First, users can split their application into different segments that run independently on different threads or even on different computers.

Second, the concept of sockets has another practical advantage for many laboratory users since the use of threads allows them to share the same controller for different applications at the same time. With the ESP302, it is possible that one axis of the ESP302 controller for an optical delay line, while another axes are simultaneously used for a totally different application. Both applications could run completely independent from different workstations without any delays or cross-talk.

3.0 Getting Started

3.1 Unpacking and Handling

It is recommended that the ESP302 Controller/Driver be unpacked in your lab or work site rather than at the receiving dock. Unpack the system carefully; several cables are included with the equipment. Inspect the box carefully for loose parts before disposing of the packaging. You are urged to save the packaging material in case you need to ship your equipment.

3.2 Inspection for Damage

ESP302 Controller/Driver has been carefully packaged at the factory to minimize the possibility of damage during shipping. Inspect the box for external signs of damage or mishandling. Inspect the contents for damage. If there is visible damage to the equipment upon receipt, inform the shipping company and Newport Corporation immediately.

WARNING



Do not attempt to operate this equipment if there is evidence of shipping damage or you suspect the unit is damaged. Damaged equipment may present additional personnel hazard. Contact Newport technical support for advice before attempting to plug in and operate damaged equipment.

3.3 Packing List

Included with each ESP302 controller/driver are the following items:

- Power cord.
- Straight-through Ethernet cable, black, 5 meters.
- ESP302 Start-Up Manual.

If there are missing hardware or have questions about the hardware that were received, please contact Newport.

3.4 System Setup

This section guides the user through the proper set-up of the motion control system. If not already done, carefully unpack and visually inspect the controller and stages for any damage. Place all components on a flat and clean surface.

WARNING



Before operating the ESP302 controller, please read chapter 1.0 very carefully.

CAUTION



The ESP302 controller includes several protections against wiring and configuration errors. However, attempting to operate with wrong connections or parameters may lead to material damage.

CAUTION



No cables should be connected to the controller at this point!

3.4.1 Rack Mounting Kit

The ESP302 controller is basically intended to be installed on a flat surface such as a table or a cabinet shelf.

A rack mounting kit can be provided separately to properly secure the controller in a standard 19" electronic enclosure. It is composed of two brackets and handles that can be easily attached on the sides of the controller. Both orientation mountings are possible as shown below.

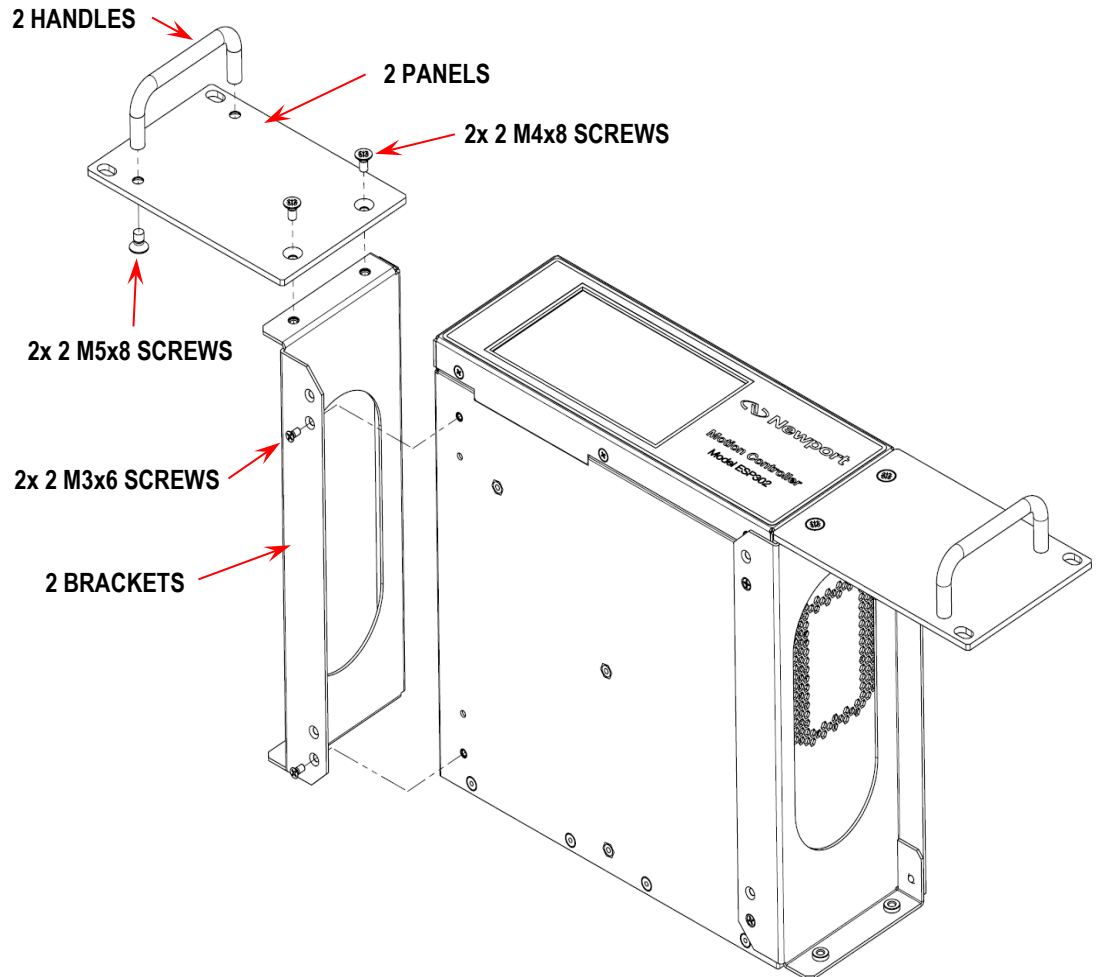

Figure 11: Front rack mounting.

3.4.2 Connecting to the Main

- If desired, a second protective earth line can optionally be connected to the M5 ground stud at the rear of the controller (tighten the nut at 0.5 N.m).
- The line current must be limited by a 16A fuse or circuit breaker and it must be protected according applicable standards.
- The controller must be installed in such a way that power switch and power connector are accessible by the user.
- Verify ON/OFF switch is turned off
- Plug the AC line cord into the AC power receptacle on the rear panel.
- Plug the AC line cord into the AC wall-outlet.

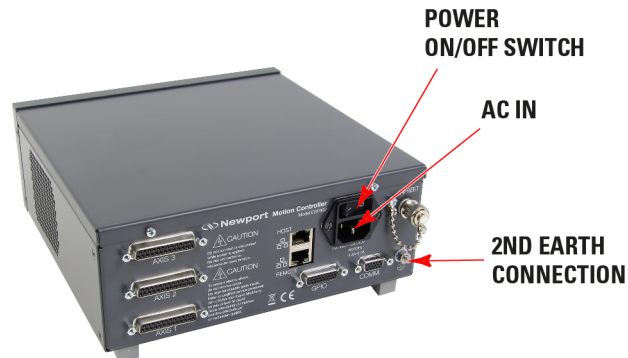

Figure 13: Earth & AC line connections.



WARNING

The AC mainline must include a protective earth.

NOTE

Power Input: 100–240 V, 60/50 Hz, 4.8–2.1A

3.4.3 Power ON

- Turn the Main Power Switch to ON (located on the Rear Panel).
- There is also an Inhibit switch entry with a BNC connector at the rear of the ESP302. An external Inhibit switch can be directly linked by hardware to cut off motor power supply. Refer to section 7.0 for further details on Inhibit connector. If no cable is connected, let the plug in place.

3.5 Operation

ESP302 controller/driver can be operated in three different modes:

- **LOCAL mode** using the front panel touchscreen.
- **REMOTE mode** by sending commands with a terminal emulator (Telnet on port 5001) or the .NET library through one of the REMOTE and HOST Ethernet ports, or through the COMM port.
- **WEB INTERFACE mode** using the controller website through one of the REMOTE and HOST Ethernet ports.

Refer to the **ESP302 User Interface Manual** for front panel and website interfaces description and to **Programmer's Manual** for detailed remote commands description.

The different types of connection with a computer are described further.

3.6 Connecting to the ESP302 through COMM. port

This port allows for RS232 communication.

3.7 Connecting to the ESP302 through Ethernet port

ESP302 supports 10/100/1000 Mbps Ethernet networking and can be accessed through:

1. Direct connection PC-to-ESP302.

The Ethernet plugs “REMOTE” or “HOST” (with static IP) can either be used.

The plug “REMOTE” has a fixed IP address (192.168.254.254). The DHCP server active on this plug will automatically configure the connected computer to make it ready for communication with the ESP302 controller.

The “HOST” plug has an adjustable static IP address (192.168.0.254 upon delivery). This plug requires the connected computer to be set to a compatible IP address value.

2. Network connection.

The Ethernet plug identified “HOST” must be used (with static IP or dynamic IP) to connect the ESP302 controller to a Network. Before connection, the controller IP setting must be set by the Network administrator.

The following cable is provided with the motion controller.

This standard Ethernet straight through black cable can be used when either connecting the device directly to a PC or to a standard network hub or switch.

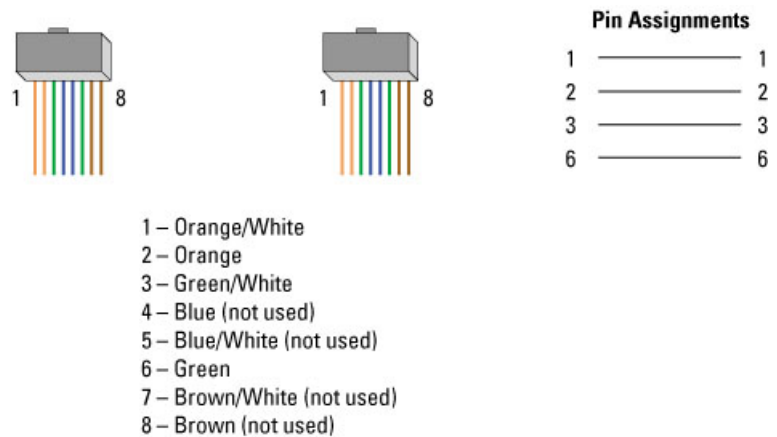

Figure 14: Straight through cables.

3.7.1 Direct Connection to the ESP302 Controller

For a direct connection between a PC and the ESP302 controller you need to use the Ethernet cable and either the REMOTE or the HOST connector at the back of the ESP302.



Figure 15: Direct connection to the ESP302 using Ethernet cable.

REMOTE Connection:

- After connecting the REMOTE connector on the back of the ESP302 to the PC, an Unidentified network will appear in your active networks found under Control Panel > Network and Sharing Center.

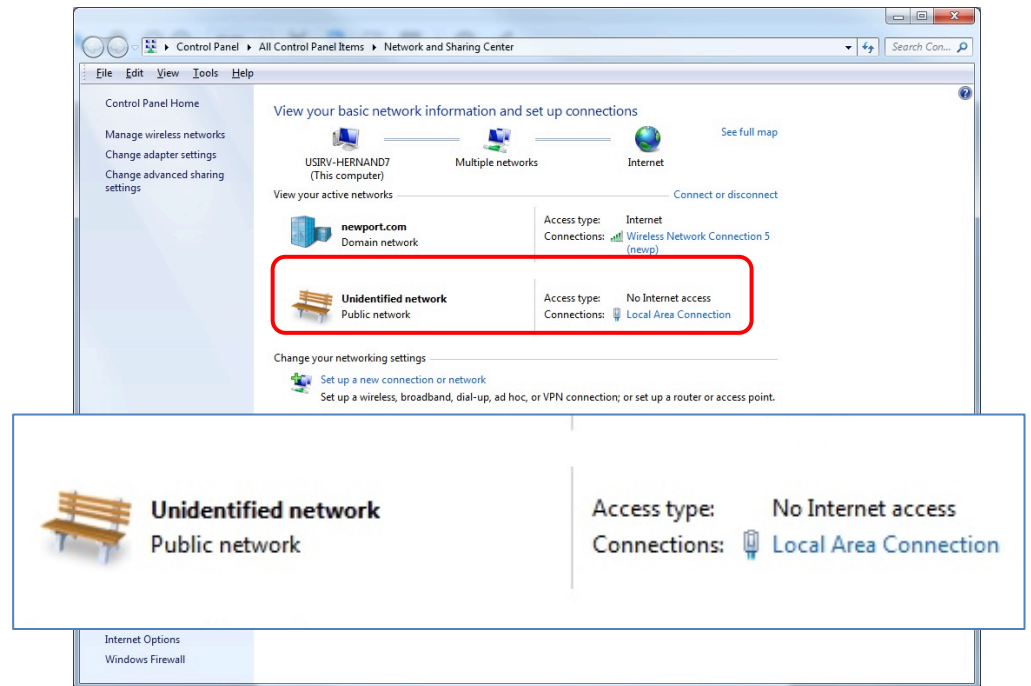

The REMOTE plug has a DHCP server which automatically assigns an IP address on the PC's Ethernet card.

Use the following procedure to ensure the Local Area Connection is set to obtain an IP address automatically.

This procedure is for the Windows 7 operating system (almost similar process for Windows 8):

- Start Button > Control Panel > Network and Sharing Center => Change adapter settings.
- Right Click on Local Area Connection Icon and select Properties.

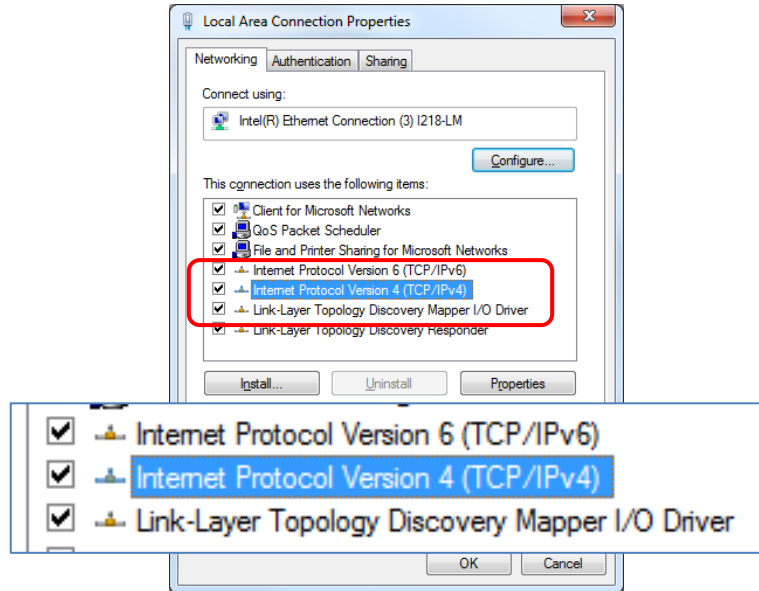

- Highlight Internet Protocol Version 4 (TCP/IPv4) and click on Properties.

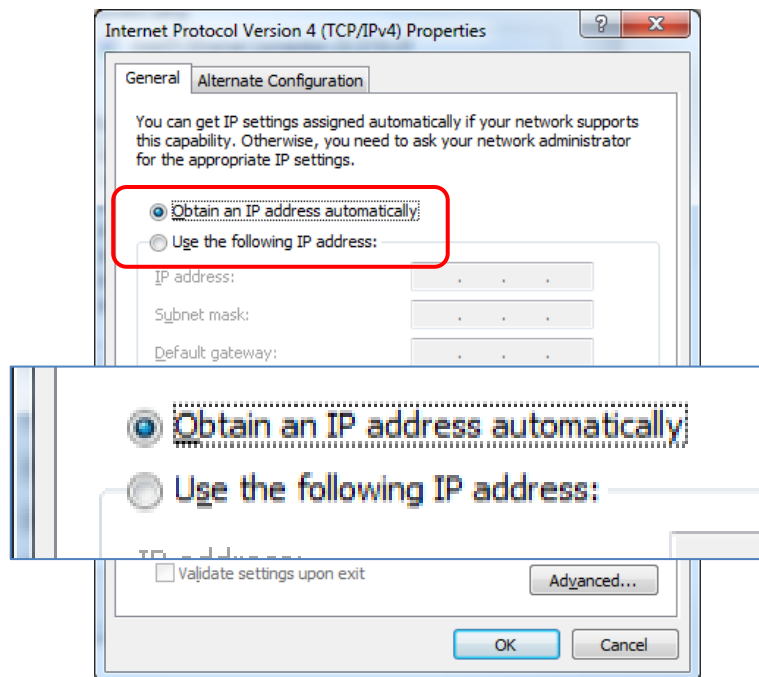

- Verify Obtain an IP address automatically is selected and click "OK".

HOST Connection:

- After connecting your PC to the HOST connector, proceed the same way but select "Use the following IP address" in the previous screenshot.
- Type a compatible network setting ("IP address: 192.168.0.100" and "Subnet mask: 255.255.255.0" for example, assuming the HOST IP address is still at the original value 192.168.0.254) and click "OK".

Procedure for connecting to the controller website:

- Open an Internet Browser and connect to <http://192.168.0.254> in case using HOST connector or connect to <http://192.168.254.254> in case using REMOTE connector

Login:

Name: **Administrator**

Password: **Administrator** (Please see the picture below).

Role: **Administrator**

NOTE

Please note that the login text is case sensitive.

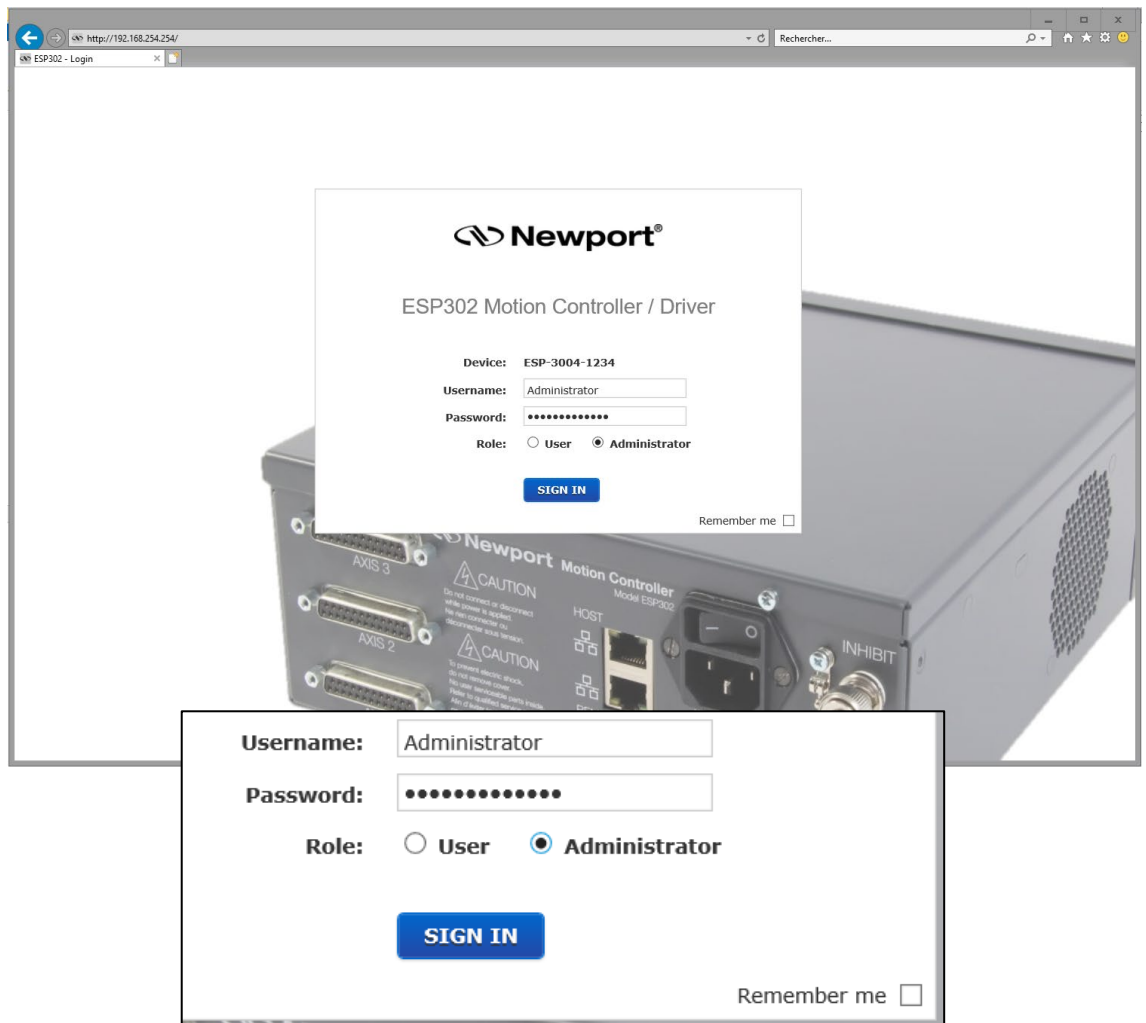

Once logged in, the ESP302 has established a direct connection to the local computer. The user interface is fully described in ESP302 User Interface manual.

If you don't want to connect the ESP302 controller through a Corporate Network you may skip to section 3.8: "Connecting the Stages".

NOTE

If you want to change the HOST IP address of the ESP302 controller, follow the explanation in the next section.

3.7.2 Connecting the ESP302 to a Corporate Network Using Static IP Configuration

Setting HOST static IP address through the front panel

- Go to "Setting/Ethernet" tab.
- Tick "static IP".
- Enter your IP address, Netmask and Gateway.
- Press "Set" to apply changes.

When complete, the new IP address is displayed on the top of the screen.

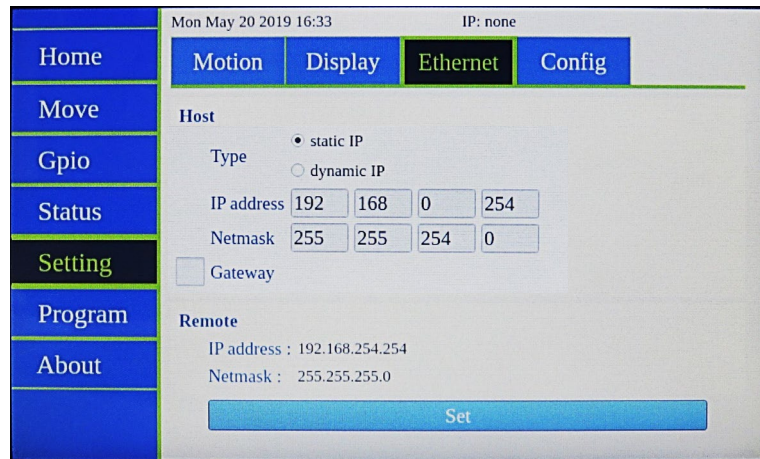

CAUTION

The Static IP address, the Netmask value and the Gateway IP address must be provided by your Network Administrator to avoid network conflicts!

NOTE

To avoid conflict with the REMOTE Ethernet plug, the IP address must be different from 192.168.254.

NOTE

For the majority of Networks, the setting above for the Netmask value will work. However, for larger networks (200 computers or more), the Netmask value address must be verified with the IT department. In most cases and for larger networks, the Netmask value is set to 255.255.0.0.

Setting HOST static IP address through the website

Once you are logged in using the previously described steps with a direct connection, you can change the IP configuration of the controller in order to connect the ESP302 over a Network.

- Get to **Controller** → **IP management** web page.
- Select Static IP configuration.
- Enter your IP address, Netmask and Gateway.

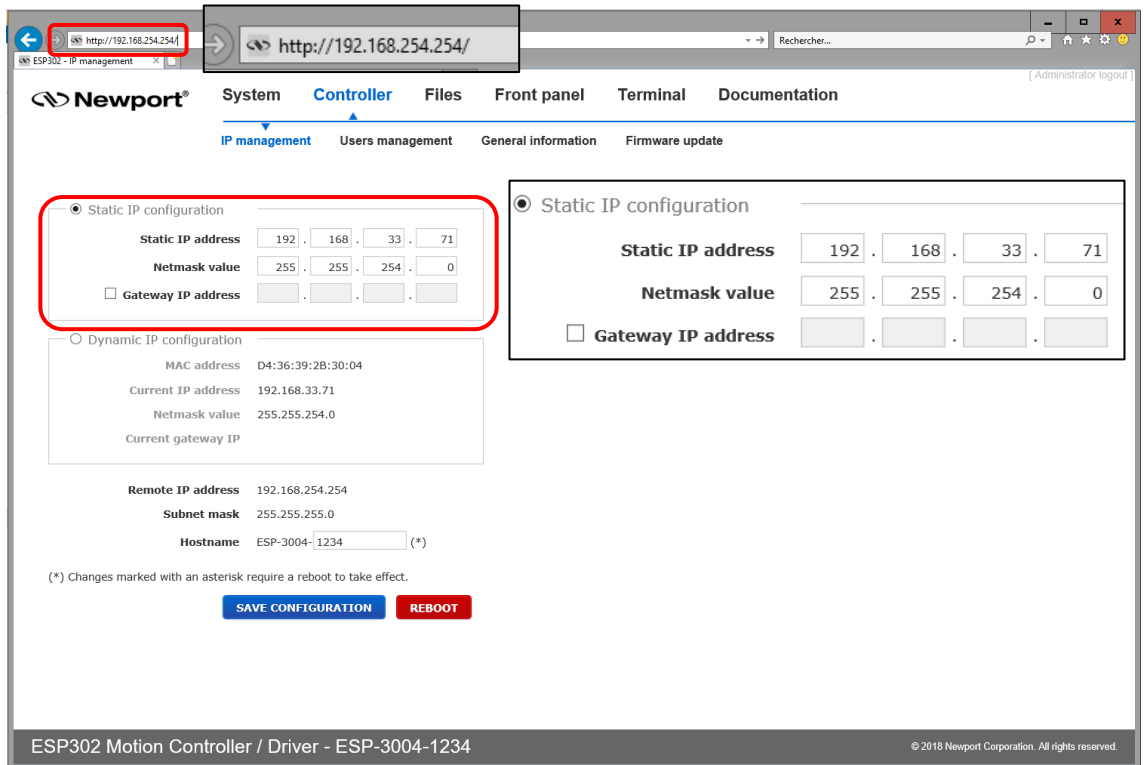

- The above shown addresses are only examples.
- Once the appropriate addresses for the Static IP configuration are set, click on “SAVE CONFIGURATION” and the following screen appears:

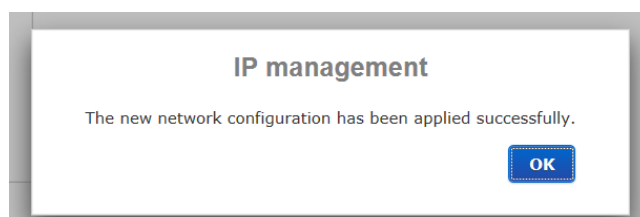

- Click "OK" and reboot the controller by clicking REBOOT.

A pop-up window appears showing “REBOOT IN PROGRESS”. When the boot sequence is complete, the user is redirected to the login page. The time to reboot is about 50 seconds.

Connecting to the ESP302

- Remove the REMOTE cable and connect your network to the HOST connector of the ESP302 controller.
- If needed, configure your PC back to its original Ethernet configuration to access your network.
- Open your internet browser and use the Static IP address.

If you don’t want to connect to the Corporate Network using the Dynamic IP Configuration, skip to section 3.8: “Connecting the Stages”.

3.7.3 Configuring the ESP302 for Connection to a Corporate Network Using Dynamic IP Configuration

Setting HOST dynamic IP address through the front panel

- Connect the Ethernet cable to the HOST connector of the ESP302 controller and to your network.
- Go to "Setting/Ethernet" tab.
- Tick "dynamic IP".
- Press "Set" to apply changes. This button turns to "Cancel (Searching)".

When complete, the IP address selected by your DHCP is displayed on the top of the screen.

- In case the ESP302 cannot negotiate an IP address from the DHCP, the search can be stopped by pressing "Cancel (Searching)". The IP address on the top of the screen becomes "None". In that case contact your IT department.

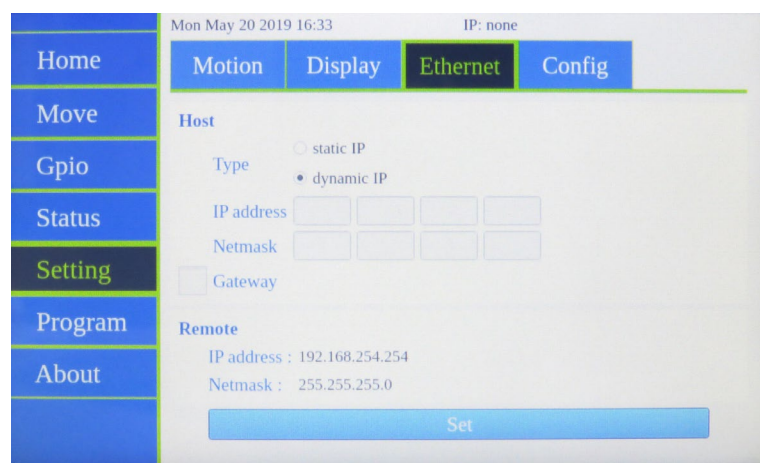

It is recommended to ask your IT department to configure the ESP302 to your network to avoid any issue with your network policies and rules.

Setting HOST dynamic IP address through the website

- Connect to REMOTE plug of the ESP302 as described in section 3.7.1: “Direct Connection to the ESP302 Controller”.
- Connect the Ethernet cable to the HOST connector of the ESP302 controller and to your network.
- Get to **Controller** → **IP management** web page
- Select dynamic IP as shown below:

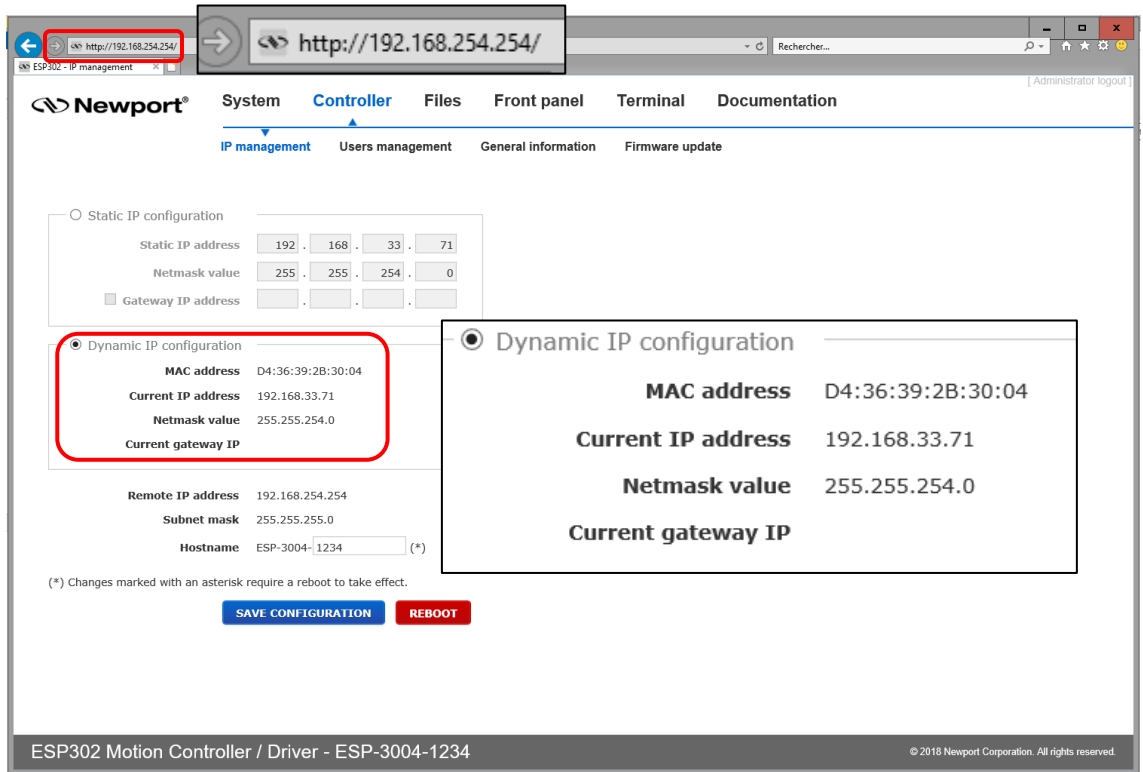

- Click the “SAVE CONFIGURATION” button and the following screen appears:

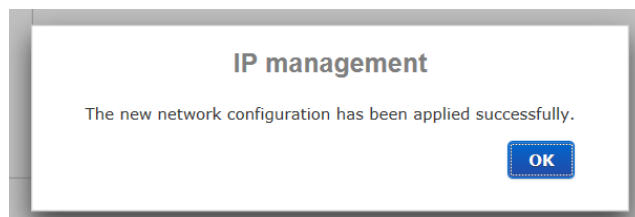

- Click "OK" and reboot the controller by clicking REBOOT.
- A pop-up window appears showing “REBOOT IN PROGRESS”. When the boot sequence is complete, the user is redirected to the login page. The time to reboot is about 50 seconds.

- Connect again to REMOTE plug

You can see the IP address delivered by your DHCP in **Controller** → **IP management**.
 In all cases, IP address is also displayed in **Controller** → **General information**.

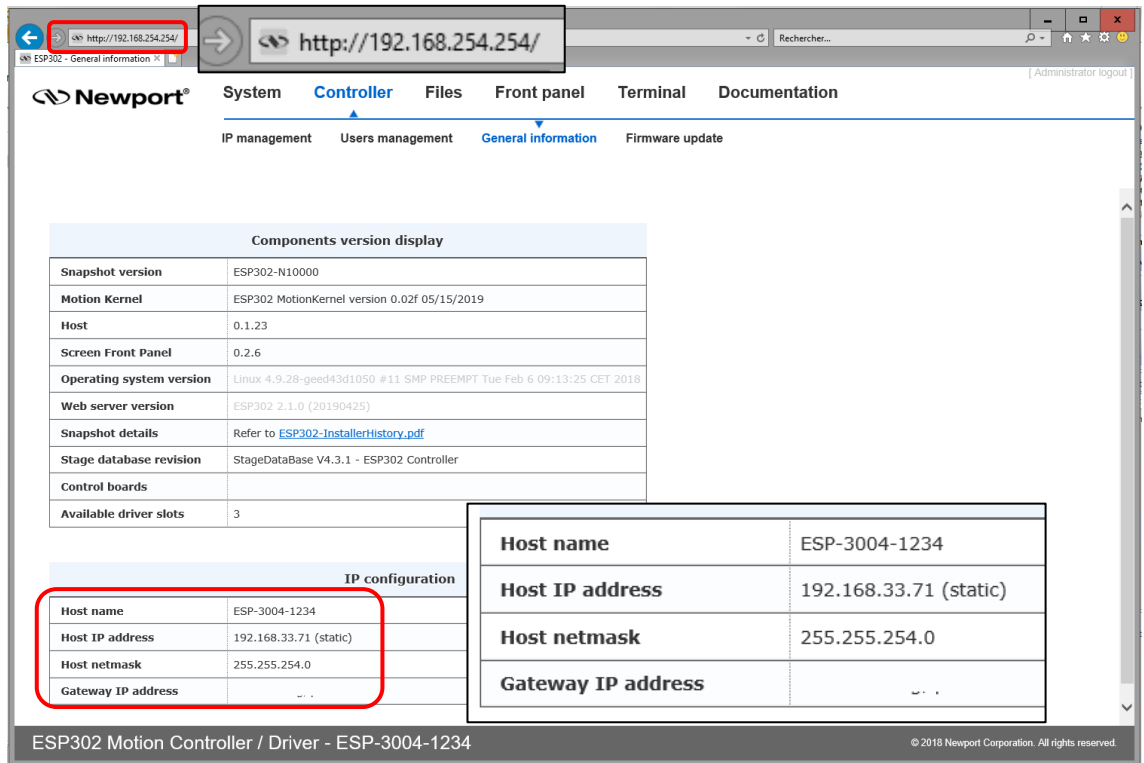

The IP address is displayed above followed by "(static)" or "(DHCP)" depending on the configuration.

- In case the ESP302 cannot negotiate an IP address from the DHCP no address will be reported. In that case contact your IT department.
- Check with your IT department that the lease time set at the DHCP is longer than the time you plan to leave the ESP302 switched off otherwise you will lose your dynamic address and will need to connect to the REMOTE to know the new assigned one by the DHCP.

Connecting to the ESP302

- Remove the REMOTE cable and, if needed, configure your PC back to its original Ethernet configuration, you have saved before modification.
- Make sure that the Ethernet cable is connected to the HOST connector of the ESP302 controller and to your network.
- Open your internet browser and use the dynamic IP address.

NOTE

Do not use Dynamic IP configuration if your DHCP server uses Windows NT 4.0.

3.7.4 Recovering a Lost IP Configuration

If you want to recover a lost IP configuration, simply use the ESP302 front panel and go to "Setting/Ethernet" tab to get the present dynamic IP address allocated by your network.

3.7.5 Testing your ESP302-PC Connection and Communication

To check if the ESP302 communicates with to the host computer, send a ping message from the computer to the ESP302. This is done through the Windows menu: Start->Run->, then type: ping + IP address of the ESP302. See the example below for the IP address 192.168.254.254:

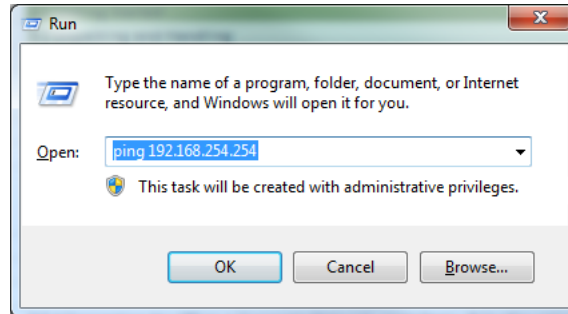

If the ESP302 is connected and communicates properly, it replies in the terminal window that appears after clicking on the OK button:

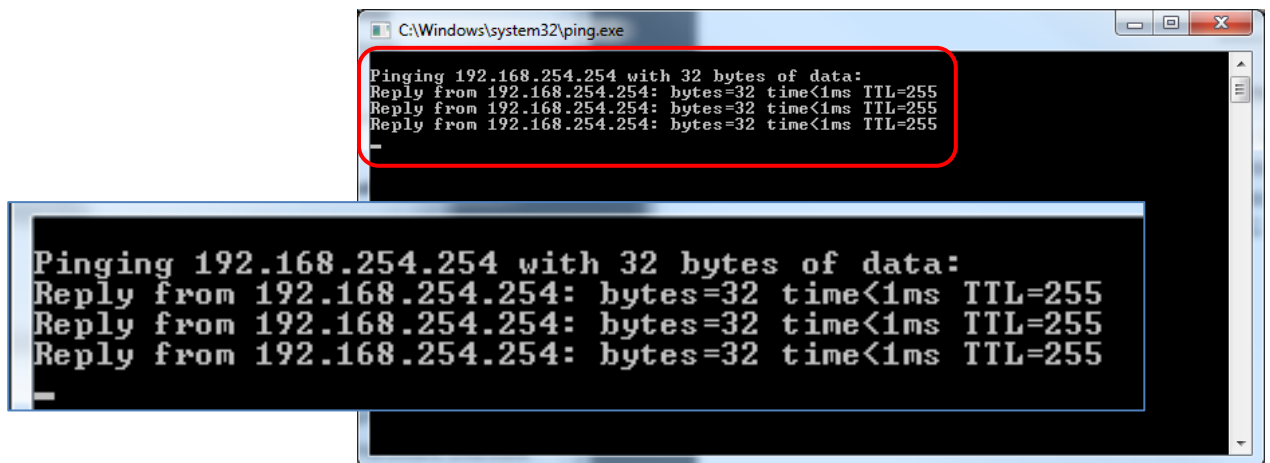

If the ESP302 controller is not communicating, the window displays that the time delay of the request is exceeded. Ensure that the correct cable and IP addresses are set properly.

3.8 Connecting the Stages



CAUTION

Never connect/disconnect stages while the ESP302 controller is powered on.



CAUTION

Mount the stage(s) on a flat, stable surface before connecting to the ESP302 controller.

- Power off the controller.
- Carefully connect the supplied cable to the stage and to the appropriate axis connector at the rear of the controller. Secure both connections with the locking thumbscrews.

The ESP302 controller is only intended to be used with Newport ESP-compatible stages which are electrically and physically compatible. ESP-compatible stages are visually identified with a blue “ESP Compatible” sticker on the stage. If an ESP-compatible motion system was purchased, all necessary hardware to connect the stage with the ESP302 controller is included. The stage connects to the ESP302 via a shielded custom cable that carries all the power and control signals (encoder, limits, and home signals). The cable is terminated with a standard SUB-D25 connector.

3.9 Configuring the Controller

- Power on the controller.

Shortly after the power is switched on, the ESP302 will perform a start-up sequence and momentarily display: "Newport ESP302".

With ESP-compatible stages, the configuration of each axis is identified automatically by the ESP302 at power up. See ESP302 User Interface Manual for more details.

The boot sequence is described below:

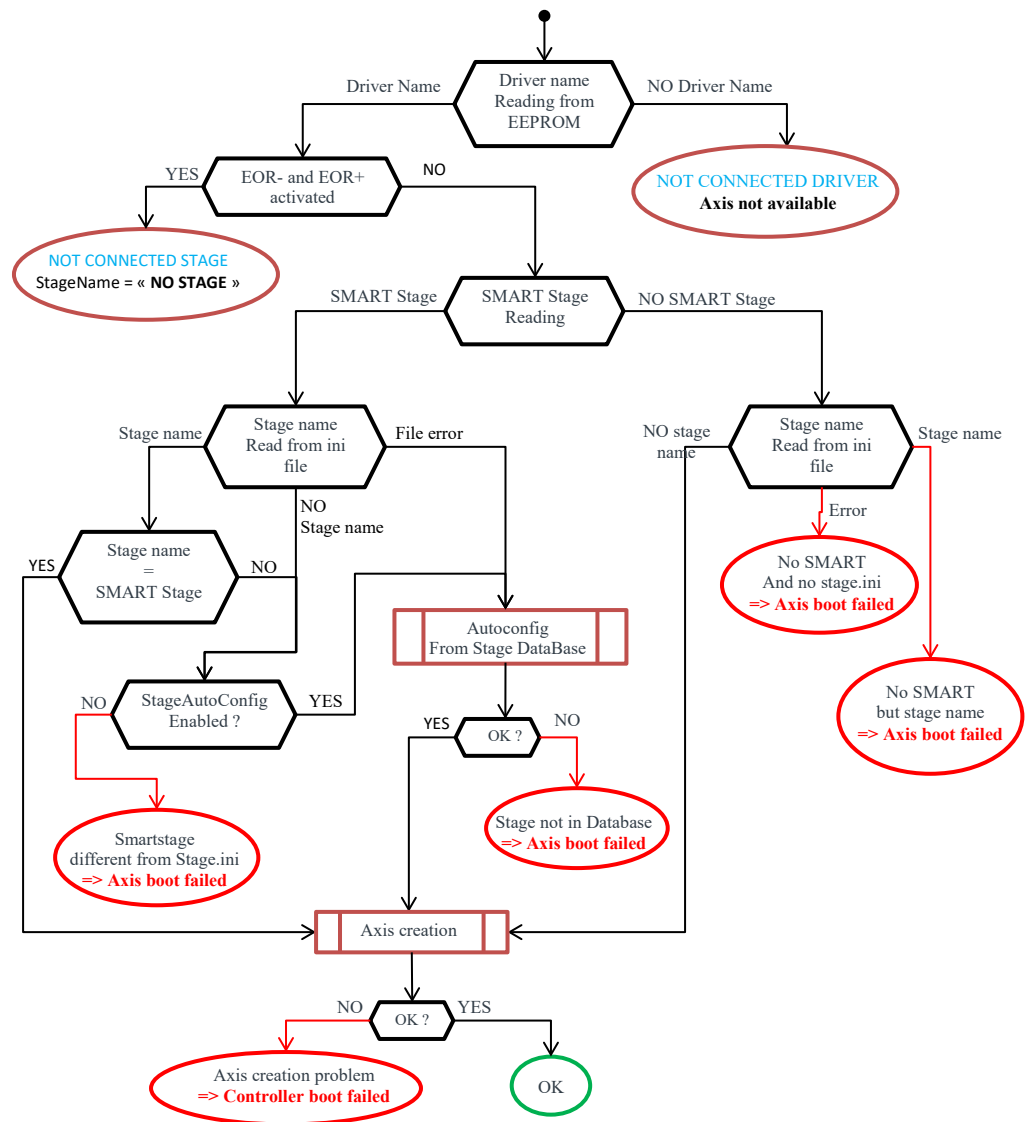

3.9.1 Dummy Stages

“Dummy stage” configuration can be used to simulate a stage. This feature allows users to configure and test the system’s behavior without having a real stage connected on the axis.

To configure your system with a number of dummy stages see ESP302 User Interface Manual.

3.9.2 Configuration files

StageX.ini files:

ESP302 controller automatically creates/updates a stage configuration file for each axis upon power-up (Stage1.ini, Stage2.ini and Stage3.ini). This file is only accessible through SFTP connection and should not be modified.

System.ini file:

ESP302 controller also automatically creates/updates a system configuration file upon power-up (System.ini file). This file is only accessible through SFTP connection and should not be modified.

3.10 Using the controller

Refer to ESP302 User Interface Manual for more information about controller user interface.

See also ESP302 Features Manual for explanations about controller functions and operation.

3.11 Documentation

Under the webpage Documentation, users can open and download ESP302 manuals and drivers.

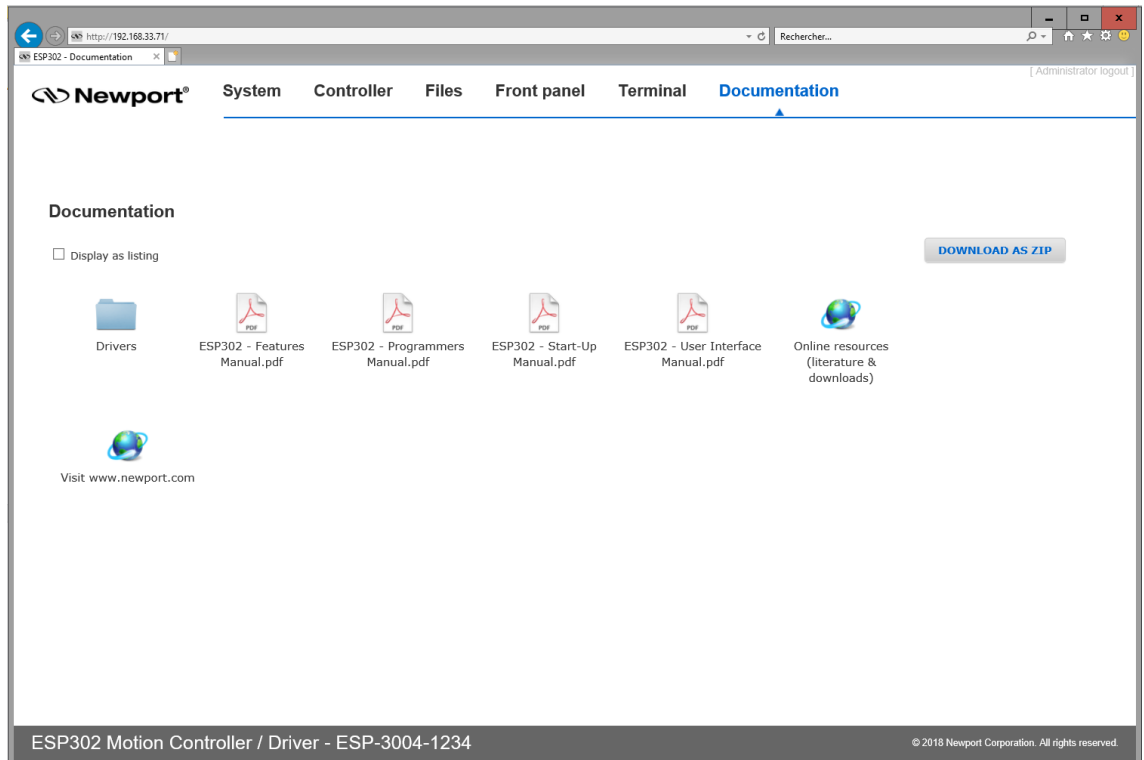

3.12 SFTP (Secured File Transfer Protocol) Connection

All usual file management can be done from the controller website interface. Nevertheless, SFTP connection is another option to manage file transfers from an external application.

Example, using Filezilla for secured FTP transfer:

- Run Filezilla and open Site Manager
- Create a new site, select SFTP Protocol
- Enter IP address, login and password

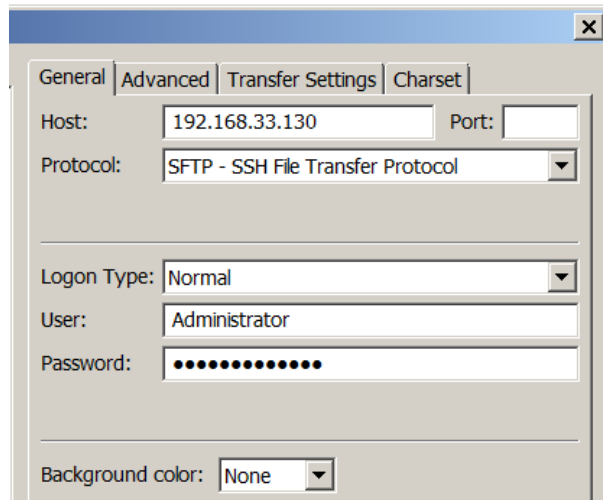

- Click Connect

The folders of the ESP302 controller are displayed (see below). Browse through the different folders and transfer data from or to your host PC.

When connected to the controller with FTP as Administrator, the user has access to configuration files. The Administrator home directory contains folders: .mc, Config, DefaultConfig, Firmware and Public.

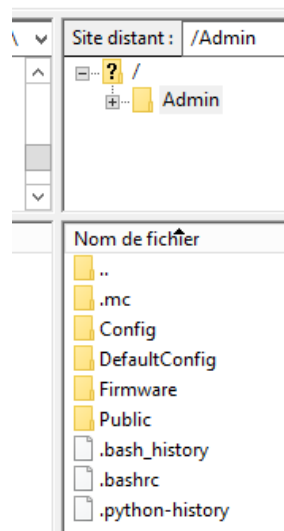

When connected to the controller with FTP as an ordinary user such as Anonymous, the user has access to Public files. This directory contains folders: CoeDump, Gathering, Logs, Progs and Scripts.

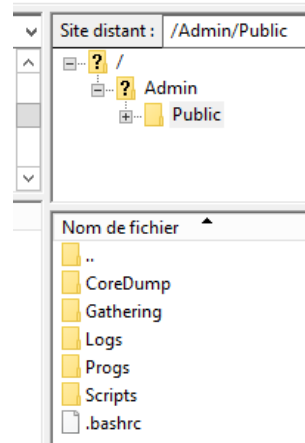

You can also use “puTTY psftp.exe” for secured FTP transfer.

3.13 Samba Microsoft SMB/CIFS Networking Protocol

A secured protocol (Samba) has been implemented and also allows the controller Public folder (this folder only) to be attached and detached to the computer as a network drive.

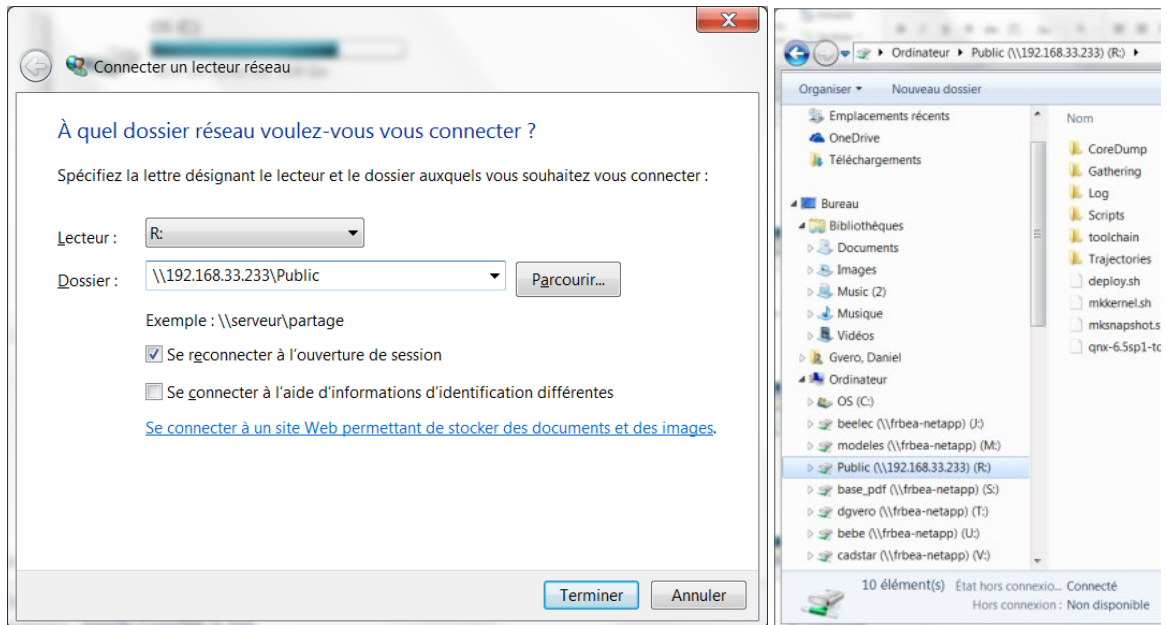

3.14 System Shut-Down

To shut down the system entirely, perform the following procedure:

- Wait for the stage(s) to complete their moves and come to a stop.
- Turn off the power using the power switch located above the power cord at the back of the controller.

4.0 Maintenance and Service

4.1 Enclosure Cleaning

The ESP302 Controller/Driver should only be cleaned with a sufficient amount of soapy water solution. Do not use an acetone or alcohol solution; this will damage the finish of the enclosure.

4.2 Obtaining Service

The ESP302 Controller/Driver contains no user serviceable parts. To obtain information regarding factory service, contact Newport Corporation or your Newport representative and be ready with the following information:

- Instrument model number (on front panel) and original order number.
- Instrument serial number (on bottom panel).
- Snapshot version (VE command or "Controller/General information" on website)
- Description of the problem.

If the ESP302 is to be returned to Newport Corporation, a Return Number will be issued, which should be referenced in the shipping documents.

Complete a copy of the Service Form found at the end of this Manual and include it with your shipment.

4.3 Troubleshooting

For troubleshooting, the user can query different error and status information from the controller. The ESP302 controller provides the controller, axis or driver status (TS command), controller activity (TX), hardware status (PH).

If there is an error during command execution, the controller will return an error code. The TB and TE commands can be used to retrieve description or code of the error.

NOTE

Refer to the Programmer's Manual for a complete list of status and error codes. Also refer to User Interface Manual for troubleshooting the ESP302 controller with the help of its web utilities.



Appendix

5.0 Appendix A: Hardware

5.1 Controller

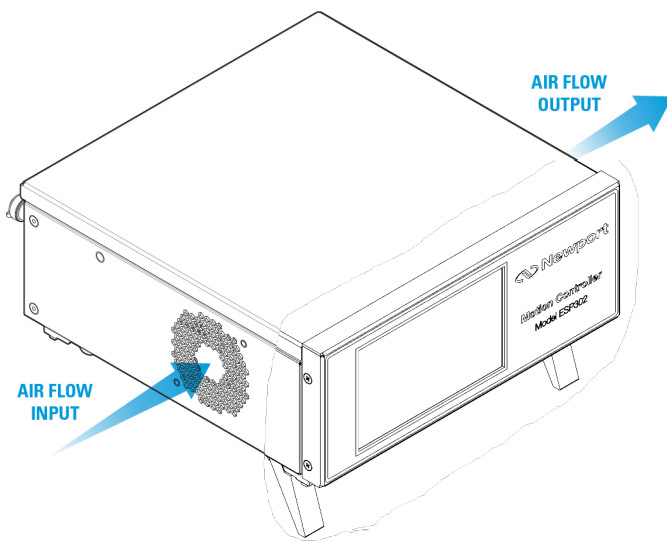
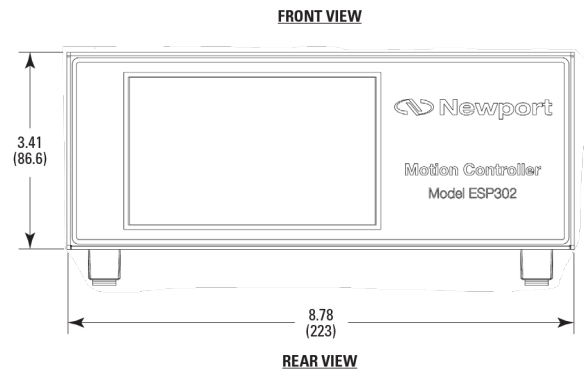
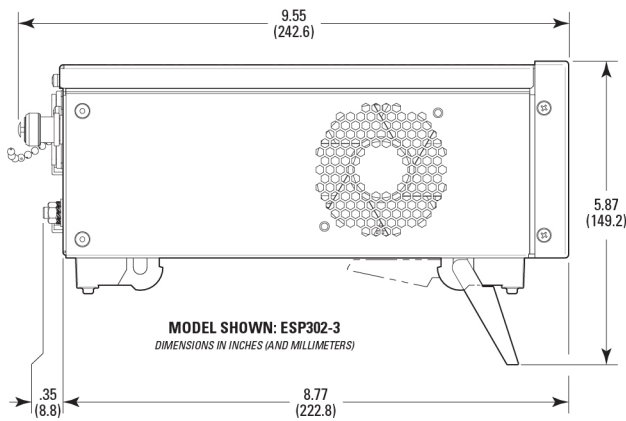

Weight: 3.0 kg (6.6 lb)
Air flow: 17.6 CFM

5.2 Rear Panel Connectors

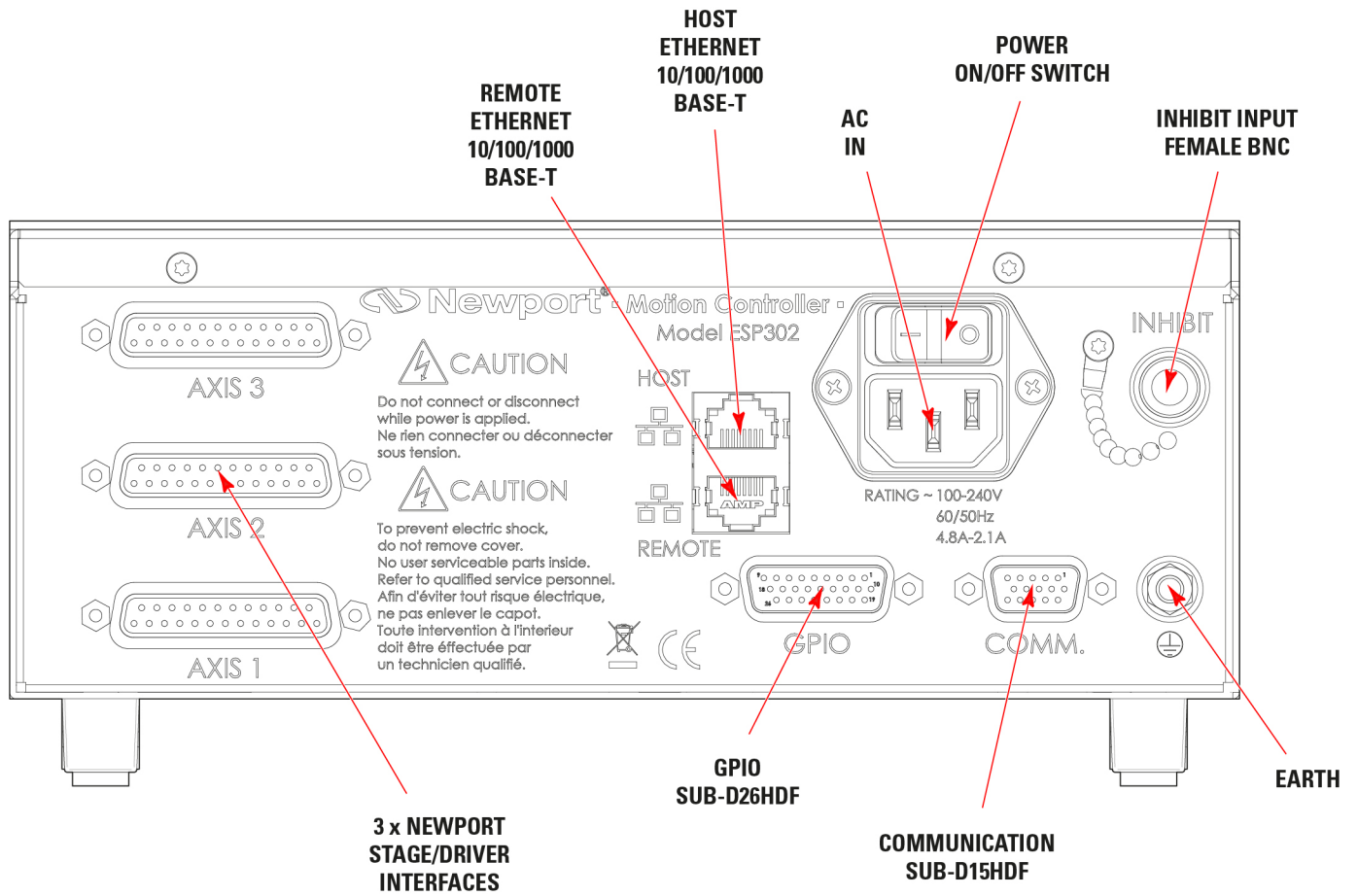

Figure 16: Rear Panel.

6.0 Appendix B: General I/O Description

This chapter briefly describes all ESP302 signal types and details each of the ESP302 connector interfaces.

6.1 Digital I/O's

All digital I/Os are TTL compatible:

- All digital I/Os are not isolated, but are referenced to electrical ground (GND).
- Input levels must be between 0 V and +5 V.
- Output levels are +5 V.

All digital I/Os are refreshed asynchronously on user requests. Therefore, digital inputs or outputs have no refresh rate.

Typical delay is a few μ s due to priorities made to other functions.

For firmware compatibility reasons, I/Os are grouped in two busses (GPIO1 and GPIO2), each bus can be configured independently in input or output mode (default input).

6.1.1 GPIO Connector



NOTE

Mating connector: Male SUB-D26HD with UNC4/40 lockers.

GPIO			
Pin #	Function	Pin #	Function
1	+5 V (fused: max 100 mA)	14	GND
2	GPIO1.DI1 or GPIO1.DO1	15	GND
3	GPIO1.DI2 or GPIO1.DO2	16	GND
4	GPIO1.DI3 or GPIO1.DO3	17	GND
5	GPIO1.DI4 or GPIO1.DO4	18	GND
6	GPIO1.DI5 or GPIO1.DO5	19	GPIO2.DI1 or GPIO2.DO1
7	GPIO1.DI6 or GPIO1.DO6	20	GPIO2.DI2 or GPIO2.DO2
8	GPIO1.DI7 or GPIO1.DO7	21	GPIO2.DI3 or GPIO2.DO3
9	GPIO1.DI8 or GPIO1.DO8	22	GPIO2.DI4 or GPIO2.DO4
10	GND	23	GPIO2.DI5 or GPIO2.DO5
11	GND	24	GPIO2.DI6 or GPIO2.DO6
12	GND	25	GPIO2.DI7 or GPIO2.DO7
13	GND	26	GPIO2.DI8 or GPIO2.DO8

Figure 17: GPIO connector.

6.2 Axes

6.2.1 Digital Encoder Inputs

All digital encoder inputs are RS-422 standard compliant:

- All digital encoder signals are not isolated, but are referenced to the electrical ground (GND).
- Encoder signals must be differential pairs. Encoder inputs have a terminating impedance of 120 Ω.
- Inputs are always routed on differential pairs. For a high level of signal integrity, we recommend using shielded twisted pairs of wires for each differential signal.
- Encoder power supply is +5 V @ 250 mA maximum (referenced to the electrical ground) and is sourced directly by the driver board. The +5 V power supply is low noise (approximately 20 mVpp), fuse protected up to 500 mA/plug, and supplies 5.13 V without load.

6.2.2 Digital Servitudes

All servitude inputs are TTL compatible:

- All servitude inputs are not isolated, but are referenced to the electrical ground (GND).
- Input levels must be between 0 V and +5 V.

All servitude inputs are refreshed synchronously with the ESP302 servo rate.

All servitude inputs are identical.

All servitude inputs expect normally closed sensors referenced to ground (input is activated if the sensor is open) and have internal 2.2 kΩ pull up resistors to the +5 V.

6.2.3 Axis Connectors

MOTOR DRIVER 1 TO 3

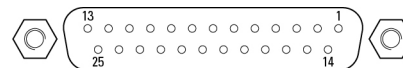

NOTE

Mating connector: Male SUB-D25 with UNC4/40 lockers.

MOTOR DRIVER				
Pin #	DC Motor	Stepper Motor	Pin #	All Motors
1	N.C.	+ Phase 1	13	Origin
2	N.C.	+ Phase 1	14	GND
3	N.C.	- Phase 1	15	Index
4	N.C.	- Phase 1	16	GND
5	Motor+	+ Phase 2	17	+ Travel Limit
6	Motor+	+ Phase 2	18	- Travel Limit
7	Motor-	- Phase 2	19	Encoder A
8	Motor-	- Phase 2	20	Encoder B
9	N.C.	N.C.	21	+5V
10	N.C.	N.C.	22	GND
11	N.C.	N.C.	23	Encoder /A
12	N.C.	N.C.	24	Encoder /B
			25	/Index

Figure 18: Motor driver connectors.

Motor +	This output must be connected to the positive lead of the DC motor. The voltage seen at this pin is pulse-width modulated with maximum amplitude of 47 VDC.
Motor -	This output must be connected to the negative lead of the DC motor. The voltage seen at this pin is pulse-width modulated with maximum amplitude of 47 VDC.
+ Phase 1	This output must be connected to Winding A+ lead of a two-phase stepper motor. The voltage seen at this pin is pulse-width modulated with maximum amplitude of 47 VDC.
- Phase 1	This output must be connected to Winding A- lead of a two-phase stepper motor. The voltage seen at this pin is pulse-width modulated with maximum amplitude of 47 VDC.
+ Phase 2	This output must be connected to Winding B+ lead of a two-phase stepper motor. The voltage seen at this pin is pulse-width modulated with maximum amplitude of 47 VDC.
- Phase 2	This output must be connected to Winding B- lead of a two-phase stepper motor. The voltage seen at this pin is pulse-width modulated with maximum amplitude of 47 VDC.
+ Travel limit	This input is pulled-up to +5 V with a 2.2 k Ω resistor by the controller and represents the stage positive direction hardware travel limit.
- Travel limit	This input is pulled-up to +5 V with a 2.2 k Ω resistor by the controller and represents the stage negative direction hardware travel limit.
Encoder A & /A	These A and /A inputs are differential inputs. Signals are compliant with RS422 electrical standard and are received with a MC3486 differential line receiver. A resistor of 120 Ω adapts the input impedance. The A and /A encoder signals originate from the stage position feedback circuitry and are used for position tracking.
Encoder B and /B	These B and /B inputs are differential inputs. Signals are compliant with RS-422 electrical standard and are received with a MC3486 differential line receiver. A resistor of 120 Ω adapts the input impedance. The B and /B encoder signals originate from the stage position feedback circuitry and are used for position tracking.
Index & /Index	These Index and /Index inputs are differential inputs. Signals are compliant with RS422 electrical standard and are received with a MC3486 differential line receiver. A resistor of 120 Ω adapts the input impedance. The Index and /Index signals originate from the stage and are used for homing the stage to a repeatable location.
GND	Ground reference.
Origin	This input is pulled-up to +5 V with a 2.2 k Ω resistor by the controller. The Origin signal originates from the stage and is used for homing the stage to a repeatable location.
+5 V (0.25A max.)	+5 VDC supply is available from the driver. This supply is provided for stage home, index, travel limit, and encoder feedback circuitry.

6.3 Communication Port

6.3.1 COMM. Connector

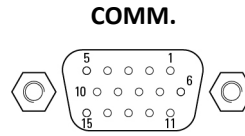

NOTE

Mating connector: Male SUB-D15HD with UNC4/40 lockers.

COMM			
Pin #	Function	Pin #	Function
1	RS232 RXD	9	reserved
2	RS232 TXD	10	reserved
3	reserved	11	RS232 RTS
4	reserved	12	RS232 CTS
5	reserved	13	reserved
6	RS232 DTR	14	reserved
7	GND	15	reserved
8	GND		

Figure 19: COMM. connector.

NOTE

To match with standard serial cable, a male SUB-D15HD to female SUB-D9 adapter can be ordered separately.

Serial port parameters:

- RS232-C
- 19200 bauds, 8 bits, N, 1

7.0 Appendix C: Power Inhibit Connector

7.1 Description

Inhibit in ESP302 is a female BNC Connector intended for wiring a remote STOP ALL switch. (If not used, the BNC plug must remain in place to allow operation)



The BNC pin is connected to ESP302 inhibit and BNC outer shell is connected to GND. For normal operation of the ESP302, the Inhibit must be connected to GND in order to work. When inhibit is open the motor power supply is switched OFF

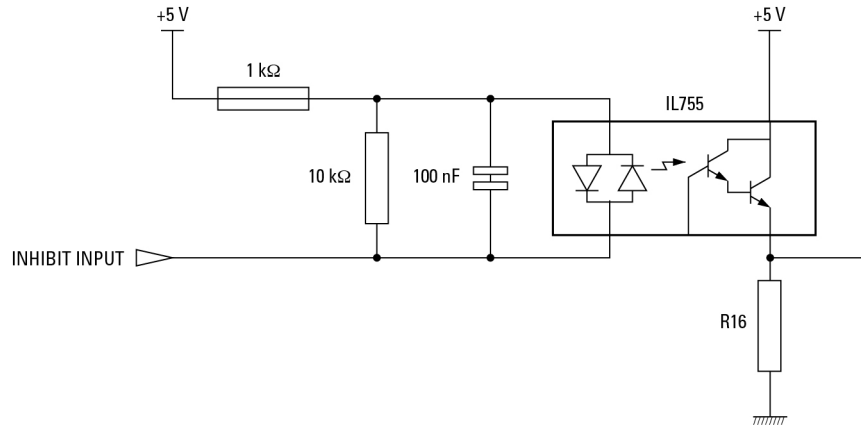

Figure 20: Inhibition connector.



Visit Newport Online at:
www.newport.com

North America & Asia

Newport Corporation
1791 Deere Ave.
Irvine, CA 92606, USA

Sales

Tel.: (800) 222-6440
e-mail: sales@newport.com

Technical Support

Tel.: (800) 222-6440
e-mail: tech@newport.com

Service, RMAs & Returns

Tel.: (800) 222-6440
e-mail: service@newport.com

Europe

MICRO-CONTROLE Spectra-Physics S.A.S
9, rue du Bois Sauvage
91055 Évry CEDEX
France

Sales

Tel.: +33 (0)1.60.91.68.68
e-mail: france@newport.com

Technical Support

e-mail: tech_europe@newport.com

Service & Returns

Tel.: +33 (0)2.38.40.51.55

